

La forma della luce

Catalogo Tecnico  
Technical Catalog  
2024

PANZERI

Le carte utilizzate per la stampa di questo listino sono riciclate e certificate FSC®. La carta della copertina è un prodotto unico nel suo genere, che pur avendo una rilevante presenza di riciclo nell'impasto, grazie all'utilizzo di fibre di cotone mantiene una particolare morbidezza alla superficie. Carta composta da 25% di pura cellulosa certificata FSC®, 25% fibre di riciclo certificate FSC®, 40% di cellulosa CTMP e 10% fibre di cotone.

The papers used for printing this price list are recycled and certified FSC®. The cover page is a product unique in its genre. Despite a relevant presence of recycled material in the blend, it maintains an exceptional surface smoothness thanks to the adding of cotton fibers. Composite papers made of 25% of pure cellulose certified FSC®, 25% recycled fibers certified FSC®, 40% CTMP cellulose, and 10% cotton fibers.



# PANZERI

CATALOGO TECNICO 04.2024  
TECHNICAL CATALOG 04.2024

<b>INDOOR</b>	11
<b>CANOPIES AND OFFSET</b>	93
<b>ACOUSTIC</b>	103
<b>OUTDOOR</b>	107
<b>PROFILES</b>	116
<b>SPOTLIGHT</b>	140
<b>RECESSED</b>	166
<b>LED PANEL</b>	185
<b>ELECTRIC OPTIONS</b>	187
<b>TECHNICAL INFORMATION</b>	193

# INTERNO / INDOOR



432 WAYS  
12



NEW



ALDECIMO  
15



APP  
16



ARENA  
17



BELLA  
19



BELLA VESTITA  
21



BOW  
22



BROOKLYN LINE  
26



BROOKLYN ROUND  
27



BROOKLYN CANOPIES  
28



CANDLE  
30



CARL  
31



CARL2  
32



CARMEN  
33



CLIO  
64



CROSS  
34



DIP  
35



NEW



EMMA  
63



FIREFLY IN THE SKY  
37



GIANO  
38



GILBERT  
40



GINEVRA  
41



GOLDEN RING  
42



GONG  
46



GONIO  
47



NEW



HILOW  
48



HILOW LINE  
50



JACKIE  
52



JAY  
54



LOLA  
55



MURANÉ  
56



NEW



MURANÉ R  
59



NEW



OLIVIA  
62



OPUNTIA  
65



ROMA  
66



NEW

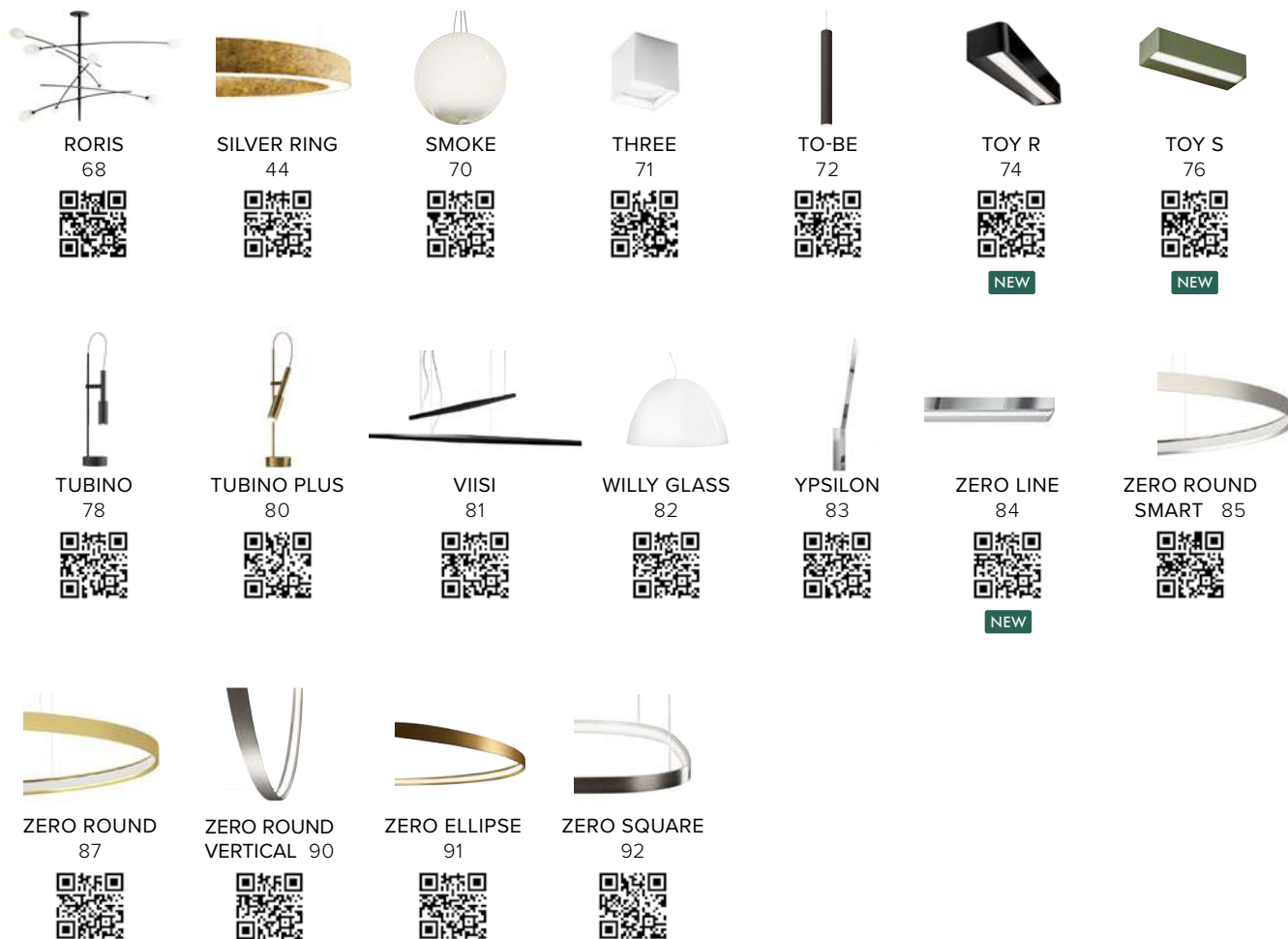

**ROSONI E DECENTRAMENTI / OFFSET AND CANOPIES**



---

## ACUSTICA / ACOUSTIC



ARENA ACOUSTIC  
104



PHI  
105



ZERO ROUND ACOUSTIC  
106



---

## ESTERNO / OUTDOOR



DIP  
108



NEW



FIREFLY IN THE SKY  
109



RALPH  
111



ROMA  
113



NEW



VENEXIA  
114



---

## PROFILI / PROFILES



BROADWAY  
136



BRONX  
117



BROOKLYN  
119



BROOKLYN OUT  
123



BROOKLYN TRIM  
121



CORNER  
125



GIANO  
127



HARLEM  
130



KIPS  
132



KIPS ROUND  
131



MANHATTAN  
133



NOOK  
137



TRIBECA  
138



## PROIETTORI / SPOTLIGHT



ASTORIA IN  
146



ASTORIA OUT  
148



ASTORIA LINE  
144



ASTORIA SPOT  
145



ASTORIA 8  
141



NEW



ASTORIA 5  
142



ASTORIA 3  
143



NEW



QUEENS  
155



QUEENS 45  
151



QUEENS 25  
152



QUEENS 20  
153



QUEENS 10  
154



SOHO IN  
162

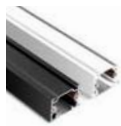

SOHO OUT  
164



SOHO LINE  
161



SOHO S 15  
160



SOHO 20  
157



SOHO 10  
158



SOHO 5  
159



## INCASSI / RECESSED



CLICK CLACK  
167



EAST  
168



EDDIE  
174



JAMES  
175



JARVIS  
176



JESSIE  
177



JOE  
184



MOAI  
173



NICK  
178



RALLY TRIM  
180



SID  
182



STEP BY STEP  
171



TAYLOR  
183



---

## LED PANEL



JERSEY  
186

---

## ELECTRIC OPTIONS



188

---

## TECHNICAL INFORMATION

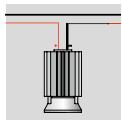

193



# TIPOLOGIE DI INSTALLAZIONE / MOUNTING TYPES

SOSPENSIONE / SUSPENSION    PARETE / WALL    SOFFITTO / CEILING    TAVOLO / TABLE    TERRA / FLOOR    BINARIO / TRACK

## DESIGN

432 WAYS			•			
ALDECIMO		•				
APP		•				
ARENA	•					
BELLA	•	•		•		
BOW		•	•			
BROOKLYN LINE	•					
BROOKLYN ROUND	•	•	•			
CANDLE	•					•
CARL			•			
CARL2		•	•			
CARMEN		•	•			
CLIO	•					•
CROSS		•				
DIP	•	•	•		•	
EMMA	•					•
FIREFLY in the sky				•		
GIANO	•	•				
GILBERT	•		•	•		•
GINEVRA	•	•	•			
GONIO		•				
GOLDEN RING	•					
GONG	•					
HILOW	•	•	•			
HILOW LINE		•			•	
JACKIE		•	•	•	•	
JAY		•				
LOLA		•	•			
MURANÈ	•	•	•			
MURANÈ R	•					
OLIVIA	•					•
OPUNTIA		•		•		
ROMA	•	•			•	
RORIS		•	•	•		
SILVER RING	•	•	•			
SMOKE	•					•
THREE		•	•			
TO-BE	•		•			
TOY R		•				
TOY S		•				
TUBINO	•	•	•	•	•	
TUBINO PLUS				•		
VIISI	•				•	
WILLY GLASS	•					•
YPSILON		•				
ZERO LINE		•	•			
ZERO ELLIPSE	•					
ZERO ROUND	•	•	•			
ZERO ROUND VERTICAL	•					
ZERO SQUARE	•					

## ACUSTICA

ARENA ACOUSTIC	•					
PHI	•					
ZERO ROUND ACOUSTIC	•					

## OUTDOOR

DIP					•	
FIREFLY in the sky				•	•	
RALPH	•	•		•	•	
ROMA					•	
VENEXIA	•	•			•	

# VADEMECUM LETTURA LISTINO / HOW TO READ PRICE LIST

**Codice Qr**  
Qr-code

**Nome della famiglia**  
Family name

**Foto**  
Picture

**Progettista e anno, eventuale registrazione**  
Designer, year and possible registration

**Descrizione**  
Description

**ZERO**

Studio Tecnico Panzeri 2012 Registered Design

Lampade da parete/coffitto in metallo bianco, cromo, bronzo, ottone satinato e foglia oro complete di LED e driver. Wall/ceiling lamps in white metal, chrome, bronze, matt brass and gold leaf complete with LED and driver.

**Tipologia di emissione luminosa**  
Light output

**Dati e caratteristiche tecniche**  
Data and technical details

**Potenza e flusso luminoso effettivi**  
Effective power and luminous flux

**Peso netto in kg**  
Net price in kilos

CODICE CODE	FONTE LUMINOSA LIGHT SOURCES	kg	€
A03501.050.0401	Potenza assorbita apparecchio / Luminaire power consumption 11W Flusso luminoso apparecchio / Luminaire luminous flux 613lm 3000K Ra90 220-240V AC ON-OFF	1,37	277,00
A03517.050.0401			350,00
A03519.050.0401			326,00
A03521.050.0401			369,00
A03522.050.0401			338,00
P23201.180.0402	Potenza assorbita apparecchio / Luminaire power consumption 109W Flusso luminoso apparecchio / Luminaire luminous flux 5931lm 3000K Ra>90 220-240V AC dimmable (DALI/Push DIM)	3,38	1.398,00
P23202.180.0402			1.608,00
P23219.180.0402			1.608,00

**Disegno con dimensioni in cm e pollici**  
Drawing with dimensions in cm and inches

**Possibilità di installazione**  
Fixing prospect

Fotometrie disponibili [www.panzeri.it](http://www.panzeri.it) / Photometric data available at [www.panzeri.it](http://www.panzeri.it)

**CODICI COLORI DISPONIBILI / COLOUR CODES AVAILABLE**

01 bianco white      02 nero black      19 ottone satinato matt brass

Disponibili a richiesta LED 2700K / On request 2700K LED available

**Prezzo di listino a seconda della finitura**  
Price list according to finishing

**Eventuali temperature di colore a richiesta**  
Possible light colour temperature on demand

Finiture disponibili  
Finishing available

## SIGNIFICATO DELLA CODIFICA / CODE MEANING

Vedi tabella a fianco / See table on side

Tipologia di installazione	Numero di famiglia	Dimensione caratteristica	Qualità della luce	Elettrificazione	Descrizione	
XG	231	01	360	00	99	Profilo da incasso Brooklyn round 100 360° No led No alimentazione / Recessed track Brooklyn round 100 white 360° No led No Electricity
A	016	37	025	01	01	Lampada da parete Toy acciaio inox lucido 25 cm Led 3000K Ra80 Alimentazione standard / Wall lamp Toy Polished stainless steel 25 cm 3000K Ra80 Standard power supply
C	077	03	000	04	13	Lampada da tavolo Jackie Rossa Led 3000K Ra90 lot step dim / Table lamp Jackie Red 3000K Ra90 lot step dim
L	081	21	180	01	02	Sospensione Golden Ring Foglia oro diametro 180 cm Led 3000K Ra80 DALI/PUSH DIM / Suspension Golden Ring gold leaf diameter 180 3000K Ra80 DALI/PUSH DIM

## LEGENDA / LEGEND

- Emissione luminosa diretta e indiretta  
Direct and indirect light emission
- Emissione luminosa solo indiretta  
Indirect light emission only
- Emissione luminosa solo diretta  
Direct light emission only
- Apparecchio con possibilità di installazione a plafone  
Fixture suitable for ceiling
- Apparecchio da parete  
Wall fixture
- Apparecchio con possibilità di installazione a parete e plafone  
Fixture suitable for ceiling and wall fixing

# SISTEMA DI CODIFICA / CODE SYSTEM

Tipologia di installazione	Legenda	Finiture diffusori	Legenda	K/Ra /°	Legenda	Elettrificazione	Legenda
Type of mounting	Legend	Colour finish diffuser	Legend	K/Ra /°	Legend	Electricity	Legend
<b>A</b>	parete / wall	<b>00</b>	nessuna / unfinished	<b>00</b>		<b>00</b>	standard
<b>B</b>	attacco a binario / electrical adapter	<b>01</b>	bianco / white	<b>01</b>	3000K/80	<b>01</b>	alimentazione standard standard power supply
<b>C</b>	tavolo / table	<b>02</b>	nero / black	<b>02</b>	2700K/80		
<b>CA</b>	parete-mensola / wall bracket	<b>05</b>	champagne / champagne	<b>03</b>	4000K/80	<b>02</b>	alimentazione DALI / PUSH DIM DALI / PUSH DIM power supply
<b>CM</b>	tavolo morsetto / table clamp	<b>06</b>	nero satinato / mat black	<b>04</b>	3000K/90		
<b>CP</b>	tavolo perno / table bolt down	<b>07</b>	avorio / ivory	<b>05</b>	2700K/90	<b>03</b>	alimentazione 1-10V / Push DIM 1-10V / PUSH DIM power supply
<b>EA</b>	esterno parete / exterior wall	<b>16</b>	corten / corten	<b>06</b>	4000K/90		
<b>EC</b>	esterno tavolo / exterior table	<b>17</b>	bronzo / bronze	<b>11</b>	2700K/80/NS	<b>04</b>	taglio di fase / phase cut
<b>EL</b>	esterno sospensione exterior suspension	<b>19</b>	ottone satinato / mat brass	<b>12</b>	2700K/80/S	<b>05</b>	RGB
		<b>21</b>	foglia oro / gold leaf	<b>13</b>	2700K/80/FL	<b>06</b>	LED tensione di rete / 220V LED
<b>EP</b>	esterno soffitto / exterior ceiling	<b>22</b>	cromo / chrome	<b>14</b>	2700K/80/WFL	<b>07</b>	emergenza / emergency
<b>ET</b>	esterno terra / exterior floor	<b>23</b>	foglia argento / silver leaf	<b>15</b>	2700K/90/NS	<b>08</b>	mono standard
<b>L</b>	sospensione / suspension	<b>24</b>	foglia rame / copper leaf	<b>16</b>	2700K/90/S	<b>09</b>	Step DIM
		<b>27</b>	verde oliva materico / textured olive green	<b>17</b>	2700K/90/FL	<b>10</b>	24V
<b>M</b>	sospensione senza rosone suspension without canopy	<b>28</b>	bianco soft materico / textured soft white	<b>18</b>	2700K/90/WFL	<b>11</b>	12V
		<b>29</b>	terracotta naturale materico / textured natural terracotta	<b>19</b>	3000K/80/NS	<b>12</b>	alimentazione a due livelli bilevel driver
<b>PE</b>	esterno terra picchetto exterior floor peg	<b>30</b>	titanio / titanium	<b>20</b>	3000K/80/S		
		<b>34</b>	grigio micaceo / micaceous grey	<b>21</b>	3000K/80/FL	<b>14</b>	batteria / battery
<b>T</b>	terra / floor	<b>40</b>	titanio-diffusore fumé / titanium-smoky grey diffuser	<b>22</b>	3000K/80/WFL	<b>15</b>	corrente costante / constant current
<b>X</b>	incasso / recessed downlight	<b>41</b>	titanio-diffusore bianco / titanium-white diffuser	<b>23</b>	3000K/90/NS	<b>16</b>	48V
		<b>42</b>	gesso / plaster	<b>24</b>	3000K/90/S	<b>17</b>	bianco dinamico/tunable white
<b>XG</b>	sistema da incasso recessed linear system	<b>43</b>	titanio - diffusore verde foresta / titanium - forest green diffuser	<b>25</b>	3000K/90/FL	<b>18</b>	24V DALI/Push DIM + corrente costante standard DALI/Push DIM 24V + standard constant current
		<b>44</b>	marrone metallizzato / metallized brown	<b>26</b>	3000K/90/WFL		
<b>XGQ</b>	invisibile senza cornice quadrato recessed trimless squared	<b>45</b>	legno-ottone satinato / wood-mat brass	<b>27</b>	4000K/90/NS	<b>19</b>	48V DALI
		<b>46</b>	bianco-policarbonato opale / white-opal polycarbonate	<b>28</b>	4000K/90/S		
<b>XGR</b>	invisibile senza cornice tondo recessed trimless round	<b>47</b>	bianco-policarbonato prismatico / white-micropismatic polycarbonate	<b>29</b>	4000K/90/FL	<b>20</b>	DALI
		<b>48</b>	nero-policarbonato opale / black-opal polycarbonate	<b>30</b>	4000K/90/WFL		
<b>XM</b>	accessorio / accessory	<b>49</b>	nero-policarbonato prismatico / black-micropismatic polycarbonate	<b>31</b>	3000K, CRI>85	<b>21</b>	DIM-to-warm + bianco dinamico DIM-to-warm + tunable white
		<b>51</b>	nero-diffusore bianco / black-white diffuser	<b>32</b>	2700K, CRI>85		
<b>Y</b>	accessorio / accessory	<b>52</b>	nero-diffusore cristallo / black-crystal diffuser	<b>33</b>	4000K, CRI>85	<b>22</b>	dimmer su cavo / dimmer on cable
		<b>53</b>	nero-diffusore acciaio / black-steel diffuser	<b>34</b>	2700K, CRI>85, NS	<b>23</b>	wireless ZigBee
		<b>54</b>	nero-diffusore ambra / black-amber diffuser	<b>35</b>	2700K, CRI>85, S	<b>24</b>	24V + corrente costante 24V + constant current
		<b>55</b>	nero-diffusore bronzo / black-bronze diffuser	<b>36</b>	2700K, CRI>85, FL		
		<b>56</b>	nero-diffusore tabacco / black-tobacco diffuser	<b>37</b>	2700K, CRI>85, WFL	<b>25</b>	Wireless Casambi
		<b>57</b>	nero-diffusore verde / black-green diffuser	<b>38</b>	3000K, CRI>85, NS	<b>26</b>	PWM - 0/1-10V
		<b>71</b>	ottone satinato-diffusore bianco / mat brass-white diffuser	<b>39</b>	3000K, CRI>85, S	<b>27</b>	dimmerabile / dimmable
		<b>72</b>	ottone satinato-diffusore cristallo / mat brass-crystal diffuser	<b>40</b>	3000K, CRI>85, FL	<b>99</b>	no elettrificazione / no electricity
		<b>73</b>	ottone satinato-diffusore acciaio / mat brass-steel diffuser	<b>41</b>	3000K, CRI>85, WFL		
		<b>74</b>	ottone satinato-diffusore ambra / mat brass-amber diffuser	<b>42</b>	4000K, CRI>85, NS		
		<b>75</b>	ottone satinato-diffusore bronzo / mat brass-bronze diffuser	<b>43</b>	4000K, CRI>85, S		
		<b>76</b>	ottone satinato-diffusore tabacco / mat brass-tobacco diffuser	<b>44</b>	4000K, CRI>85, FL		
		<b>77</b>	ottone satinato-diffusore verde / mat brass-green diffuser	<b>45</b>	4000K, CRI>85, WFL		
		<b>80</b>	nero satinato-oro / mat black-gold	<b>90</b>	2700-6500K/90		
		<b>81</b>	bianco-oro / white-gold	<b>91</b>	2200-4000K/90		
<b>83</b>	legno / wood						

Descrizione fascio Light beam description	Legenda Legend	Gradi Degrees
Fascio strettissimo Narrow	<b>NS</b>	< 12°
Fascio stretto Spot	<b>S</b>	13° ->21°
Fascio medio Flood	<b>FL</b>	22° ->40°
Fascio largo Wide flood	<b>WFL</b>	41° ->60°
Fascio diffuso Diffused	<b>Nessuna sigla No code</b>	> 60°

# INDEX

Page	Code	Collection	Page	Code	Collection
70	015	Smoke	146	9005	Astoria In
47	019	Gonio	148	9005	Astoria Out
81	020 - 021	Viisi	145	B430	Astoria Spot
15	022	AlDecimo	144	B431	Astoria Line
72	025 - 026 - 027	To-Be	142	B432	Astoria 5
48	028 - 029	Hilow	143	B433	Astoria 3
91	031	Zero Ellipse	141	B434	Astoria 8
92	032	Zero Square	161	B470	Soho Line
85	033	Zero Round Smart	160	B700	Soho S 15
87	033	Zero Round	159	B752	Soho 5
90	034	Zero Round Vertical	158	B753	Soho 10
84	036	Zero Line	157	B754	Soho 20
71	039	Three	153	B760	Queens 20
106	045	Zero Round Acoustic	151	B770	Queens 45
104	046	Arena Acoustic	119	KG233	Brooklyn
111	047	Ralph	121	KG234	Brooklyn Trim
114	048	Venexia	123	KP233	Brooklyn Out
34	049	Cross	117	KG247	Bronx
19	052 - 053	Bella	183	X168	Taylor
106	055	Zero Round Acoustic	186	X335	Jersey
104	056	Arena Acoustic	184	XA2115	Joe
105	058	Phi	184	XA2116	Joe
33	064	Carmen	138	XG249	Tribeca
40	065	Gilbert	130	XG251	Harlem
65	068	Opuntia	132	XG270	Kips
83	072	Ypsilon	131	XG271-XG272-XG273	Kips Round
78	073	Tubino	133	XG2044	Manhattan
80	073	Tubino Plus	125	XG2045	Corner
17	074	Arena	168	XGQ0998	East
82	076	Willy Glass	169	XGQ0998GL	East
52	077	Jackie	169	XGQ1004	East
37-109	078	Firefly in the sky	169	XGQ1004-GL	East
42	081	Golden Ring	172	XGQ1025	Step by Step
44	082	Silver Ring	172	XGQ1026	Step by Step
35-108	084 - 085 - 086	Dip	173	XGQ1210	Moai
63	091	Emma	168	XGR0997	East
41	092	Ginevra	170	XGR1021	East
46	093	Gong	171	XGR1023	Step by Step
64	094	Clio	171	XGR1024	Step by Step
30	095	Candle	167	XGR1212	Click Clack
62	097	Olivia	155	XM75 - XM76	Queens
16	098	App	164	XM445	Soho Out
87	103	Zero Round	162	XM446	Soho In
50	107-108-109-110	Hilow Line	154	XM748	Queens 10
68	112	Roris	152	XM751	Queens 25
56	115-117-118-119	Murané	127	XP246	Giano
59	106-116	Murané R	136	XP248	Broadway
55	120	Lola	137	XP250	Nook
31	122-123	Carl	176	XR130 - 131	Jarvis
32	125	Carl2	178	XR225	Nick
12	127	432 Ways	182	XR170	Sid
54	135 - 136	Jay	174	XR172	Eddie
22	138	Bow	177	XR174	Jessie
76	141	Toy S	175	XR177	James
74	142	Toy R	180	XR178	Rally Trim
66-113	148	Roma	178	XR254	Nick
27	231 - 232	Brooklyn Round	179	XR262	Nick
26	233	Brooklyn Line	93		Offset and Canopies
38	246	Giano			

## INTERNO / INDOOR

12	432 WAYS
15	ALDECIMO
16	APP
17	ARENA
19	BELLA
22	BOW
26	BROOKLYN LINE
27	BROOKLYN ROUND
28	BROOKLYN ROUND CANOPIES
30	CANDLE
31	CARL
32	CARL2
33	CARMEN
64	CLIO
34	CROSS
35	DIP
63	EMMA
37	FIREFLY in the sky
38	GIANO
40	GILBERT
41	GINEVRA
42	GOLDEN RING
46	GONG
47	GONIO
48	HILOW
50	HILOW LINE
52	JACKIE

54	JAY
55	LOLA
56	MURANÈ
59	MURANÈ R
62	OLIVIA
65	OPUNTIA
66	ROMA
68	RORIS
44	SILVER RING
70	SMOKE
71	THREE
72	TO-BE
74	TOY R
76	TOY S
78	TUBINO
80	TUBINO PLUS
81	VIISI
82	WILLY GLASS
83	YPSILON
91	ZERO ELLIPSE
84	ZERO LINE
87	ZERO ROUND
85	ZERO ROUND SMART
90	ZERO ROUND VERTICAL
92	ZERO SQUARE
94	ZERO SHAPES CANOPIES



# 432 WAYS

Officina Panzeri 2024



Apparecchio di illuminazione da soffitto ad emissione diretta disponibile in 3 dimensioni, con supporto lente con ottica arretrata e lente emisferica anti-abbagliamento. Sono 432 le diverse possibili combinazioni che il prodotto consente di creare, permettendo di scegliere, oltre che le dimensioni e l'elettrificazione, anche gli accoppiamenti di finitura tra corpo del faretto e supporto lente. Disponibili le finiture bianco, nero, bronzo, ottone satinato, verde oliva materico e terracotta naturale materico, che rendono questo spotlight uno strumento di personalizzazione degli spazi in cui è inserito.

Direct-emission ceiling fixture available in 3 sizes, with lens holder with recessed optics and anti-glare hemispherical lens. There are 432 different possible combinations that the product allows to create, permitting the choice not only of dimensions and electrification, but also of finish couplings between the spotlight body and lens holder. White, black, bronze, mat brass, textured olive green and natural textured terracotta finishes are available, making this spotlight a customisation tool for the spaces in which it is placed.

NEW

CODICE CODE	FONTI LUMINOSE LIGHT SOURCES	kg
-------------	------------------------------	----

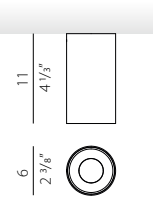

<b>P12701.006.0501</b>	Potenza assorbita apparecchio / Luminaire power consumption 6,7W
<b>P12702.006.0501</b>	Flusso luminoso apparecchio / Luminaire luminous flux 740lm
<b>P12717.006.0501</b>	2700K Ra>90 220-240V AC ON-OFF
<b>P12719.006.0501</b>	IP40
<b>P12727.006.0501</b>	
<b>P12729.006.0501</b>	

<b>P12701.006.0401</b>	Potenza assorbita apparecchio / Luminaire power consumption 6,7W
<b>P12702.006.0401</b>	Flusso luminoso apparecchio / Luminaire luminous flux 760lm
<b>P12717.006.0401</b>	3000K Ra>90 220-240V AC ON-OFF
<b>P12719.006.0401</b>	IP40
<b>P12727.006.0401</b>	
<b>P12729.006.0401</b>	

<b>P12701.006.0502</b>	Potenza assorbita apparecchio / Luminaire power consumption 6,7W
<b>P12702.006.0502</b>	Flusso luminoso apparecchio / Luminaire luminous flux 740lm
<b>P12717.006.0502</b>	2700K Ra>90 220-240V AC dimmable (DALI/Push DIM)
<b>P12719.006.0502</b>	IP40
<b>P12727.006.0502</b>	
<b>P12729.006.0502</b>	

<b>P12701.006.0402</b>	Potenza assorbita apparecchio / Luminaire power consumption 6,7W
<b>P12702.006.0402</b>	Flusso luminoso apparecchio / Luminaire luminous flux 760lm
<b>P12717.006.0402</b>	3000K Ra>90 220-240V AC dimmable (DALI/Push DIM)
<b>P12719.006.0402</b>	IP40
<b>P12727.006.0402</b>	
<b>P12729.006.0402</b>	

Supporto lente obbligatorio non incluso, da acquistare separatamente. Mandatory lens holder not included, to be purchased separately.

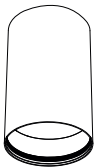





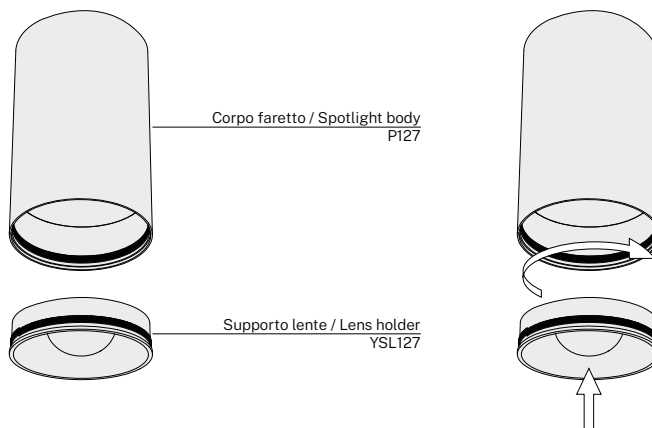



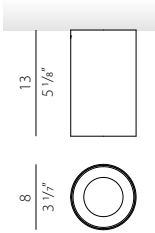

<b>YSL12701.006.FL</b>	Supporto lente per 432 Ways, in alluminio, con verniciatura poliaccrilica in colore bianco, nero, bronzo, ottone satinato, verde oliva materico o terracotta naturale materico.
<b>YSL12702.006.FL</b>	
<b>YSL12717.006.FL</b>	
<b>YSL12719.006.FL</b>	
<b>YSL12727.006.FL</b>	
<b>YSL12729.006.FL</b>	

**432 WAYS È COSTITUITO DA DUE PARTI, DA ACQUISTARE SEPARATAMENTE**  
**432 WAYS CONSISTS OF TWO PARTS, TO BE ORDERED SEPARATELY**



# 432 WAYS





Officina Panzeri 2024

	CODICE CODE	FONTI LUMINOSE LIGHT SOURCES	kg
	 <b>P12701.008.0504</b> <b>P12702.008.0504</b> <b>P12717.008.0504</b> <b>P12719.008.0504</b> <b>P12727.008.0504</b> <b>P12729.008.0504</b>	Potenza assorbita apparecchio / Luminaire power consumption 10,7W Flusso luminoso apparecchio / Luminaire luminous flux 1145lm 2700K Ra>90 220-240V AC dimmable (phase cut)  <b>IP40</b>	
	 <b>P12701.008.0404</b> <b>P12702.008.0404</b> <b>P12717.008.0404</b> <b>P12719.008.0404</b> <b>P12727.008.0404</b> <b>P12729.008.0404</b>	Potenza assorbita apparecchio / Luminaire power consumption 10,7W Flusso luminoso apparecchio / Luminaire luminous flux 1169lm 3000K Ra>90 220-240V AC dimmable (phase cut)  <b>IP40</b>	
	 <b>P12701.008.0502</b> <b>P12702.008.0502</b> <b>P12717.008.0502</b> <b>P12719.008.0502</b> <b>P12727.008.0502</b> <b>P12729.008.0502</b>	Potenza assorbita apparecchio / Luminaire power consumption 10,7W Flusso luminoso apparecchio / Luminaire luminous flux 1145lm 2700K Ra>90 220-240V AC dimmable (DALI/Push DIM)  <b>IP40</b>	
	 <b>P12701.008.0402</b> <b>P12702.008.0402</b> <b>P12717.008.0402</b> <b>P12719.008.0402</b> <b>P12727.008.0402</b> <b>P12729.008.0402</b>	Potenza assorbita apparecchio / Luminaire power consumption 10,7W Flusso luminoso apparecchio / Luminaire luminous flux 1169lm 3000K Ra>90 220-240V AC dimmable (DALI/Push DIM)  <b>IP40</b>	
	 <b>YSL12701.008.FL</b> <b>YSL12702.008.FL</b> <b>YSL12717.008.FL</b> <b>YSL12719.008.FL</b> <b>YSL12727.008.FL</b> <b>YSL12729.008.FL</b>	Supporto lente per 432 Ways, in alluminio, con verniciatura poliaccrilica in colore bianco, nero, bronzo, ottone satinato, verde oliva materico o terracotta naturale materico. Lens holder for 432 Ways, in aluminium, with polyacrylic paint finish in white, black, bronze, mat brass, textured olive green or textured natural terracotta.	

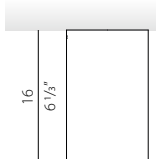

# 432 WAYS

Officina Panzeri 2024

	CODICE CODE	FONTI LUMINOSE LIGHT SOURCES	kg
	 <b>P12701.010.0504</b> <b>P12702.010.0504</b> <b>P12717.010.0504</b> <b>P12719.010.0504</b> <b>P12727.010.0504</b> <b>P12729.010.0504</b>	Potenza assorbita apparecchio / Luminaire power consumption 16,4W Flusso luminoso apparecchio / Luminaire luminous flux 1756lm 2700K Ra>90 220-240V AC dimmable (phase cut)	
	 <b>P12701.010.0404</b> <b>P12702.010.0404</b> <b>P12717.010.0404</b> <b>P12719.010.0404</b> <b>P12727.010.0404</b> <b>P12729.010.0404</b>	Potenza assorbita apparecchio / Luminaire power consumption 16,4W Flusso luminoso apparecchio / Luminaire luminous flux 1792lm 3000K Ra>90 220-240V AC dimmable (phase cut)	
	 <b>P12701.010.0502</b> <b>P12702.010.0502</b> <b>P12717.010.0502</b> <b>P12719.010.0502</b> <b>P12727.010.0502</b> <b>P12729.010.0502</b>	Potenza assorbita apparecchio / Luminaire power consumption 16,4W Flusso luminoso apparecchio / Luminaire luminous flux 1756lm 2700K Ra>90 220-240V AC dimmable (DALI/Push DIM)	
	 <b>P12701.010.0402</b> <b>P12702.010.0402</b> <b>P12717.010.0402</b> <b>P12719.010.0402</b> <b>P12727.010.0402</b> <b>P12729.010.0402</b>	Potenza assorbita apparecchio / Luminaire power consumption 16,4W Flusso luminoso apparecchio / Luminaire luminous flux 1792lm 3000K Ra>90 220-240V AC dimmable (DALI/Push DIM)	
	<b>YSL12701.010.FL</b> <b>YSL12702.010.FL</b> <b>YSL12717.010.FL</b> <b>YSL12719.010.FL</b> <b>YSL12727.010.FL</b> <b>YSL12729.010.FL</b>	Supporto lente per 432 Ways, in alluminio, con verniciatura poliaccrilica in colore bianco, nero, bronzo, ottone satinato, verde oliva materico o terracotta naturale materico. Lens holder for 432 Ways, in aluminium, with polyacrylic paint finish in white, black, bronze, mat brass, textured olive green or textured natural terracotta.	

**Supporto lente obbligatorio non incluso, da acquistare separatamente. Mandatory lens holder not included, to be purchased separately.**

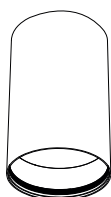

Fotometrie disponibili [www.panzeri.it](http://www.panzeri.it) / Photometric data available at [www.panzeri.it](http://www.panzeri.it)

## CODICI COLORI DISPONIBILI / COLOUR CODES AVAILABLE

**01** bianco white     
 **02** nero black     
 **17** bronzo bronze     
 **19** ottone satinato mat brass     
 **27** verde oliva materico textured olive green     
 **29** terracotta naturale materico textured natural terracotta







# ALDECIMO



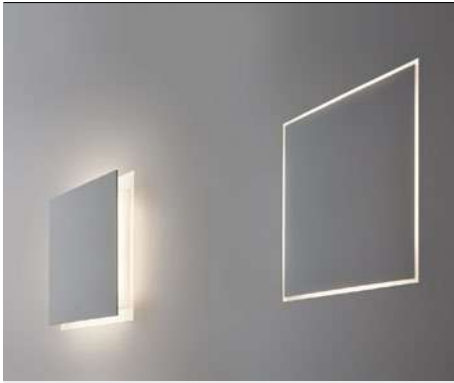

Carmen Ferrara 2017

Registered Design

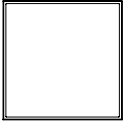
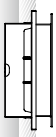

Lampada ad incasso da parete a scomparsa in metallo con meccanismo di apertura e chiusura a pressione. Sorgente luminosa composta da modulo LED a luce indiretta e driver bi-level integrato nell'apparecchio per diminuire il consumo e il flusso luminoso in modalità di chiusura, per ottenere un perimetro luminoso. Finitura in vernice poliaccrilica bianca. Ideale per camere da letto, living e per creare composizioni d'effetto su grandi pareti.

Wall-mount metal recessed trimless lamp with opening and closing click mechanism. Light source made of LED module with indirect light and integrated bi-level driver to reduce luminous flux and power consumption, creating a luminous perimetral frame, when closed. Finish in white polyacrylic paint. Ideal for bedrooms, living areas and to create composition on wide walls.

CODICE CODE		FONTI LUMINOSE LIGHT SOURCES	kg
 <b>X02201.030.0412</b>		Potenza assorbita apparecchio / Luminaire power consumption 21W Flusso luminoso apparecchio / Luminaire luminous flux 873lm 3000K Ra>90 220-240V AC bilevel dimming  IP20	1,28
 29,4 11 3/8"	 7,7 4 3" 1 1/2"	 29,5x29,5 11 3/8" x 11 3/8"	



Fotometrie disponibili [www.panzeri.it](http://www.panzeri.it) / Photometric data available at [www.panzeri.it](http://www.panzeri.it)

CODICI COLORI DISPONIBILI / COLOUR CODES AVAILABLE

01 bianco  
white



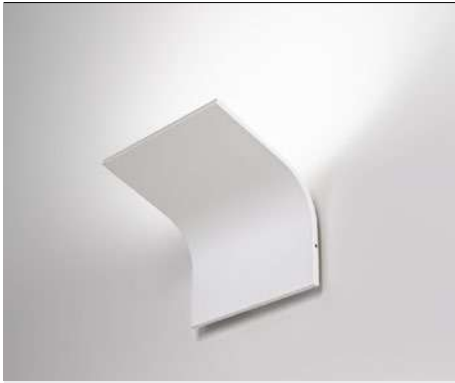

Lampada da parete in profilato di alluminio estruso. Sorgente luminosa composta da 1 modulo LED o 2 moduli LED a tensione di rete (220V). Modulo LED equipaggiato con speciale protezione da sovratensioni e coperchio di protezione trasparente. Dimmerazione possibile attraverso apposito variatore di luce (non incluso). Finitura con vernice poliaccrilica bianca, ottone satinato o spazzolato e verniciato color titanio. Fissaggio con grani laterali a scomparsa. Ideale per corridoi o uso residenziale.

Wall lamp in extruded aluminium. Lighting source made of 1 LED module or 2 LED modules to mains voltage (220V). LED module equipped with special protection from power surges and transparent cover. Possible dimming with specific dimmer (not included) – available as accessory. White or mat brass polyacrylic paint or brushed and painted in titanium colour. Fixing with hidden lateral grub screw. Ideal for corridors or residential use.

CODICE CODE	FONTI LUMINOSE LIGHT SOURCES	kg
-------------	------------------------------	----

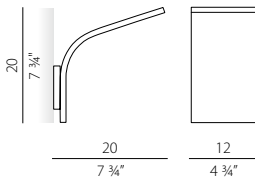

**A09801.001.0406**  
**A09819.001.0406**  
**A09830.001.0406**

Potenza assorbita apparecchio / Luminaire power consumption 18W  
Flusso luminoso apparecchio / Luminaire luminous flux 1431lm  
3000K Ra>90 220-240V AC ON-OFF  
 IP20

1,00

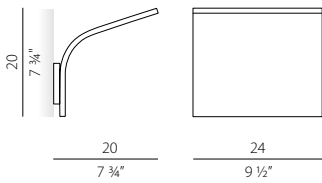

**A09801.002.0406**  
**A09819.002.0406**  
**A09830.002.0406**

Potenza assorbita apparecchio / Luminaire power consumption 36W  
Flusso luminoso apparecchio / Luminaire luminous flux 2862lm  
3000K Ra>90 220-240V AC ON-OFF  
 IP20

2,03

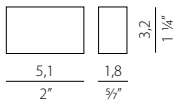
**XM14/230**

Dispositivo dimmerabile per moduli LED a 230V, 5÷100W.  
Dimmable device for 230V LED modules, 5÷100W.

Fotometrie disponibili [www.panzeri.it](http://www.panzeri.it) / Photometric data available at [www.panzeri.it](http://www.panzeri.it)

CODICI COLORI DISPONIBILI / COLOUR CODES AVAILABLE

Disponibili a richiesta LED 2700K / On request 2700K LED available

**01** bianco  
white

**19** ottone satinato  
mat brass

**30** titanio  
titanium







Lampada a sospensione in alluminio estruso curvato con schermo in policarbonato opale e spot orientabili. Linea interna luminosa e spot dimmerabili in tutte le versioni con tecnologia DALI/Push DIM. Finitura in vernice poliaccrilica color bianco, nero, titanio, bronzo e ottone satinato. Possibili colori custom su richiesta. Ideale per hall, zone living, retail e grandi spazi.

Suspension lamp in extruded curved aluminium with opal polycarbonate screen and adjustable spots. Dimmable interior light line and spots on all versions with DALI/Push DIM technology. White, black, titanium, bronze and mat brass finishes are available. Custom colors are available on request. Ideal for halls, living areas, retail and large spaces.

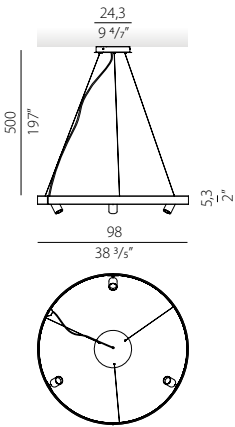
NEW	CODICE CODE	FONTI LUMINOSE LIGHT SOURCES	kg
-----	-------------	------------------------------	----



-  **L07401.100.0502**
- L07402.100.0502**
- L07417.100.0502**
- L07419.100.0502**
- L07430.100.0502**

Potenza assorbita apparecchio / Luminaire power consumption 92W  
 Flusso luminoso apparecchio / Luminaire luminous flux 6732lm  
 2700K Ra>90 30° 220-240V AC dimmable (DALI/Push DIM)

 **IP20**

Fornito con n.3 M79D per eventuale decentramento del rosone  
 Supplied with n.3 M79D for possible reposition of canopy

4,82

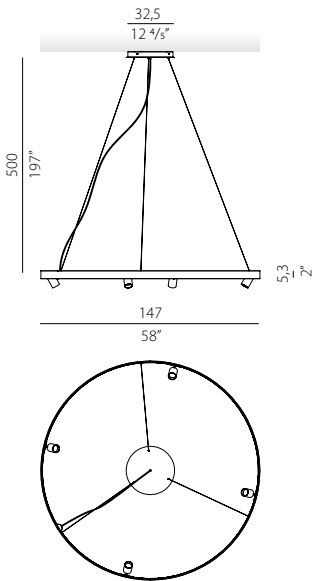

-  **L07401.150.0502**
- L07402.150.0502**
- L07417.150.0502**
- L07419.150.0502**
- L07430.150.0502**

Potenza assorbita apparecchio / Luminaire power consumption 129W  
 Flusso luminoso apparecchio / Luminaire luminous flux 9675lm  
 2700K Ra>90 30° 220-240V AC dimmable (DALI/Push DIM)

 **IP20**

Fornito con n.3 M79D per eventuale decentramento del rosone  
 Supplied with n.3 M79D for possible reposition of canopy

7,52

# ARENA

Enzo Panzeri 2020

	CODICE CODE	FONTI LUMINOSE LIGHT SOURCES	kg
	<b>L07401.200.0502</b>	Potenza assorbita apparecchio / Luminaire power consumption 154W	8,80
	<b>L07402.200.0502</b>	Flusso luminoso apparecchio / Luminaire luminous flux 12618lm	
	<b>L07417.200.0502</b>	2700K Ra>90 30° 220-240V AC dimmable (DALI/Push DIM)	
	<b>L07419.200.0502</b>	<b>IP20</b>	
	<b>L07430.200.0502</b>	Fornito con n.4 M79D per eventuale decentramento del rosone Supplied with n.4 M79D for possible reposition of canopy	

Fotometrie disponibili [www.panzeri.it](http://www.panzeri.it) / Photometric data available at [www.panzeri.it](http://www.panzeri.it)

CODICI COLORI DISPONIBILI / COLOUR CODES AVAILABLE

Disponibili a richiesta LED 3000K / On request 3000K LED available

**01** bianco white      **02** nero black      **17** bronzo bronze      **19** ottone satinato mat brass      **30** titanio titanium





Lampada da sospensione, tavolo e parete (disponibile anche a incasso) con testa in pressofusione di alluminio. Diffusore in materiale acrilico con perimetro luminoso. Braccio conico decentrato, testa orientabile e comando Step DIM a 5 regolazioni di intensità luminosa caratterizzano le versioni da tavolo e parete, quest'ultima con snodo anche alla base, per una maggiore flessibilità nel posizionamento. La versione a sospensione, testa fissa e con tige centrale è disponibile in versione a emissione diretta e indiretta. Disponibile paralume in tessuto color avorio "Bella vestita" disegnato da Matteo Thun, da ordinare separatamente. Bianco, nero, titanio, bronzo e ottone satinato le finiture disponibili.

Suspension, table and wall lamp (also available recessed) with die-cast aluminium head. Diffuser in acrylic material with luminous perimeter. Decentralized conical arm, adjustable head and technology Step DIM with 5 intensity of light settings characterize the table and wall versions, the latter also with a joint at the base, for a higher positioning flexibility. The suspension version has a fixed head with central tige, is available in direct and indirect light versions. Ivory fabric lampshade "Bella vestita" designed by mateo Thun is available, to order separately. White, black, titanium, bronze and mat brass finishes are available.

	CODICE CODE	FONTE LUMINOSA LIGHT SOURCES	kg
	<b>L05201.011.0501</b>	Potenza assorbita apparecchio / Luminaire power consumption 6,5W	0,55
	<b>L05202.011.0501</b>	Flusso luminoso apparecchio / Luminaire luminous flux 388lm	
	<b>L05217.011.0501</b>	2700K Ra>90 220-240V AC ON-OFF	
	<b>L05219.011.0501</b>	IP40	
	<b>L05230.011.0501</b>		
	<b>L05301.011.0501</b>	Potenza assorbita apparecchio / Luminaire power consumption 6,5W	0,55
	<b>L05302.011.0501</b>	Flusso luminoso apparecchio / Luminaire luminous flux 388lm	
	<b>L05317.011.0501</b>	2700K Ra>90 220-240V AC ON-OFF	
	<b>L05319.011.0501</b>	IP40	
	<b>L05330.011.0501</b>		
	<b>M05201.011.0510</b>	Potenza assorbita apparecchio / Luminaire power consumption 4,5W	0,22
	<b>M05202.011.0510</b>	Flusso luminoso apparecchio / Luminaire luminous flux 388lm	
	<b>M05217.011.0510</b>	2700K Ra>90 24V DC	
	<b>M05219.011.0510</b>	IP40	
	<b>M05230.011.0510</b>	Fornito senza rosone e driver, per composizioni multiple Supplied without canopy and driver, for multiple configurations	
	<b>M05301.011.0510</b>	Potenza assorbita apparecchio / Luminaire power consumption 4,5W	0,22
	<b>M05302.011.0510</b>	Flusso luminoso apparecchio / Luminaire luminous flux 388lm	
	<b>M05317.011.0510</b>	2700K Ra>90 24V DC	
	<b>M05319.011.0510</b>	IP40	
	<b>M05330.011.0510</b>	Fornito senza rosone e driver, per composizioni multiple Supplied without canopy and driver, for multiple configurations	

# BELLA

Enzo Panzeri 2019/2020



Registered Design

CODICE

FONTI LUMINOSE  
LIGHT SOURCES

kg

**C05201.011.0509**  
**C05202.011.0509**  
**C05217.011.0509**  
**C05219.011.0509**  
**C05230.011.0509**

Potenza assorbita apparecchio / Luminaire power consumption 5W  
Flusso luminoso apparecchio / Luminaire luminous flux 388lm  
2700K Ra>90 220-240V AC dimmable (Step DIM)  
 **IP20**   
Interruttore incluso  
Switch included

0,88

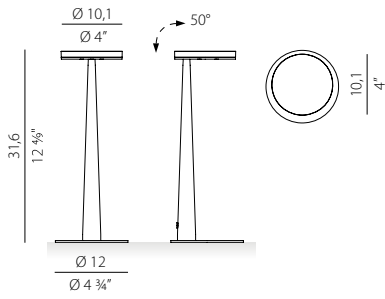

**A05201.011.0509**  
**A05202.011.0509**  
**A05217.011.0509**  
**A05219.011.0509**  
**A05230.011.0509**

Potenza assorbita apparecchio / Luminaire power consumption 5W  
Flusso luminoso apparecchio / Luminaire luminous flux 388lm  
2700K Ra>90 220-240V AC dimmable (Step DIM)  
 **IP20**  
Interruttore incluso  
Switch included

0,56

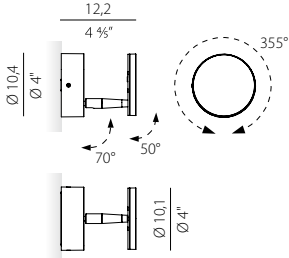

**X05201.011.0509**  
**X05202.011.0509**  
**X05217.011.0509**  
**X05219.011.0509**  
**X05230.011.0509**

Potenza assorbita apparecchio / Luminaire power consumption 5W  
Flusso luminoso apparecchio / Luminaire luminous flux 388lm  
2700K Ra>90 220-240V AC dimmable (Step DIM)  
 **IP20**  
Interruttore incluso  
Switch included

0,93

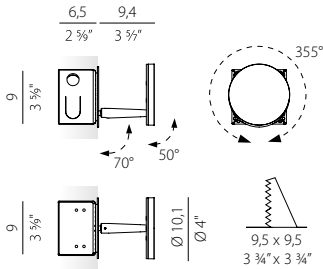

red dot winner 2020

Fotometrie disponibili [www.panzeri.it](http://www.panzeri.it) / Photometric data available at [www.panzeri.it](http://www.panzeri.it)

## CODICI COLORI DISPONIBILI / COLOUR CODES AVAILABLE

**01** bianco white      **02** nero black      **17** bronzo bronze      **19** ottone satinato mat brass      **30** titanio titanium





# BELLA VESTITA

Matteo Thun 2020



Paralume in tessuto plissé, accessorio per Bella a sospensione con emissione diretta.

Pleated fabric lampshade, accessory for suspended Bella with direct light.

	CODICE CODE	FONTI LUMINOSE LIGHT SOURCES	kg
	<b>YPL05207.015</b>	Paralume in tessuto plissé colore avorio, semplice installazione a scatto. Ivory pleated fabric lampshade, simple snap installation.	0,08

Fotometrie disponibili [www.panzeri.it](http://www.panzeri.it) / Photometric data available at [www.panzeri.it](http://www.panzeri.it)

CODICI COLORI DISPONIBILI / COLOUR CODES AVAILABLE





**07** avorio  
ivory



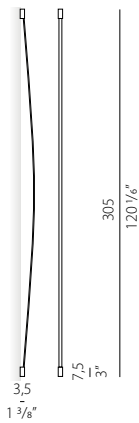

Bow è l'espressione della flessibilità, una sottile linea che si curva sulle pareti per creare nuove geometrie attraverso la forma e la luce. Il corpo in policarbonato estruso si presta per accogliere segmenti di luce che possono essere posizionati a piacimento lungo tutta la sua estensione, creando linee luminose continue oppure tratti alternati. Questa versatilità permette di poter giocare con l'architettura disegnando linee rette, curve, zone luminose e zone buie. Bow può essere accorciato a piacimento e installato sia singolarmente che in configurazioni lineari composte da più moduli. Disponibile nelle finiture bianco, nero e legno. Una serie di accessori completa la famiglia per permettere di personalizzare l'installazione e l'illuminazione.

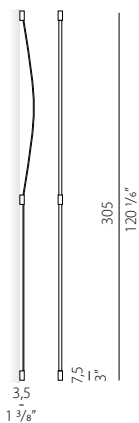
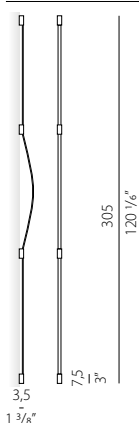
Bow is the expression of flexibility, a thin line that curves around the walls to create new geometries through shape and light. The extruded polycarbonate body lends itself to accommodate segments of light that can be positioned at will along its entire extension, creating continuous light lines or alternating strokes. This versatility makes it possible to play with the architecture by drawing straight lines, curves, bright zones and dark zones. Bow could be cut and installed either singly or in linear configurations composed of several modules. Available in white, black and wood finishes. A series of accessories completes the family to allow customised installation and lighting.



	CODICE CODE	FONTI LUMINOSE LIGHT SOURCES	kg
	<b>A13806.302.0010</b> <b>A13883.302.0010</b>	Profilo elettrificato flessibile. Alimentazione 24V DC. Flexible electrified profile. Power supply 24V DC.  <b>IP20</b>  Completo di n.2 box di fissaggio e kit di alimentazione. LED e driver non inclusi. Complete with 2 fixing boxes and power supply kit. LED and driver not included.	0,48
	<b>A13806.303.0010</b> <b>A13883.303.0010</b>	Profilo elettrificato flessibile. Alimentazione 24V DC. Flexible electrified profile. Power supply 24V DC.  <b>IP20</b>  Completo di n.3 box di fissaggio e kit di alimentazione. LED e driver non inclusi. Complete with 3 fixing boxes and power supply kit. LED and driver not included.	0,62
	<b>A13806.304.0010</b> <b>A13883.304.0010</b>	Profilo elettrificato flessibile. Alimentazione 24V DC. Flexible electrified profile. Power supply 24V DC.  <b>IP20</b>  Completo di n.4 box di fissaggio e kit di alimentazione. LED e driver non inclusi. Complete with 4 fixing boxes and power supply kit. LED and driver not included.	0,72



# BOW

Maurizio Quargnale 2023

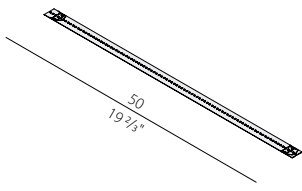
Registered Design

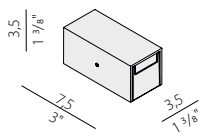
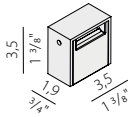
	CODICE CODE	FONTI LUMINOSE LIGHT SOURCES	kg
	<b>YLB138.050.0510</b>	Modulo LED, 500mm (19,7") 98 LED 8W 24V DC 2700K Ra>90 800lm. LED module, 500mm (19,7") 98 LED 8W 24V DC 2700K Ra>90 800lm.   Completo di n.2 molle di fissaggio. Complete with no. 2 fixing springs.	0,01
	<b>YBF13806.007</b> <b>YBF13883.007</b>	Box di fissaggio in alluminio pressofuso con cover di chiusura in alluminio estruso per profilo Bow, con finitura in colore nero satinato o legno. Die-cast aluminium fastening box with extruded aluminium end cover for Bow profile, in mat black or wood finish.	0,12
<b>NEW</b> 	<b>YFL13806.002</b> <b>YFL13883.002</b>	Distanziale per tratti lineari illuminati Bow, in alluminio, in finitura colore nero satinato e legno. Spacer for illuminated linear sections for Bow, made of aluminium, with mat black and wood finish.	0,04



# BOW

Maurizio Quargnale 2023

Registered Design

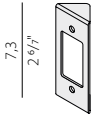
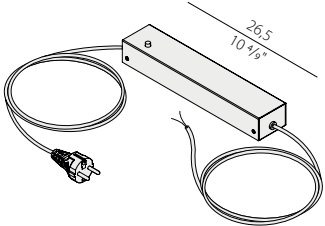
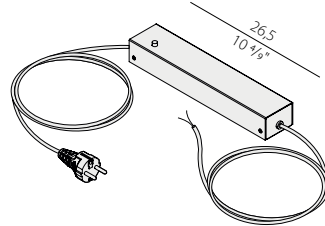
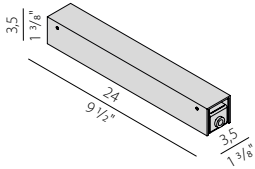
	CODICE CODE	FONTI LUMINOSE LIGHT SOURCES	kg
	<b>YFA13806.90</b> <b>YFA13883.90</b>	Staffa per fissaggio Bow in angolo a 90°, in acciaio con verniciatura poliaccrilica in colore nero satinato o per versione legno. Bracket for fixing Bow at 90° angle, made of steel with polyacrylic paint finish in mat black or for wood version.  Utilizzare n.1 staffa per ogni box di fissaggio Use no. 1 bracket for each fixing box	0,02
	<b>YKA13800.01</b>	Kit per alimentazione supplementare per composizioni multiple, costituito da scheda alimentazione 24V con n.1 molla di fissaggio, bloccacavo, cavi di alimentazione, morsetti. Additional power supply kit for multiple configurations, consisting of 24V power supply board with 1 fixing spring, cable clamp, power supply cables, terminals blocks.	0,01
	<b>YCD13806.300.060</b>	Box di alimentazione per Bow, con driver 60W/24V, con dimmer integrato e spina. Lunghezza 3m (118 1/5"). Power supply box for Bow, with 60W/24V driver, with integrated dimmer and plug. Length 3m (118 1/5").	1,14
<b>NEW</b> 	<b>YCI13806.300.075</b>	Box di alimentazione per Bow, con driver 75W/24V on/off, con pulsante e spina. Lunghezza 3m (118 1/5"). Power supply box for Bow, with 75W/24V on/off driver, with button and plug. Length 3m (118 1/5").	1,32
<b>NEW</b> 	<b>YBA13806.060.A01</b> <b>YBA13883.060.A01</b>	Box di alimentazione integrato per Bow, con driver 60W/24V on/off Integrated power supply box for Bow, with driver 60W/24V on/off	0,47

Fotometrie disponibili [www.panzeri.it](http://www.panzeri.it) / Photometric data available at [www.panzeri.it](http://www.panzeri.it)

## CODICI COLORI DISPONIBILI / COLOUR CODES AVAILABLE

**06** nero satinato  
mat black

**83** legno  
wood



L'Ufficio Tecnico Panzeri è disponibile a supporto della progettazione / Panzeri Technical Department is available to support the design

A138\_.304 n.1  
YLB138.050.0510 n.4  
XM60/24 DIM (remote) n.1

n.1 A138\_.304  
n.5 YLB138.050.0510  
n.1 XM60/24 DIM (remote)

n.1 A138\_.303  
n.6 YLB138.050.0510  
n.1 YBA138\_.060.A01

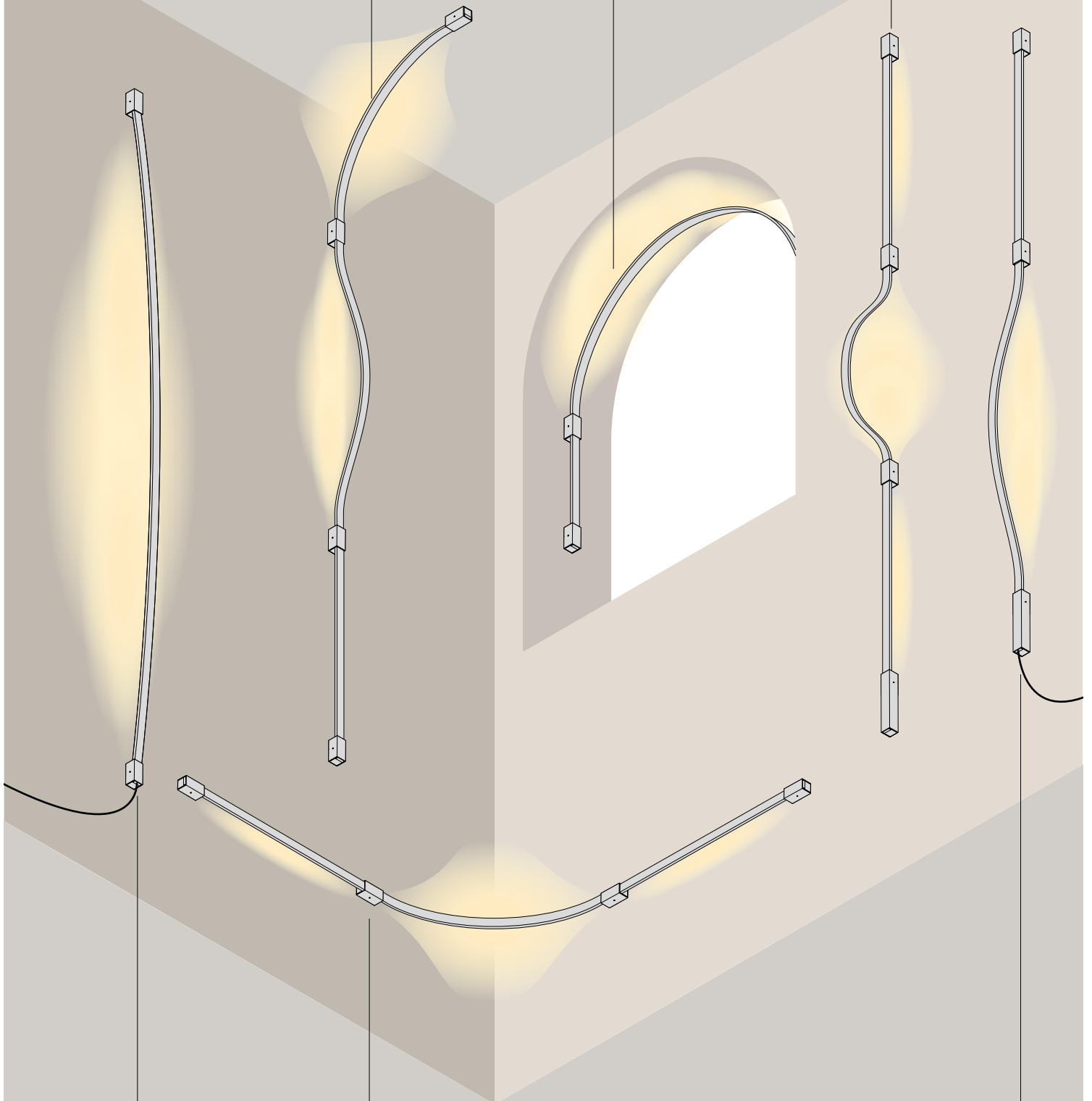

n.1 A138\_.302  
n.6 YLB138.050.0510  
n.1 YCD138\_.300.060

n.1 A138\_.304  
n.6 YLB138.050.0510  
n.1 XM60/24 DIM (remote)

A138\_.302 n.1  
YLB138.050.0510 n.3  
YBA138\_.060.A01 n.1



Sospensione a LED in alluminio estruso verniciato bianco, nero con riflettore e schermo.

Suspension LED in extruded aluminium, painted white, black with reflector and screen.

**NEW**

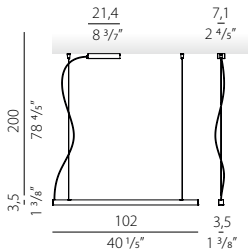

CODICE CODE	FONTI LUMINOSE LIGHT SOURCES	kg
-------------	------------------------------	----

**L23301.100.0401**

Potenza assorbita apparecchio / Luminaire power consumption 20W

2,12

**L23302.100.0401**

Flusso luminoso apparecchio / Luminaire luminous flux 1142lm  
3000K Ra>90 220-240V AC ON-OFF

**IP20 850°**

Fornito con diffusore opale e riflettore  
Supplied with opal diffuser and reflector



**L23301.100.0402**

Potenza assorbita apparecchio / Luminaire power consumption 20W

2,12

**L23302.100.0402**

Flusso luminoso apparecchio / Luminaire luminous flux 1142lm  
3000K Ra>90 220-240V AC dimmable (DALI/Push DIM)

**IP20 850°**

Fornito con diffusore opale e riflettore  
Supplied with opal diffuser and reflector

**NEW**

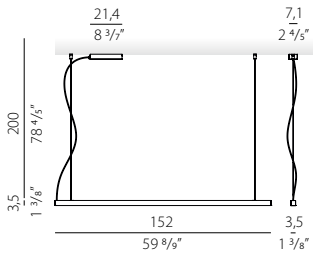

**L23301.150.0401**

Potenza assorbita apparecchio / Luminaire power consumption 29W

2,32

**L23302.150.0401**

Flusso luminoso apparecchio / Luminaire luminous flux 1713lm  
3000K Ra>90 220-240V AC ON-OFF

**IP20 850°**

Fornito con diffusore opale e riflettore  
Supplied with opal diffuser and reflector



**L23301.150.0402**

Potenza assorbita apparecchio / Luminaire power consumption 29W

2,32

**L23302.150.0402**

Flusso luminoso apparecchio / Luminaire luminous flux 1713lm  
3000K Ra>90 220-240V AC dimmable (DALI/Push DIM)

**IP20 850°**

Fornito con diffusore opale e riflettore  
Supplied with opal diffuser and reflector

**NEW**

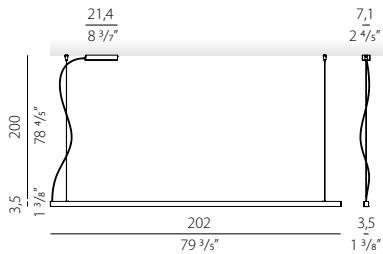

**L23301.200.0401**

Potenza assorbita apparecchio / Luminaire power consumption 39W

**L23302.200.0401**

Flusso luminoso apparecchio / Luminaire luminous flux 2284lm  
3000K Ra>90 220-240V AC ON-OFF

**IP20 850°**

Fornito con diffusore opale e riflettore  
Supplied with opal diffuser and reflector



**L23301.200.0402**

Potenza assorbita apparecchio / Luminaire power consumption 39W

**L23302.200.0402**

Flusso luminoso apparecchio / Luminaire luminous flux 2284lm  
3000K Ra>90 220-240V AC dimmable (DALI/Push DIM)

**IP20 850°**

Fornito con diffusore opale e riflettore  
Supplied with opal diffuser and reflector

**NEW**

**YDM23301.100**

Schermo diffusore in policarbonato estruso microprismato, di lunghezza 1024mm (40,3").  
Micro-prismatic extruded polycarbonate diffuser, 1024mm (40,3") long.

**YDM23301.150**

Schermo diffusore in policarbonato estruso microprismato, di lunghezza 1524mm (60").  
Micro-prismatic extruded polycarbonate diffuser, 1524mm (60") long.

**YDM23301.200**

Schermo diffusore in policarbonato estruso microprismato, di lunghezza 2024mm (79,7").  
Micro-prismatic extruded polycarbonate diffuser, 2024mm (79,7") long.

Fotometrie disponibili [www.panzeri.it](http://www.panzeri.it) / Photometric data available at [www.panzeri.it](http://www.panzeri.it)

**CODICI COLORI DISPONIBILI / COLOUR CODES AVAILABLE**

**01** bianco white  
**02** nero black



# BROOKLYN ROUND

Enzo Panzeri 2017



Lampada a sospensione e soffitto/parete in alluminio estruso curvato con schermo in policarbonato opale. Sorgente luminosa composta da modulo led a luce diretta e dimmerazione inserita nel rosone. Finitura con vernice poliacrilica in bianco, nero o ottone satinato e dettaglio del profilo a coste. Disponibile rosone per composizioni multiple di Brooklyn Round. Ideale per uffici, hall, zone living, grandi spazi.

Suspension and ceiling/wall lamp in extruded curved aluminum with opal polycarbonate screen. Light source made of LED module with direct light and dimmable driver in the canopy. Polyacrylic white, black or mat brass painted and ribbed lateral finish. Canopy for multiple configurations of Brooklyn Round is available. Ideal for offices, hall, living areas, and large areas.

	CODICE CODE	FONTI LUMINOSE LIGHT SOURCES	kg
	<p><b>L23101.360.0402</b>  <b>L23102.360.0402</b>  <b>L23119.360.0402</b></p>	<p>Potenza assorbita apparecchio / Luminaire power consumption 55W  Flusso luminoso apparecchio / Luminaire luminous flux 2965lm  3000K Ra&gt;90 220-240V AC dimmable (DALI/Push DIM)</p> <p> IP40 850°</p>	3,24
	<p><b>L23201.360.0402</b>  <b>L23202.360.0402</b>  <b>L23219.360.0402</b></p>	<p>Potenza assorbita apparecchio / Luminaire power consumption 109W  Flusso luminoso apparecchio / Luminaire luminous flux 5931lm  3000K Ra&gt;90 220-240V AC dimmable (DALI/Push DIM)</p> <p> IP40 850°</p>	5,78
	<p><b>L23101.180.0402</b>  <b>L23102.180.0402</b>  <b>L23119.180.0402</b></p>	<p>Potenza assorbita apparecchio / Luminaire power consumption 29W  Flusso luminoso apparecchio / Luminaire luminous flux 1483lm  3000K Ra&gt;90 220-240V AC dimmable (DALI/Push DIM)</p> <p> IP40 850°</p>	1,89
	<p><b>L23201.180.0402</b>  <b>L23202.180.0402</b>  <b>L23219.180.0402</b></p>	<p>Potenza assorbita apparecchio / Luminaire power consumption 55W  Flusso luminoso apparecchio / Luminaire luminous flux 2965lm  3000K Ra&gt;90 220-240V AC dimmable (DALI/Push DIM)</p> <p> IP40 850°</p>	3,38
	<p><b>XM231/23201L</b>  <b>XM231/23202L</b>  <b>XM231/23219L</b></p>	<p>Piastrina per sospensioni multiple.  Plate for multiple suspensions.</p>	0,03

# ROSONI BROOKLYN ROUND / BROOKLYN ROUND CANOPIES



Rosone per composizioni multiple di Brooklyn Round. Può alloggiare al suo interno un numero massimo di 4 driver di diverse potenze, da 4x60W/24V DALI / PUSH DIM a 2x60W/24V+2x150W/24V DALI / PUSH DIM. Gli apparecchi Brooklyn Round vanno ordinati senza rosone e driver. L'Ufficio Tecnico Panzeri è disponibile a supporto della progettazione.

Canopy for Brooklyn Round configurations. It carries a maximum of 4 drivers of different power: from 4 x60W/24V DALI / PUSH DIM to 2x60W/24V+2x150W/24V DALI / PUSH DIM. Brooklyn Round fixtures have to be ordered without canopy and driver. Panzeri Technical Department is available to support the design.

CODICE CODE	FONTI LUMINOSE LIGHT SOURCES	kg
<b>XM23101.538.0099</b>	Rosone per collegamento elettrico con 8 uscite e per raggruppamento di 7 funi in acciaio, per massimo 8 modelli Brooklyn Round.	1,17
<b>XM23102.538.0099</b>		
<b>XM23119.538.0099</b>		

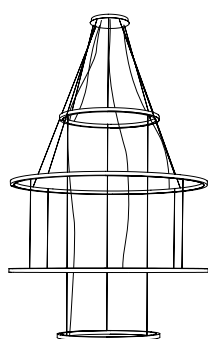
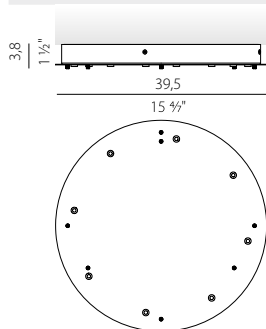

**01** Esempio di composizione con 4 apparecchi:  
Example of configuration with 4 fixtures:  
N. 1 canopy  
XM231\_\_538.0099  
N.2 Brooklyn Round  
L232\_\_360.0402 SPECIAL  
N.2 Brooklyn Round  
L231\_\_360.0402 SPECIAL

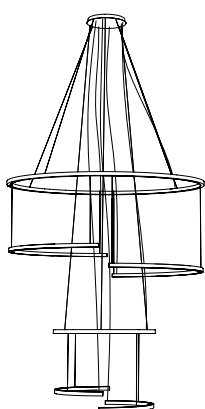

**02** Esempio di composizione con 6 apparecchi:  
Example of configuration with 6 fixtures:  
N. 1 canopy XM231\_\_538.0099  
N.1 Brooklyn Round  
L232\_\_360.0402 SPECIAL  
N.2 Brooklyn Round  
L232\_\_180.0402 SPECIAL  
N.1 Brooklyn Round  
L231\_\_360.0402 SPECIAL  
N.2 Brooklyn Round  
L231\_\_180.0402 SPECIAL

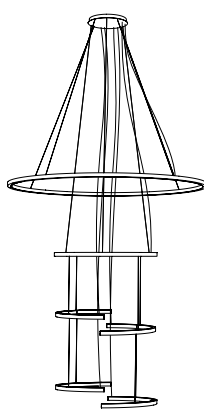

**03** Esempio di composizione con 6 apparecchi:  
Example of configuration with 6 fixtures:  
N. 1 canopy  
XM231\_\_538.0099  
N.1 Brooklyn Round  
L232\_\_360.0402 SPECIAL  
N.1 Brooklyn Round  
L231\_\_360.0402 SPECIAL  
N.4 Brooklyn Round  
L231\_\_180.0402 SPECIAL

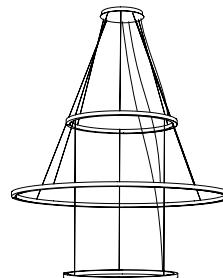

**04** Esempio di composizione con 3 apparecchi:  
Example of configuration with 3 fixtures:  
N. 1 canopy  
XM231\_\_538.0099  
N.1 Brooklyn Round  
L232\_\_360.0402 SPECIAL  
N.2 Brooklyn Round  
L231\_\_360.0402 SPECIAL

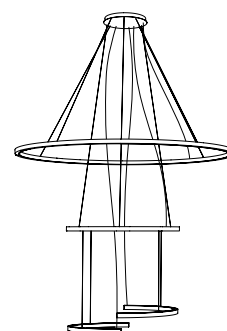

**05** Esempio di composizione con 4 apparecchi:  
Example of configuration with 4 fixtures:  
N. 1 canopy  
XM231\_\_538.0099  
N.1 Brooklyn Round  
L232\_\_360.0402 SPECIAL  
N.1 Brooklyn Round  
L231\_\_360.0402 SPECIAL  
N.2 Brooklyn Round  
L231\_\_180.0402 SPECIAL

Fotometrie disponibili [www.panzeri.it](http://www.panzeri.it) / Photometric data available at [www.panzeri.it](http://www.panzeri.it)

## CODICI COLORI DISPONIBILI / COLOUR CODES AVAILABLE

- |                           |                         |  |
|---------------------------|-------------------------|--|
| <b>01</b> bianco<br>white | <b>02</b> nero<br>black | <b>19</b> ottone satinato<br>mat brass |
|---------------------------|-------------------------|--|

# BROOKLYN ROUND

Enzo Panzeri 2017

	CODICE CODE	FONTI LUMINOSE LIGHT SOURCES	kg
	<b>P23101.360.0402</b>	Potenza assorbita apparecchio / Luminaire power consumption 55W	3,29
	<b>P23102.360.0402</b>	Flusso luminoso apparecchio / Luminaire luminous flux 2965lm	
	<b>P23119.360.0402</b>	3000K Ra>90 220-240V AC dimmable (DALI/Push DIM) <b>IP40 850°</b>	
	<b>P23201.360.0402</b>	Potenza assorbita apparecchio / Luminaire power consumption 109W	5,83
	<b>P23202.360.0402</b>	Flusso luminoso apparecchio / Luminaire luminous flux 5931lm	
	<b>P23219.360.0402</b>	3000K Ra>90 220-240V AC dimmable (DALI/Push DIM) <b>IP40 850°</b>	
	<b>P23101.180.0402</b>	Potenza assorbita apparecchio / Luminaire power consumption 29W	1,99
	<b>P23102.180.0402</b>	Flusso luminoso apparecchio / Luminaire luminous flux 1483lm	
	<b>P23119.180.0402</b>	3000K Ra>90 220-240V AC dimmable (DALI/Push DIM) <b>IP40 850°</b>	
	<b>P23201.180.0402</b>	Potenza assorbita apparecchio / Luminaire power consumption 55W	3,38
	<b>P23202.180.0402</b>	Flusso luminoso apparecchio / Luminaire luminous flux 2965lm	
	<b>P23219.180.0402</b>	3000K Ra>90 220-240V AC dimmable (DALI/Push DIM) <b>IP40 850°</b>	

Fotometrie disponibili [www.panzeri.it](http://www.panzeri.it) / Photometric data available at [www.panzeri.it](http://www.panzeri.it)

CODICI COLORI DISPONIBILI / COLOUR CODES AVAILABLE

Disponibili a richiesta LED 2700K / On request 2700K LED available

**01** bianco  
white

**02** nero  
black

**19** ottone satinato  
mat brass





# CANDLE

Silvia Poma 2006



Lampada a sospensione costituita da rosone in metallo e vetro borosilicato filettato. Vetro satinato nella parte superiore e trasparente nella sezione inferiore. Emissione di luce diffusa generata da varie fonti luminose (modulo LED o G9). Rosone in metallo verniciato poliacrilico bianco customizzabile in colore, forma e dimensione. Ideale per lobby o grandi spazi residenziali.

Suspension lamp made of a metal canopy and threaded borosilicate glass. Frosted glass in the upper part and transparent in the lower section. Emission of diffused light provided by various light sources (LED module or G9). Metal canopy in white polyacrylic paint, customizable in color, shape and size. Ideal for lobby or large residential areas.

	CODICE CODE	FONTI LUMINOSE LIGHT SOURCES	kg
	<b>L09501.000.0401</b>	Potenza assorbita apparecchio / Luminaire power consumption 4W Flusso luminoso apparecchio / Luminaire luminous flux 238lm 3000K Ra>90 220-240V AC ON-OFF <b>IP20</b>	0,62
	<b>L09501.000.0000</b>	LED retrofit bulb G9 (L max 60mm - Ø max 17,5mm) max 48W G9 <b>IP20</b>	0,58
	<b>M09501.000.0410</b>	Potenza assorbita apparecchio / Luminaire power consumption 2,8W Flusso luminoso apparecchio / Luminaire luminous flux 238lm 3000K Ra>90 24V DC <b>IP20</b> Fornito senza rosone e driver, per composizioni multiple Supplied without canopy and driver, for multiple configurations	0,37
	<b>M09501.000.0000</b>	LED retrofit bulb G9 (L max 60mm - Ø max 17,5mm) max 48W G9 <b>IP20</b> Fornito senza rosone, per composizioni multiple Supplied without canopy, for multiple configurations	0,37
	<b>M800</b>	Appendimento in policarbonato per sospensione. Polycarbonate hook for suspension.	0,01

Fotometrie disponibili [www.panzeri.it](http://www.panzeri.it) / Photometric data available at [www.panzeri.it](http://www.panzeri.it)

CODICI COLORI DISPONIBILI / COLOUR CODES AVAILABLE

**01** bianco  
white

**ROSONI E DECENTRAMENTI A PAGINA 96 / OFFSET AND CANOPIES PAGE 96**





La famiglia Carl propone apparecchi installabili con rosone ad incasso nel soffitto, per applicazioni versatili che danno vita a geometrie di luce e volumi nello spazio. Disponibili in versione fissa oppure orientabile, sono adatti ad una grande varietà di applicazioni quali strutture ricettive, spazi residenziali, showroom e negozi. Il design sobrio e discreto, che permette di armonizzare stile e funzionalità, è arricchito dalla vasta gamma di finiture in colore bianco, nero, bronzo, ottone satinato e titanio. Progettati per ospitare i nuovi LED COB ad alta efficienza, offrono comfort visivo grazie allo snoot integrato nero e al vetro zigrinato di serie. Tutte le versioni sono fornite complete di driver.

Carl is a family of lighting fittings to install in the ceiling with a recessed canopy, for versatile applications that create geometries of light and volumes in the interior space. Available in a fixed or adjustable version, they suit a variety of applications amongst which reception halls, residential spaces, retail stores and show-rooms. The sober and discreet design enables to harmonize style and functionality, and is enriched by an extensive range of finishes in white, black, bronze, mat brass and titanium. Engineered to embed new high-efficiency COB LEDs, they provide visual comfort thanks to the integrated black snoot and to the prismatic spread lens. All versions are supplied with a power supply.

	CODICE CODE	FONTI LUMINOSE LIGHT SOURCES	kg
	<b>X12201.008.2501</b>	Potenza assorbita apparecchio / Luminaire power consumption 12W	0,27
	<b>X12202.008.2501</b>	Flusso luminoso apparecchio / Luminaire luminous flux 1050lm	
	<b>X12217.008.2501</b>	3000K Ra>90 30° 350mA DC ON-OFF	
	<b>X12219.008.2501</b>	IP20 850°	
	<b>X12230.008.2501</b>	Fornito completo di driver ON-OFF Supplied with ON-OFF driver	
	<b>X12301.007.2501</b>	Potenza assorbita apparecchio / Luminaire power consumption 6,5W	0,11
	<b>X12302.007.2501</b>	Flusso luminoso apparecchio / Luminaire luminous flux 425lm	
	<b>X12317.007.2501</b>	3000K Ra>90 34° 700mA DC ON-OFF	
	<b>X12319.007.2501</b>	IP20 850°	
	<b>X12330.007.2501</b>	Fornito completo di driver ON-OFF Supplied with ON-OFF driver	
	<b>X12301.010.2502</b>	Potenza assorbita apparecchio / Luminaire power consumption 18W	0,29
	<b>X12302.010.2502</b>	Flusso luminoso apparecchio / Luminaire luminous flux 1436lm	
	<b>X12317.010.2502</b>	3000K Ra>90 30° 500mA DC dimmable (DALI/Push DIM)	
	<b>X12319.010.2502</b>	IP20 850°	
	<b>X12330.010.2502</b>	Fornito completo di driver DALI/Push DIM Supplied with DALI/Push DIM driver	

Fotometrie disponibili [www.panzeri.it](http://www.panzeri.it) / Photometric data available at [www.panzeri.it](http://www.panzeri.it) installation conditions

UGR < 16 in funzione delle condizioni di installazione / UGR < 16 Depending on installation conditions

CODICI COLORI DISPONIBILI / COLOUR CODES AVAILABLE

Disponibili a richiesta LED 2700K / On request 2700K LED available

**01** bianco  
white

**02** nero  
black

**17** bronzo  
bronze

**19** ottone satinato  
mat brass

**30** titanio  
titanium





# CARL

Officina Panzeri 2021



Modello che combina una coppia di faretto Carl direzionabili, per creare molteplici giochi di luce nell'ambiente. Applicabile a soffitto o parete, completa la gamma Carl a cui può essere accostato anche per le finiture disponibili di colore bianco, nero, bronzo, ottone satinato e titanio. Il driver integrato nella base offre la possibilità di regolare l'intensità luminosa tramite dispositivi 1-10V o Push DIM.

Lighting fitting that combines a pair of Carl adjustable projectors, to create multiple plays of light in the interior space. To install ceiling or wall mount, it complements the Carl family also thanks to the available finishes in white, black, bronze, mat brass and bronze. The power supply integrated in the base provides the possibility to dim the light intensity through 1-10V or Push DIM dimming protocol.

	CODICE CODE	FONTI LUMINOSE LIGHT SOURCES	kg
	<b>P12501.033.0403</b>	Potenza assorbita apparecchio / Luminaire power consumption 43W	1,20
	<b>P12502.033.0403</b>	Flusso luminoso apparecchio / Luminaire luminous flux 2872lm	
	<b>P12517.033.0403</b>	3000K Ra>90 30° 220-240V AC dimmable (1-10V/Push DIM)	
	<b>P12519.033.0403</b>	IP20	
	<b>P12530.033.0403</b>		

Fotometrie disponibili [www.panzeri.it](http://www.panzeri.it) / Photometric data available at [www.panzeri.it](http://www.panzeri.it)

UGR < 16 in funzione delle condizioni di installazione / UGR < 16 depending on installation conditions

CODICI COLORI DISPONIBILI / COLOUR CODES AVAILABLE

Disponibili a richiesta LED 2700K / On request 2700K LED available

- |                           |                         |                            |  |                               |
|---------------------------|-------------------------|----------------------------|--|-------------------------------|
| <b>01</b> bianco<br>white | <b>02</b> nero<br>black | <b>17</b> bronzo<br>bronze | <b>19</b> ottone satinato<br>mat brass | <b>30</b> titanio<br>titanium |
|---------------------------|-------------------------|----------------------------|--|-------------------------------|



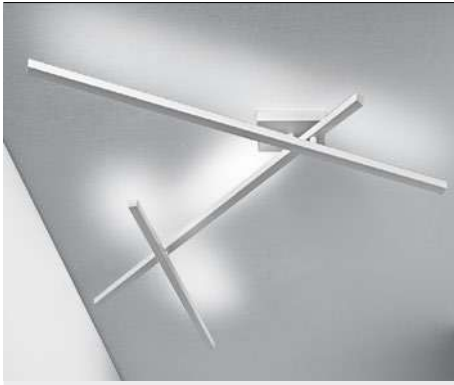

Disponibile nelle versioni da parete o a soffitto. Formata da metallo tagliato a laser, piegato e successivamente saldata con filo d'argento. Versione a soffitto con meccanismo rotatorio tornito dal pieno. Diffusione di luce indiretta attraverso schermo trasparente di protezione. Fonte luminosa costituita da modulo LED. Dimmerazione 1-10V/Push DIM di serie sulla versione con 3 bracci. Lampada finita con vernice poliaccrilica in bianco o nero. La versione a soffitto è disponibile con 2 o 3 sezioni rotanti (350°), mentre quella a parete è una sezione fissa. Ideale per locali ampi e difficili da illuminare.

Ceiling or wall lamp in laser-cut metal folded and then welded with silver thread. The ceiling version has a rotary mechanism turned from solid. Indirect light through transparent screen. Light source consisting of LED module. The version with 3 arms is provided with dimming 1-10V/Push DIM driver. Lamp painted in white or black polyacrylic paint. The ceiling version has 2 or 3 rotating sections (350°), while the wall version is a fixed section. Ideal for large rooms difficult to illuminate.

	CODICE CODE	FONTI LUMINOSE LIGHT SOURCES	kg
	<b>P06401.003.0403</b> <b>P06402.003.0403</b>	Potenza assorbita apparecchio / Luminaire power consumption 56W Flusso luminoso apparecchio / Luminaire luminous flux 5420lm 3000K Ra>90 220-240V AC dimmable (1-10V/Push DIM) <b>LED IP20 850°</b>	8,30
	<b>P06401.002.0401</b> <b>P06402.002.0401</b>	Potenza assorbita apparecchio / Luminaire power consumption 28,5W Flusso luminoso apparecchio / Luminaire luminous flux 2519lm 3000K Ra>90 220-240V AC ON-OFF <b>LED IP20 850°</b>	4,08
	<b>A06401.000.0401</b> <b>A06402.000.0401</b>	Potenza assorbita apparecchio / Luminaire power consumption 13W Flusso luminoso apparecchio / Luminaire luminous flux 1025lm 3000K Ra>90 220-240V AC ON-OFF <b>LED IP20 850°</b>	1,79

Fotometrie disponibili [www.panzeri.it](http://www.panzeri.it) / Photometric data available at [www.panzeri.it](http://www.panzeri.it)

**CODICI COLORI DISPONIBILI / COLOUR CODES AVAILABLE**

- 01** bianco / white
- 02** nero / black

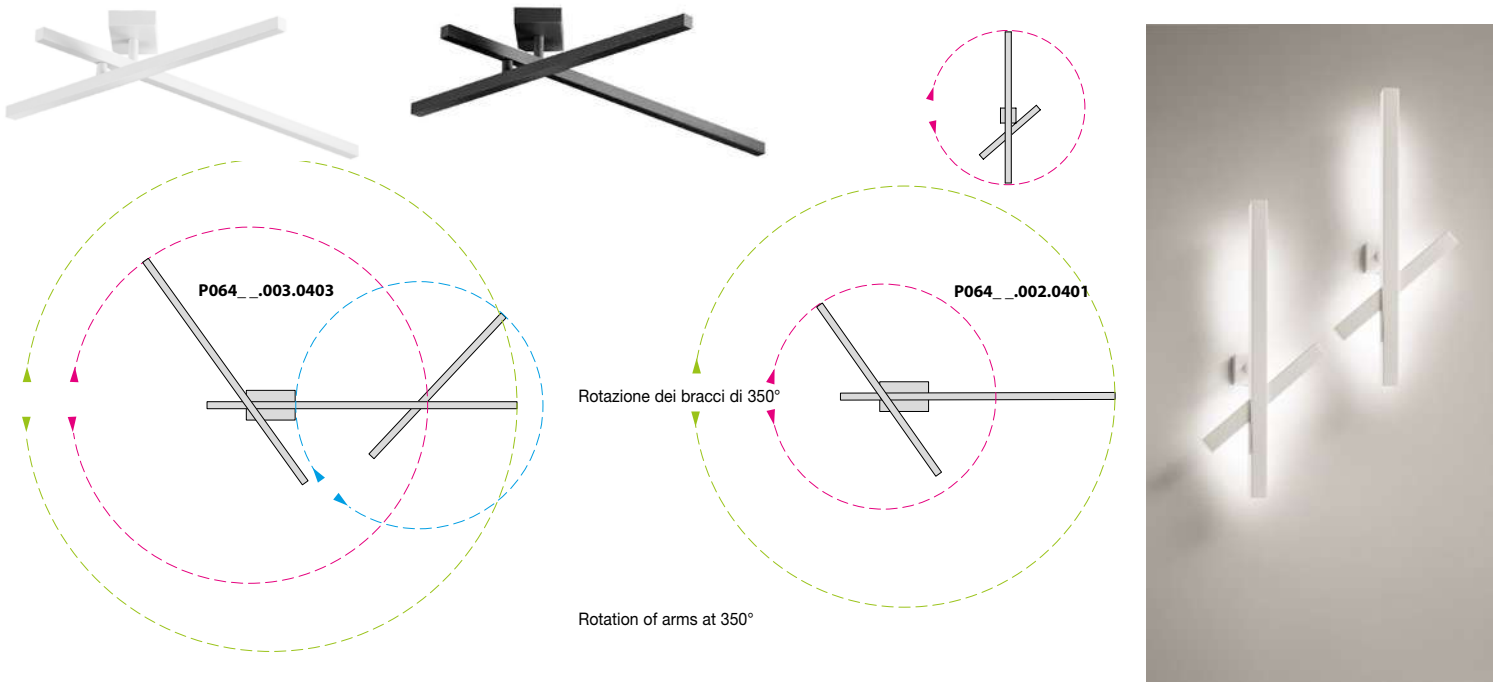



Lampada a parete in metallo tagliato a laser con diffusore in vetro acidato. Luce sia diretta che indiretta ottenuta da fonte luminosa LED. Fascia metallica rifinita con vernice poliaccrilica bianca, ottone satinato o con decorazione a mano in foglia oro e fissata alla struttura senza l'ausilio di viti a vista attraverso sistema elastico. Le fasce assemblate creano un simmetrico gioco di luci e ombre sulla struttura. Ideale per corridoi o uso residenziale.

Wall lamp in laser-cut metal and glass diffuser. Direct and indirect LED light. Metal cover in white or mat brass and fixed without any visible screw thanks to an elastic system. The assembled covers create a symmetrical play of lights and shadows on the structure. Ideal for corridors or residential use.

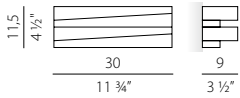

CODICE CODE	FONTI LUMINOSE LIGHT SOURCES	kg
<b>A04901.030.0101</b> <b>A04919.030.0101</b> <b>A04921.030.0101</b>	Potenza assorbita apparecchio / Luminaire power consumption 20W Flusso luminoso apparecchio / Luminaire luminous flux 2340lm 3000K Ra>80 220-240V AC ON-OFF IP20	1,22
<b>A04901.030.0102</b> <b>A04919.030.0102</b> <b>A04921.030.0102</b>	Potenza assorbita apparecchio / Luminaire power consumption 20W Flusso luminoso apparecchio / Luminaire luminous flux 2340lm 3000K Ra>80 220-240V AC dimmable (DALI/Push DIM) IP20	1,22
<b>A04901.060.0101</b> <b>A04919.060.0101</b> <b>A04921.060.0101</b>	Potenza assorbita apparecchio / Luminaire power consumption 40W Flusso luminoso apparecchio / Luminaire luminous flux 4680lm 3000K Ra>80 220-240V AC ON-OFF IP20	2,32
<b>A04901.060.0102</b> <b>A04919.060.0102</b> <b>A04921.060.0102</b>	Potenza assorbita apparecchio / Luminaire power consumption 40W Flusso luminoso apparecchio / Luminaire luminous flux 4680lm 3000K Ra>80 220-240V AC dimmable (DALI/Push DIM) IP20	2,32

Fotometrie disponibili [www.panzeri.it](http://www.panzeri.it) / Photometric data available at [www.panzeri.it](http://www.panzeri.it)

CODICI COLORI DISPONIBILI / COLOUR CODES AVAILABLE

Disponibili a richiesta LED 2700K / On request 2700K LED available

**01** bianco  
white

**19** ottone satinato  
mat brass









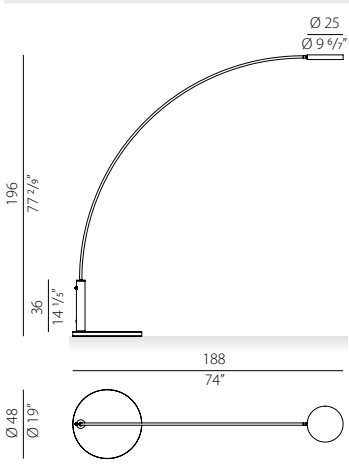

**21** foglia oro  
gold leaf



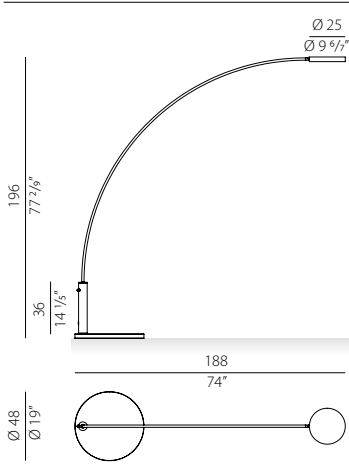

Con le sue versioni sospensione, parete, soffitto e terra indoor/outdoor, Dip porta la luce dove è necessario, valorizzando con classe ed eleganza ambienti residenziali e commerciali. Il design minimale degli apparecchi viene enfatizzato da un'accurata selezione di finiture specifiche per ogni tipologia di installazione che nella versione terra indoor, lavorano in abbinamento alla base in marmo nero marquina o travertino. Versione da sospensione con cavo di alimentazione regolabile in altezza; versioni da terra, parete e soffitto caratterizzate da un braccio curvo che sostiene la testa orientabile, permettendo di scegliere la direzione del fascio luminoso.

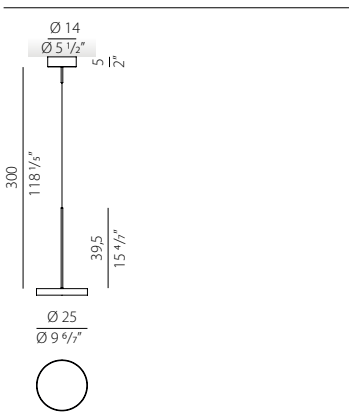



Dip brings light to dedicated areas, enhancing residential and commercial environments with class and elegance thanks to suspension, wall, ceiling and floor indoor/outdoor versions. The minimalist design of the luminaires is emphasised by a careful selection of specific finishes for each type of installation which, in the floor-standing version for indoor use, are characterised by black marquina marble or travertine. Suspension version with height-adjustable power supply cable; floor, wall and ceiling versions characterized by a curved arm that supports the adjustable head, allowing to direction the light beam.

NEW	CODICE CODE	FONTI LUMINOSE LIGHT SOURCES	kg
	 <p><b>T08517.170.0527</b> <b>T08528.170.0527</b></p>	<p>Potenza assorbita apparecchio / Luminaire power consumption 18W Flusso luminoso apparecchio / Luminaire luminous flux 1931lm 2700K Ra&gt;90 220-240V AC dimmable (Push DIM)</p> <p> <b>IP40</b> </p> <p>Base di appoggio in marmo travertino. Fornito completo di interruttore push, cavo 2,5m e spina</p> <p>Base in travertine marble. Supplied complete with push switch, 2,5m cable and plug</p>	17,00
	 <p><b>T08605.170.0527</b> <b>T08606.170.0527</b> <b>T08617.170.0527</b></p>	<p>Potenza assorbita apparecchio / Luminaire power consumption 18W Flusso luminoso apparecchio / Luminaire luminous flux 1931lm 2700K Ra&gt;90 220-240V AC dimmable (Push DIM)</p> <p> <b>IP40</b> </p> <p>Base di appoggio in marmo nero marquina. Fornito completo di interruttore push, cavo 2,5m e spina</p> <p>Base in black marquina marble. Supplied complete with push switch, 2,5m cable and plug</p>	17,00
	 <p><b>L08405.000.0502</b> <b>L08406.000.0502</b> <b>L08417.000.0502</b> <b>L08428.000.0502</b></p>	<p>Potenza assorbita apparecchio / Luminaire power consumption 18W Flusso luminoso apparecchio / Luminaire luminous flux 1931lm 2700K Ra&gt;90 220-240V AC dimmable (DALI/Push DIM)</p> <p> <b>IP40</b></p>	1,90

# DIP

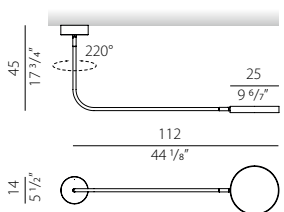
Hangar Design Group 2024

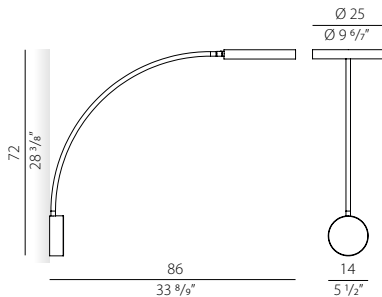
Registered Design

	CODICE CODE	FONTI LUMINOSE LIGHT SOURCES	kg
	<b>P08405.090.0502</b>	Potenza assorbita apparecchio / Luminaire power consumption 18W	2,20
	<b>P08406.090.0502</b>	Flusso luminoso apparecchio / Luminaire luminous flux 1931lm	
	<b>P08417.090.0502</b>	2700K Ra>90 220-240V AC dimmable (DALI/Push DIM)	
	<b>P08428.090.0502</b>	 IP20	
	<b>A08405.070.0502</b>	Potenza assorbita apparecchio / Luminaire power consumption 18W	2,50
	<b>A08406.070.0502</b>	Flusso luminoso apparecchio / Luminaire luminous flux 1931lm	
	<b>A08417.070.0502</b>	2700K Ra>90 220-240V AC dimmable (DALI/Push DIM)	
	<b>A08428.070.0502</b>	 IP40	

Fotometrie disponibili [www.panzeri.it](http://www.panzeri.it) / Photometric data available at [www.panzeri.it](http://www.panzeri.it)

## CODICI COLORI DISPONIBILI / COLOUR CODES AVAILABLE

**05** champagne  
champagne

**06** nero satinato  
mat black

**17** bronzo  
bronze

**28** bianco soft materico  
textured soft white





# FIREFLY IN THE SKY

Matteo Thun 2019

Registered Design



Firefly in the sky è un apparecchio a batteria da tavolo. La testa removibile racchiude sistema di aggancio magnetico, batteria ricaricabile tramite USB-C, sorgente LED e comando Step DIM a 5 regolazioni di intensità luminosa. In funzione delle condizioni di utilizzo per una ricarica di circa 4 ore si stima un'autonomia di circa 6 ore con intensità della luce al 100% e di circa 24 ore con intensità della luce al 25%. Base antiscivolo già in dotazione. Verde oliva materico, bianco soft materico, terracotta naturale materico e corten si aggiungono alle finiture disponibili nero satinato, bronzo e champagne.

Firefly in the sky is a battery table lamp. The removable head contains magnetic coupling system, rechargeable battery via USB-C, LED source and Step DIM control with 5 light intensity settings. Depending on the conditions of use for a recharge of approximately 4 hours, an autonomy of approximately 6 hours is estimated with 100% light intensity and approximately 24 hours with 25% light intensity. Anti-slip base included. Textured olive green, textured soft white, textured natural terracotta and corten are added to mat black, bronze and champagne finishes available.

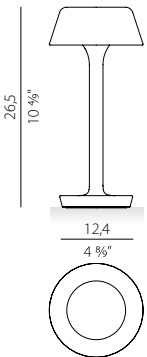

CODICE CODE	FONTI LUMINOSE LIGHT SOURCES	kg
-------------	------------------------------	----



- C07805.011.0514**
- C07806.011.0514**
- C07816.011.0514**
- C07817.011.0514**
- C07827.011.0514**
- C07828.011.0514**
- C07829.011.0514**

Potenza assorbita apparecchio / Luminaire power consumption 2W  
 Flusso luminoso apparecchio / Luminaire luminous flux 134lm  
 2700K Ra>90 5V DC battery Dimmable (Step DIM)

**LED IP65**

Interruttore incluso / Switch included

In funzione delle condizioni di utilizzo per una ricarica di circa 4 ore si stima un'autonomia di circa 6 ore con intensità della luce al 100% e di circa 24 ore con intensità della luce al 25%. Indicatore LED per lo stato di carica. La carica avviene tramite USB-C. Caricabatteria e cavetto inclusi.

Depending on the conditions of use for a recharge of approximately 4 hours, an autonomy of approximately 6 hours is estimated with 100% light intensity and approximately 24 hours with 25% light intensity. LED indicator for the load status. Charging takes place via USB-C. Battery charger and cable Included.

## YRM07802.010

Vassoio per ricarica multipla di massimo 10 modelli Firefly in the Sky. Multiple charging tray for up to 10 Firefly in the Sky models.

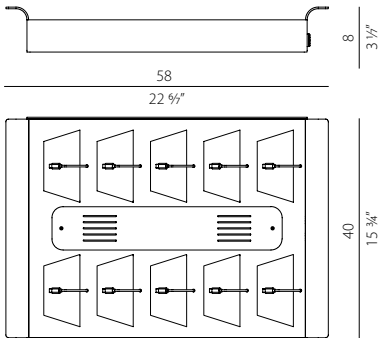

Fotometrie disponibili [www.panzeri.it](http://www.panzeri.it) / Photometric data available at [www.panzeri.it](http://www.panzeri.it)

### CODICI COLORI DISPONIBILI / COLOUR CODES AVAILABLE

- 05** champagne champagne
- 06** nero satinato mat black
- 16** corten corten
- 17** bronzo bronze
- 27** verde oliva materico textured olive green
- 28** bianco soft materico textured soft white
- 29** terracotta naturale materico textured natural terracotta



reddot winner 2020



Lampada a sospensione e a parete ad emissione diretta e indiretta. Sorgente luminosa LED, con driver ON-OFF con accensione separata o DALI/Push DIM. Finitura con vernice poliacrilica in bianco o nero e finitura frontale del profilo liscia. Schermo in policarbonato estruso opale o microprismatico. Ideale per uffici, corridoi, scale.

Wall and suspension luminaire with direct and indirect light emission. Light source made of LED module with separate switching ON-OFF or DALI/Push DIM integrated drivers. Finish in polyacrylic paint in white or black and smooth front finish of the profile. Diffusor in opal or micro prismatic polycarbonate. Ideal for offices, corridors, stairways.











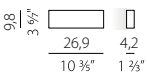

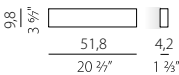
	CODICE CODE	FONTI LUMINOSE LIGHT SOURCES	kg
	<b>L24647.150.0401</b>	Potenza assorbita apparecchio / Luminaire power consumption 56W Flusso luminoso apparecchio / Luminaire luminous flux 4541lm 3000K Ra>90 60° / 87° 220-240V AC ON-OFF <b>IP40</b> Fornito con predisposizione per doppia accensione, n.2 diffusori opali e n.1 diffusore microprismatico Supplied with predisposition for double switch, n.2 opal diffusers and n.1 microprismatic diffuser	5,08
	<b>L24649.150.0401</b>	Potenza assorbita apparecchio / Luminaire power consumption 54W Flusso luminoso apparecchio / Luminaire luminous flux 4541lm 3000K Ra>90 60° / 87° 220-240V AC dimmable (DALI/Push DIM) <b>IP40</b> Fornito con n.2 diffusori opali e n.1 diffusore microprismatico Supplied with n. 2 opal diffusers and n.1 microprismatic diffuser	5,08
	<b>L24647.200.0401</b>	Potenza assorbita apparecchio / Luminaire power consumption 72W Flusso luminoso apparecchio / Luminaire luminous flux 6055lm 3000K Ra>90 60° / 87° 220-240V AC ON-OFF <b>IP40</b> Fornito con predisposizione per doppia accensione, n.2 diffusori opali e n.1 diffusore microprismatico Supplied with predisposition for double switch, n.2 opal diffusers and n.1 microprismatic diffuser	6,45
	<b>L24649.200.0401</b>	Potenza assorbita apparecchio / Luminaire power consumption 70W Flusso luminoso apparecchio / Luminaire luminous flux 6055lm 3000K Ra>90 60° / 87° 220-240V AC dimmable (DALI/Push DIM) <b>IP40</b> Fornito con n.2 diffusori opali e n.1 diffusore microprismatico Supplied with n.2 opal diffusers and n.1 microprismatic diffuser	6,45





# GIANO

Officina Panzeri 2017

	CODICE CODE	FONTI LUMINOSE LIGHT SOURCES	kg
	 <b>A24646.025.0401</b> <b>A24648.025.0401</b>	Potenza assorbita apparecchio / Luminaire power consumption 11W Flusso luminoso apparecchio / Luminaire luminous flux 614lm 3000K Ra>90 220-240V AC ON-OFF  <b>IP40</b> Fornito con n.2 diffusori opali Supplied with n.2 opal diffusers	0,86
	 <b>A24646.050.0401</b> <b>A24648.050.0401</b>	Potenza assorbita apparecchio / Luminaire power consumption 19W Flusso luminoso apparecchio / Luminaire luminous flux 1228lm 3000K Ra>90 220-240V AC ON-OFF  <b>IP40</b> Fornito con n.2 diffusori opali Supplied with n.2 opal diffusers	1,30
	 <b>A24646.050.0402</b> <b>A24648.050.0402</b>	Potenza assorbita apparecchio / Luminaire power consumption 19W Flusso luminoso apparecchio / Luminaire luminous flux 1228lm 3000K Ra>90 220-240V AC dimmable (DALI/Push DIM)  <b>IP40</b> Fornito con n.2 diffusori opali Supplied with n.2 opal diffusers	1,32
	 <b>A24646.100.0401</b> <b>A24648.100.0401</b>	Potenza assorbita apparecchio / Luminaire power consumption 38W Flusso luminoso apparecchio / Luminaire luminous flux 2456lm 3000K Ra>90 220-240V AC ON-OFF  <b>IP40</b> Doppia accensione. Fornito con n.2 diffusori opali Double switch. Supplied with n.2 opal diffusers	2,60
	 <b>A24646.100.0402</b> <b>A24648.100.0402</b>	Potenza assorbita apparecchio / Luminaire power consumption 36W Flusso luminoso apparecchio / Luminaire luminous flux 2456lm 3000K Ra>90 220-240V AC dimmable (DALI/Push DIM)  <b>IP40</b> Fornito con n.2 diffusori opali Supplied with n.2 opal diffusers	2,64
	 <b>A24646.150.0401</b> <b>A24648.150.0401</b>	Potenza assorbita apparecchio / Luminaire power consumption 56W Flusso luminoso apparecchio / Luminaire luminous flux 3683lm 3000K Ra>90 220-240V AC ON-OFF  <b>IP40</b> Fornito con predisposizione per doppia accensione, n.2 diffusori opali Supplied with predisposition for double switch, n. 2 opal diffusers	3,62
	 <b>A24646.150.0402</b> <b>A24648.150.0402</b>	Potenza assorbita apparecchio / Luminaire power consumption 54W Flusso luminoso apparecchio / Luminaire luminous flux 3683lm 3000K Ra>90 220-240V AC dimmable (DALI/Push DIM)  <b>IP40</b> Fornito con n.2 diffusori opali Supplied with n.2 opal diffusers	3,92

Fotometrie disponibili [www.panzeri.it](http://www.panzeri.it) / Photometric data available at [www.panzeri.it](http://www.panzeri.it) UGR < 19 in funzione delle condizioni di installazione / UGR < 19 depending on installation conditions

## CODICI COLORI DISPONIBILI / COLOUR CODES AVAILABLE

**46** bianco/schermo opalino / white/opal screen    **47** bianco/schermo prismato / white/prismatic screen    **48** nero/schermo opalino / black/opal screen    **49** nero/schermo prismato / black/prismatic screen

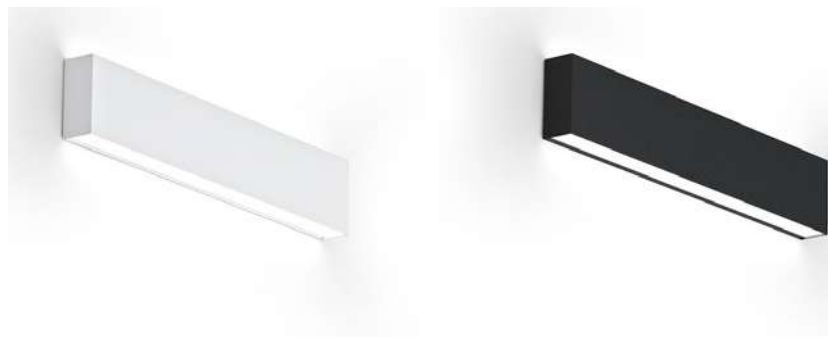



Lampada a sospensione, tavolo o soffitto costituita da vetro opale satinato soffiato e montatura in metallo rifinita con vernice poliaccrilica color bianco. Emissione di luce diffusa con possibilità di scelta di varie fonti luminose (LED, G9, E27). Omogenea diffusione della luce all'interno del vetro, senza zone in ombra. Ideale per un uso residenziale o per aree lobby in composizioni multiple.

Suspension, table and ceiling lamps in blown opal glass. Metal frame in white polyacrylic paint. Diffused light provided by different light sources (LED, G9, E27). Perfect and homogeneous distribution of the light, without any shadow. Ideal for residential use or for lobby areas in multiple compositions.

	CODICE CODE	FONTI LUMINOSE LIGHT SOURCES	kg
	<b>L06501.022.0401</b>	Potenza assorbita apparecchio / Luminaire power consumption 11W Flusso luminoso apparecchio / Luminaire luminous flux 929lm 3000K Ra>90 220-240V AC ON-OFF <b>IP20</b>	1,13
	<b>L06501.022.0000</b>	LED retrofit bulb G9 (L max 60mm - Ø max 17,5mm) max 60W G9 <b>IP20</b>	1,20
	<b>L06501.037.0402</b>	Potenza assorbita apparecchio / Luminaire power consumption 27W Flusso luminoso apparecchio / Luminaire luminous flux 2525lm 3000K Ra>90 220-240V AC dimmable (DALI/Push DIM) <b>IP20</b>	3,80
	<b>L06501.037.0000</b>	LED retrofit bulb E27 (L max 140mm - Ø max 65mm) max 150W E27 <b>IP20</b>	3,80
	<b>L06501.045.0402</b>	Potenza assorbita apparecchio / Luminaire power consumption 27W Flusso luminoso apparecchio / Luminaire luminous flux 2525lm 3000K Ra>90 220-240V AC dimmable (DALI/Push DIM) <b>IP20</b>	4,70
	<b>L06501.045.0000</b>	LED retrofit bulb E27 (L max 140mm - Ø max 65mm) max 150W E27 <b>IP20</b>	5,30
	<b>P06501.037.0402</b>	Potenza assorbita apparecchio / Luminaire power consumption 20W Flusso luminoso apparecchio / Luminaire luminous flux 1840lm 3000K Ra>90 220-240V AC dimmable (DALI/Push DIM) <b>IP20</b>	3,40
	<b>P06501.037.0000</b>	LED retrofit bulb E27 (L max 100mm - Ø max 55mm) max 150W E27 <b>IP20</b>	3,40
	<b>P06501.045.0402</b>	Potenza assorbita apparecchio / Luminaire power consumption 20W Flusso luminoso apparecchio / Luminaire luminous flux 1840lm 3000K Ra>90 220-240V AC dimmable (DALI/Push DIM) <b>IP20</b>	5,12
	<b>P06501.045.0000</b>	LED retrofit bulb E27 (L max 100mm - Ø max 55mm) max 150W E27 <b>IP20</b>	5,12
	<b>C06501.022.0401</b>	Potenza assorbita apparecchio / Luminaire power consumption 11W Flusso luminoso apparecchio / Luminaire luminous flux 692lm 3000K Ra>90 220-240V AC ON-OFF <b>IP40</b>	0,74

Fotometrie disponibili [www.panzeri.it](http://www.panzeri.it) / Photometric data available at [www.panzeri.it](http://www.panzeri.it)

CODICI COLORI DISPONIBILI / COLOUR CODES AVAILABLE

**01** bianco  
white



Lampada a sospensione e soffitto con diffusore microprismato a luminanza controllata. Versione a soffitto con emissione diretta attraverso modulo LED disponibile anche tunable white. La versione sospensione combina emissione diretta e indiretta dimmerabili. Corpo lampada in alluminio tornito rifinito con vernice poliaccrilica nelle versioni esterno nero e interno oro o esterno bianco e interno oro. Possibili colori custom su richiesta. Ideale per hall, zone living, grandi spazi, e uffici.

Suspension and ceiling lamp with microprismatic polycarbonate screen for controlled luminance. Ceiling version with direct light through LED modules also available tunable white. The suspension combines dimmable direct and indirect light. Lamp structure in turned aluminium finished in polyacrylic painted outside black and gold inside or outside white and gold inside. Custom colors are available on request. Ideal for halls, living areas, and public spaces and offices.

	CODICE CODE	FONTE LUMINOSE LIGHT SOURCES	kg
	 <b>L09280.050.0402</b> <b>L09281.050.0402</b>	Potenza assorbita apparecchio / Luminaire power consumption 36W Flusso luminoso apparecchio / Luminaire luminous flux 2916lm 3000K Ra>90 220-240V AC dimmable (DALI/Push DIM) IP20	6,27
	 <b>L09280.080.0402</b> <b>L09281.080.0402</b>	Potenza assorbita apparecchio / Luminaire power consumption 82W Flusso luminoso apparecchio / Luminaire luminous flux 7782lm 3000K Ra>90 220-240V AC dimmable (DALI/Push DIM) IP20	10,97
	 <b>P09280.050.0402</b> <b>P09281.050.0402</b>	Potenza assorbita apparecchio / Luminaire power consumption 25W Flusso luminoso apparecchio / Luminaire luminous flux 1877lm 3000K Ra>90 220-240V AC dimmable (DALI/Push DIM) IP20	5,22
	 <b>P09280.050.9017</b> <b>P09281.050.9017</b>	Potenza assorbita apparecchio / Luminaire power consumption 30W Flusso luminoso apparecchio / Luminaire luminous flux 1794lm min. / 2046lm max 2700-6500K Ra>90 220-240V AC tunable white IP20 Bianco dinamico, driver DALI DT8 / Switch dim / Color switch Tunable white, driver DALI DT8 / Switch dim / Color switch	5,22
	 <b>P09280.080.0402</b> <b>P09281.080.0402</b>	Potenza assorbita apparecchio / Luminaire power consumption 71W Flusso luminoso apparecchio / Luminaire luminous flux 6743lm 3000K Ra>90 220-240V AC dimmable (DALI/Push DIM) IP20	10,07
	 <b>P09280.080.9017</b> <b>P09281.080.9017</b>	Potenza assorbita apparecchio / Luminaire power consumption 69W Flusso luminoso apparecchio / Luminaire luminous flux 6518lm min. / 7190lm max 2700-6500K Ra>90 220-240V AC tunable white IP20 Bianco dinamico, driver DALI DT8 / Switch dim / Color switch Tunable white, driver DALI DT8 / Switch dim / Color switch	10,07

Fotometrie disponibili [www.panzeri.it](http://www.panzeri.it) / Photometric data available at [www.panzeri.it](http://www.panzeri.it)

UGR < 19 in funzione delle condizioni di installazione / UGR < 19 depending on installation conditions

#### CODICI COLORI DISPONIBILI / COLOUR CODES AVAILABLE

**80** nero/oro  
black/gold

**81** bianco/oro  
white/gold

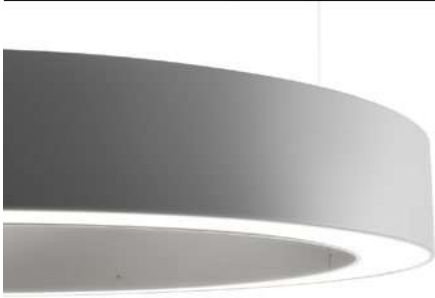

Anello a sospensione in alluminio piegato con schermo superiore e inferiore in policarbonato opalino ad alta trasmittanza. Emissione di luce diretta e indiretta oppure solo diretta, tramite modulo LED. Dimmerazione DALI/ Push DIM di serie su tutte le versioni biemissione. Possibilità di avere LED 4000K su richiesta. Anello rifinito con vernice poliaccrilica color bianco, nero o decorata a mano con foglia oro. Possibilità di personalizzare i colori. Sospensione tramite 3 cavi in acciaio (6 nella versione ø 300cm). Spedizione del prodotto in un pezzo unico. La versione ø 300cm viene spedita in due semicerchi. Ideale per ambienti residenziali, grandi composizioni per uffici, strutture ricettive e spazi pubblici.

Suspension ring in curved aluminium with top and bottom high-transmittance screens in opal polycarbonate. Emission of both direct and indirect light or direct only, through LED modules. All double emission versions provided with DALI/Push DIM dimming. Possibility of having LED 4000K upon request. Ring eventually finished in polyacrylic white paint or black hand-decorated with golden leaf. Possibility to customize the colors. Suspended by means of 3 steel cables (6 in the ø 300cm version). Delivery of the product in a single piece. The ø 300cm version is shipped in two semicircles. Ideal for residential spaces, great compositions for offices, hospitality and public spaces.

## GOLDEN RING

	CODICE CODE	FONTI LUMINOSE LIGHT SOURCES	kg
	<b>L08101.080.0408</b> <b>L08102.080.0408</b> <b>L08121.080.0408</b>	Potenza assorbita apparecchio / Luminaire power consumption 45W Flusso luminoso apparecchio / Luminaire luminous flux 3053lm 3000K Ra>90 220-240V AC ON-OFF IP40 850°	9,61
	<b>L08101.080.0402</b> <b>L08102.080.0402</b> <b>L08121.080.0402</b>	Potenza assorbita apparecchio / Luminaire power consumption 87W Flusso luminoso apparecchio / Luminaire luminous flux 6106lm 3000K Ra>90 220-240V AC dimmable (DALI/Push DIM) IP40 850°	10,68
	<b>L08101.120.0402</b> <b>L08102.120.0402</b> <b>L08121.120.0402</b>	Potenza assorbita apparecchio / Luminaire power consumption 150W Flusso luminoso apparecchio / Luminaire luminous flux 10466lm 3000K Ra>90 220-240V AC dimmable (DALI/Push DIM) IP40 850°	15,59
	<b>L08101.180.0402</b> <b>L08102.180.0402</b> <b>L08121.180.0402</b>	Potenza assorbita apparecchio / Luminaire power consumption 220W Flusso luminoso apparecchio / Luminaire luminous flux 15699lm 3000K Ra>90 220-240V AC dimmable (DALI/Push DIM) IP40 850°	23,05
	<b>M8101-3</b> <b>M8102-3</b> <b>M8121-3</b>	Rosone per collegamento elettrico e per raggruppamento di 3 funi in acciaio. 0,58 Canopy for power supply and to join 3 steel cables.	0,58

# RING COLLECTION

Enzo Panzeri 2015

Registered Design

	CODICE CODE	FONTI LUMINOSE LIGHT SOURCES	kg
	<b>L08101.300.0402</b>	Potenza assorbita apparecchio / Luminaire power consumption 370W	41,48
	<b>L08102.300.0402</b>	Flusso luminoso apparecchio / Luminaire luminous flux 26166lm	
	<b>L08121.300.0402</b>	3000K Ra>90 220-240V AC dimmable (DALI/Push DIM)	
		<b>LED IP40 850°</b> Apparecchio fornito in 2 parti da montare Fixture in 2 parts to compose	

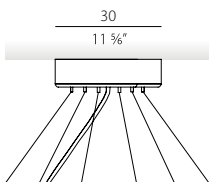

**M8101-6**  
**M8102-6**  
**M8121-6**

Rosone per collegamento elettrico e per raggruppamento di 6 funi in acciaio. 2,91  
Canopy for power supply and to join 6 steel cables.



Fotometrie disponibili [www.panzeri.it](http://www.panzeri.it) / Photometric data available at [www.panzeri.it](http://www.panzeri.it)

CODICI COLORI DISPONIBILI / COLOUR CODES AVAILABLE

Disponibili a richiesta LED 2700K o 4000K / On request 2700K or 4000K LED available

**01** bianco  
white

**02** nero  
black

**21** foglia oro  
gold leaf





Anello in alluminio con schermo inferiore in polycarbonato opale ad alta trasmittanza. Disponibile nelle versioni parete/soffitto e sospensione. Emissione di luce diretta attraverso modulo LED con dimmerazione DALI/Push DIM di serie su tutte le versioni. Anello rifinito con vernice poliaccrilica color bianco, nero, bronzo o decorato a mano con foglia oro. Possibili colori custom su richiesta. Versione a sospensione fornita con 3 cavi in acciaio regolabili in lunghezza (6 cavi per  $\varnothing$  180cm). Versioni a parete/soffitto fornite di kit di montaggio semplificato. Ideale per ambienti residenziali, grandi composizioni per uffici, strutture ricettive e spazi pubblici. Spedizione del prodotto in un pezzo unico già assemblato.

Aluminium ring with bottom high-transmittance screen in opal polycarbonate. Available in wall/ceiling and suspension versions. Emission of direct light provided by LED module with technology DALI/Push DIM on all versions. Ring eventually finished in polyacrilic paint white, black, bronze or hand-decorated in golden leaf. Custom colors are available on request. Suspended version supplied with 3 steel cable adjustable in length (6 cables for  $\varnothing$  180cm). The wall/ceiling version is supplied with a simplified mounting kit. Ideal for residential use, compositions for offices, hospitality facilities and public spaces. Delivery of the product in single piece already assembled.

## SILVER RING

	CODICE CODE	FONTI LUMINOSE LIGHT SOURCES	kg
	<b>L08201.050.0402</b> <b>L08202.050.0402</b> <b>L08217.050.0402</b> <b>L08221.050.0402</b>	Potenza assorbita apparecchio / Luminaire power consumption 25W Flusso luminoso apparecchio / Luminaire luminous flux 1809lm 3000K Ra>90 220-240V AC dimmable (DALI/Push DIM) IP40 85°	4,81
	<b>L08201.080.0402</b> <b>L08202.080.0402</b> <b>L08217.080.0402</b> <b>L08221.080.0402</b>	Potenza assorbita apparecchio / Luminaire power consumption 45W Flusso luminoso apparecchio / Luminaire luminous flux 3053lm 3000K Ra>90 220-240V AC dimmable (DALI/Push DIM) IP40 85°	8,74
	<b>L08201.120.0402</b> <b>L08202.120.0402</b> <b>L08217.120.0402</b> <b>L08221.120.0402</b>	Potenza assorbita apparecchio / Luminaire power consumption 75W Flusso luminoso apparecchio / Luminaire luminous flux 5233lm 3000K Ra>90 220-240V AC dimmable (DALI/Push DIM) IP40 85°	13,42
	<b>L08201.180.0402</b> <b>L08202.180.0402</b> <b>L08217.180.0402</b> <b>L08221.180.0402</b>	Potenza assorbita apparecchio / Luminaire power consumption 110W Flusso luminoso apparecchio / Luminaire luminous flux 7850lm 3000K Ra>90 220-240V AC dimmable (DALI/Push DIM) IP40 85°	21,31

# RING COLLECTION

Enzo Panzeri 2016

		CODICE CODE	FONTI LUMINOSE LIGHT SOURCES	kg
		<b>P08201.050.0402</b>	Potenza assorbita apparecchio / Luminaire power consumption 25W	4,90
		<b>P08202.050.0402</b>	Flusso luminoso apparecchio / Luminaire luminous flux 1809lm	
		<b>P08217.050.0402</b>	3000K Ra>90 220-240V AC dimmable (DALI/Push DIM)	
		<b>P08221.050.0402</b>	IP40 850°	
		<b>P08201.080.0402</b>	Potenza assorbita apparecchio / Luminaire power consumption 45W	7,63
		<b>P08202.080.0402</b>	Flusso luminoso apparecchio / Luminaire luminous flux 3053lm	
		<b>P08217.080.0402</b>	3000K Ra>90 220-240V AC dimmable (DALI/Push DIM)	
		<b>P08221.080.0402</b>	IP40 850°	
		<b>P08201.120.0402</b>	Potenza assorbita apparecchio / Luminaire power consumption 75W	11,63
		<b>P08202.120.0402</b>	Flusso luminoso apparecchio / Luminaire luminous flux 5233lm	
		<b>P08217.120.0402</b>	3000K Ra>90 220-240V AC dimmable (DALI/Push DIM)	
		<b>P08221.120.0402</b>	IP40 850°	
		<b>P08201.180.0402</b>	Potenza assorbita apparecchio / Luminaire power consumption 110W	18,86
		<b>P08202.180.0402</b>	Flusso luminoso apparecchio / Luminaire luminous flux 7850lm	
		<b>P08217.180.0402</b>	3000K Ra>90 220-240V AC dimmable (DALI/Push DIM)	
		<b>P08221.180.0402</b>	IP40 850°	



Fotometrie disponibili [www.panzeri.it](http://www.panzeri.it) / Photometric data available at [www.panzeri.it](http://www.panzeri.it)

CODICI COLORI DISPONIBILI / COLOUR CODES AVAILABLE

Disponibili a richiesta LED 2700K o 4000K / On request 2700K or 4000K LED available

- 01** bianco  
white
- 02** nero  
black
- 17** bronzo  
bronze
- 21** foglia oro  
gold leaf





Lampada a sospensione in alluminio tornito. Emissione indiretta attraverso COB LED con dimmerazione DALI/ Push DIM integrata. Disco rifinito con vernice poliacrilica color bianco, nero e decorata a mano con foglia oro. Possibili colori custom su richiesta. Ideale per hall, zone living, grandi spazi.

Suspension lamp in turned aluminium. Emission of indirect light provided by LED COB with integrated technology DALI/Push DIM. Fixture finished in polyacrylic paint white, black and hand-decorated in golden leaf. Custom colors are available on request. Ideal for halls, living, and public spaces.

CODICE CODE	FONTI LUMINOSE LIGHT SOURCES	kg
-------------	------------------------------	----



**L09301.060.0402**  
**L09302.060.0402**  
**L09321.060.0402**

Potenza assorbita apparecchio / Luminaire power consumption 43W  
 Flusso luminoso apparecchio / Luminaire luminous flux 4413lm  
 3000K Ra>90 220-240V AC dimmable (DALI/Push DIM)

3,46

IP20

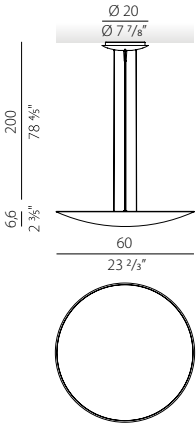

**L09301.100.0402**  
**L09302.100.0402**  
**L09321.100.0402**

Potenza assorbita apparecchio / Luminaire power consumption 88W  
 Flusso luminoso apparecchio / Luminaire luminous flux 8825lm  
 3000K Ra>90 220-240V AC dimmable (DALI/Push DIM)

7,35

IP20

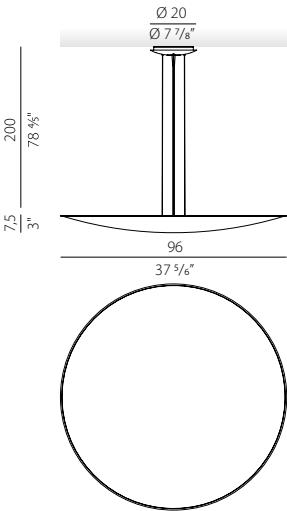

Fotometrie disponibili [www.panzeri.it](http://www.panzeri.it) / Photometric data available at [www.panzeri.it](http://www.panzeri.it)

**CODICI COLORI DISPONIBILI / COLOUR CODES AVAILABLE**

**01** bianco  
white

**02** nero  
black

**21** foglia oro  
gold leaf

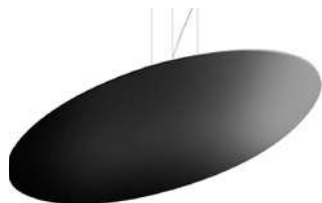





La gamma di lampade da parete della serie GONIO risponde ai più elevati standard di comfort visivo per l'illuminazione di ambienti di passaggio o di accoglienza quali corridoi, anticamere, hall di alberghi e uffici. Geometrie calibrate ne fanno un prodotto dalle forme essenziali ottimizzate per una perfetta distribuzione dei fasci luminosi verso l'alto e verso il basso, ottenuta grazie all'uso di lenti professionali con angolazioni studiate per evitare qualsiasi tipo di abbagliamento. Il corpo è realizzato in alluminio estruso con terminali di chiusura in pressofusione di alluminio, disponibile nelle finiture bianco, nero, bronzo, ottone satinato e titanio. È proposto in tre versioni di lunghezze differenti per maggiori possibilità applicative, completo di driver dimmerabile integrato per regolazione dell'intensità luminosa tramite dispositivi DALI o Push DIM.

GONIO is a range of wall mount sconces that respond to the most elevated standards of visual comfort for the illumination of pathways or hospitality areas, such as corridors, waiting rooms, halls and offices. Precise geometries and essential lines make GONIO a product optimized for a better distribution of light upwards and downwards, thanks to the use of professional lenses with angle degrees engineered to avoid any kind of glaring. The body of the lamp is built in extruded aluminum with end caps in aluminum die-cast, available in white, black, bronze, mat brass and titanium finishes. It is offered in three versions with different lengths for greater application settings, complete with integrated dimmable driver for regulating the light intensity through DALI or Push DIM devices.

	CODICE CODE	FONTI LUMINOSE LIGHT SOURCES	kg
	<b>A01901.030.0502</b>	Potenza assorbita apparecchio / Luminaire power consumption 24W	1,08
	<b>A01902.030.0502</b>	Flusso luminoso apparecchio / Luminaire luminous flux 2168lm	
	<b>A01917.030.0502</b>	2700K Ra>90 220-240V AC dimmable (DALI/Push DIM)	
	<b>A01919.030.0502</b>	IP40	
	<b>A01901.030.0402</b>	Potenza assorbita apparecchio / Luminaire power consumption 24W	1,08
	<b>A01902.030.0402</b>	Flusso luminoso apparecchio / Luminaire luminous flux 2252lm	
	<b>A01917.030.0402</b>	3000K Ra>90 220-240V AC dimmable (DALI/Push DIM)	
	<b>A01919.030.0402</b>	IP40	
	<b>A01901.045.0502</b>	Potenza assorbita apparecchio / Luminaire power consumption 35W	1,37
	<b>A01902.045.0502</b>	Flusso luminoso apparecchio / Luminaire luminous flux 3252lm	
	<b>A01917.045.0502</b>	2700K Ra>90 220-240V AC dimmable (DALI/Push DIM)	
	<b>A01930.045.0502</b>	IP40	
	<b>A01901.045.0402</b>	Potenza assorbita apparecchio / Luminaire power consumption 35W	1,37
	<b>A01902.045.0402</b>	Flusso luminoso apparecchio / Luminaire luminous flux 3378lm	
	<b>A01917.045.0402</b>	3000K Ra>90 220-240V AC dimmable (DALI/Push DIM)	
	<b>A01930.045.0402</b>	IP40	
	<b>A01901.060.0502</b>	Potenza assorbita apparecchio / Luminaire power consumption 45W	2,05
	<b>A01902.060.0502</b>	Flusso luminoso apparecchio / Luminaire luminous flux 4337lm	
	<b>A01917.060.0502</b>	2700K Ra>90 220-240V AC dimmable (DALI/Push DIM)	
	<b>A01930.060.0502</b>	IP40	
	<b>A01901.060.0402</b>	Potenza assorbita apparecchio / Luminaire power consumption 45W	2,05
	<b>A01902.060.0402</b>	Flusso luminoso apparecchio / Luminaire luminous flux 4503lm	
	<b>A01917.060.0402</b>	3000K Ra>90 220-240V AC dimmable (DALI/Push DIM)	
	<b>A01930.060.0402</b>	IP40	

Fotometrie disponibili [www.panzeri.it](http://www.panzeri.it) / Photometric data available at [www.panzeri.it](http://www.panzeri.it)

Disponibili a richiesta con lente 100° / 100° lens version available on request

### CODICI COLORI DISPONIBILI / COLOUR CODES AVAILABLE

**01** bianco  
white

**02** nero  
black

**17** bronzo  
bronze

**19** ottone satinato  
mat brass



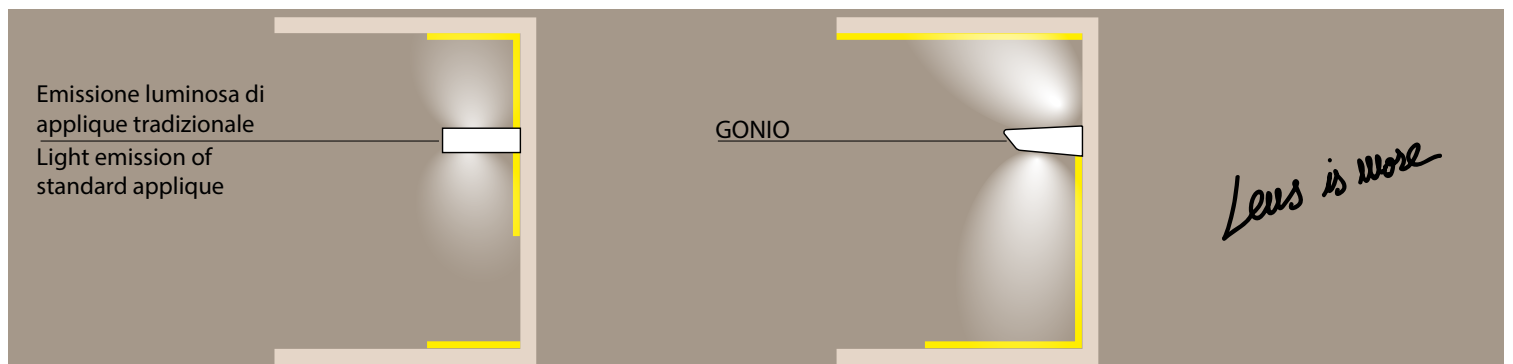



**30** titanio  
titanium





Un corpo illuminante costituito dalla combinazione di elementi lineari trasversali e longitudinali, in grado di caratterizzare con le sue infinite possibilità compositive la scenografia di ogni ambiente. Le numerose varianti consentono un'installazione libera e intuitiva sia a sospensione che a soffitto o parete. La doppia emissione costituisce un ulteriore fattore di versatilità: nella versione a sospensione infatti è possibile invertire l'orientamento delle funi, permettendo l'installazione del prodotto su entrambe le facce per una maggiore illuminazione diretta o indiretta. I modelli a sospensione sono inoltre abbinabili agli articoli To-Be 22, per uno sviluppo tridimensionale delle composizioni. Disponibile nelle finiture bianco, nero satinato, bronzo, ottone satinato e titanio, con diffusori opalini o neri.

A lighting fitting made of a combination of linear longitudinal elements, enabling to characterize every interior space with its endless configuration possibilities. The many variants allow a free and intuitive installation, suspended or surface mounted on ceiling or wall. The double emission provides an additional versatility factor: the suspended version allows to invert the hanging steel cables, enabling the installation of the product on both sides for an illumination with majority of light downwards or upwards. Furthermore, the suspension models can be combined with To-Be 22, for a tridimensional construction of the product layout. Available in finishes white, satin black, bronze, mat brass, titanium, with white opal diffuser or black diffuser.

CODICE CODE	FONTI LUMINOSE LIGHT SOURCES	kg
 <b>L02801.115.0502</b>	Potenza assorbita apparecchio / Luminaire power consumption 80W	2,80
 <b>L02806.115.0502</b>	Flusso luminoso apparecchio / Luminaire luminous flux 5045lm	
<b>L02817.115.0502</b>	2700K Ra>90 220-240V AC dimmable (DALI/Push DIM)	
<b>L02819.115.0502</b>	 IP20	
<b>L02830.115.0502</b>	Diffusori opali Opal diffusers	
 <b>L02901.115.0502</b>	Potenza assorbita apparecchio / Luminaire power consumption 80W	2,80
 <b>L02906.115.0502</b>	Flusso luminoso apparecchio / Luminaire luminous flux 2118lm	
<b>L02917.115.0502</b>	2700K Ra>90 220-240V AC dimmable (DALI/Push DIM)	
<b>L02919.115.0502</b>	 IP20	
<b>L02930.115.0502</b>	Diffusori neri Black diffusers	

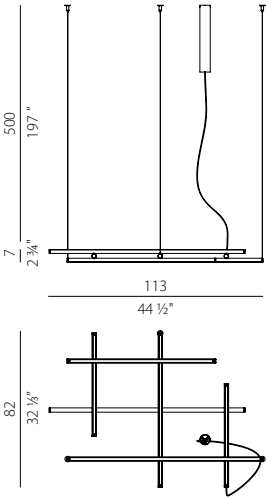

### ORIENTAMENTI D'INSTALLAZIONE / INSTALLATION LAYOUTS

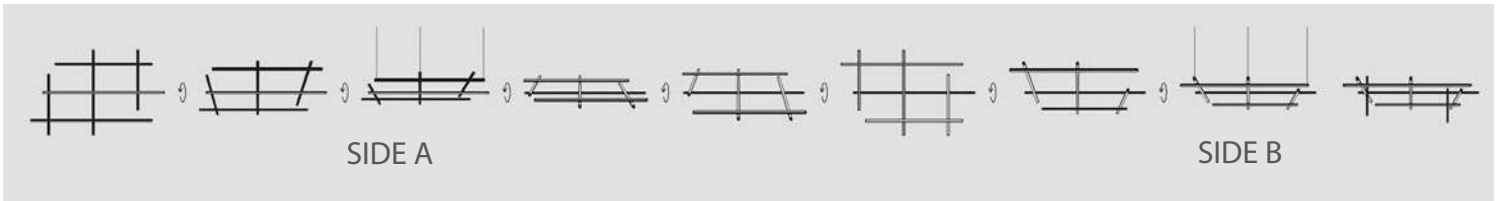

### ESEMPI D'INSTALLAZIONE / INSTALLATION EXAMPLES

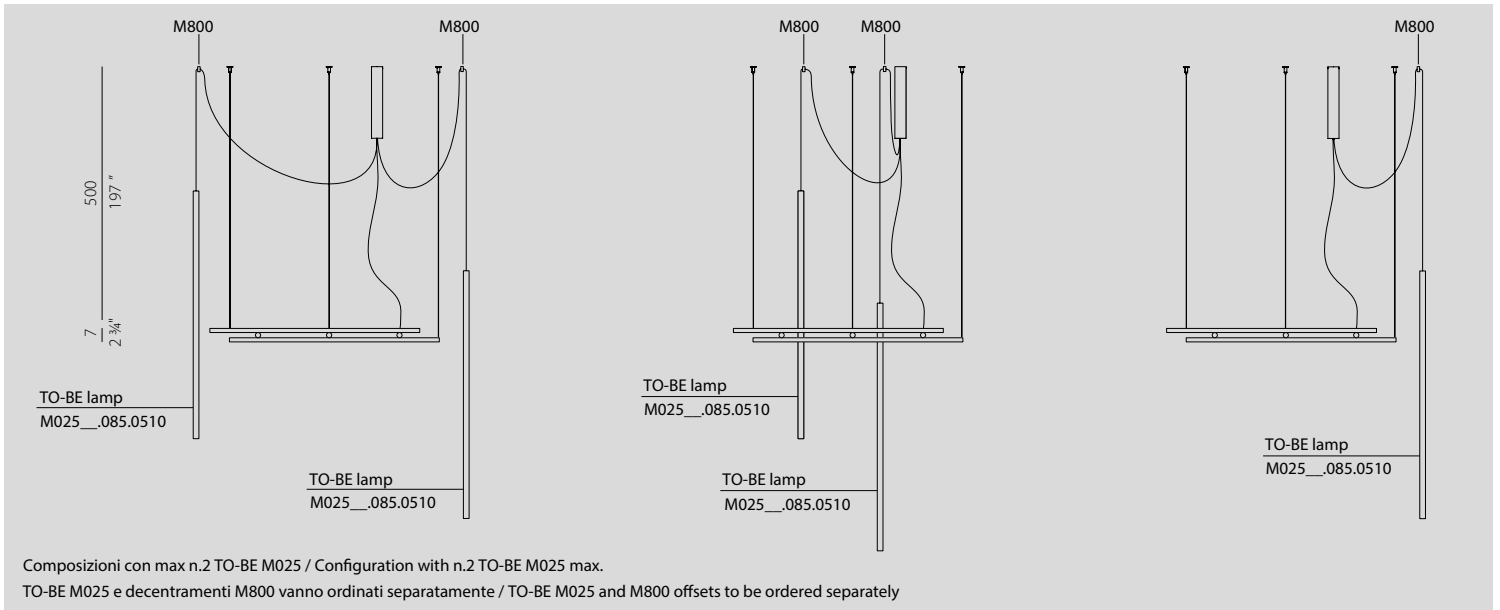

Composizioni con max n.2 TO-BE M025 / Configuration with n.2 TO-BE M025 max.

TO-BE M025 e decentramenti M800 vanno ordinati separatamente / TO-BE M025 and M800 offsets to be ordered separately

	CODICE CODE	FONTI LUMINOSE LIGHT SOURCES	kg
	<b>P02801.115.0502</b> <b>P02806.115.0502</b> <b>P02817.115.0502</b> <b>P02819.115.0502</b> <b>P02830.115.0502</b>	Potenza assorbita apparecchio / Luminaire power consumption 78W Flusso luminoso apparecchio / Luminaire luminous flux 4602lm 2700K Ra>90 220-240V AC dimmable (DALI/Push DIM) LED IP20 Diffusori opali Opal diffusers	2,97
	<b>P02901.115.0502</b> <b>P02906.115.0502</b> <b>P02917.115.0502</b> <b>P02919.115.0502</b> <b>P02930.115.0502</b>	Potenza assorbita apparecchio / Luminaire power consumption 78W Flusso luminoso apparecchio / Luminaire luminous flux 2356lm 2700K Ra>90 220-240V AC dimmable (DALI/Push DIM) LED IP20 Diffusori neri Black diffusers	2,97
	<b>P02801.115.0510</b> <b>P02806.115.0510</b> <b>P02817.115.0510</b> <b>P02819.115.0510</b> <b>P02830.115.0510</b>	Potenza assorbita apparecchio / Luminaire power consumption 72W Flusso luminoso apparecchio / Luminaire luminous flux 4897lm 2700K Ra>90 24V DC LED IP20 ⬢ Diffusori opali, driver non incluso Opal diffusers, driver not included	2,15
	<b>P02901.115.0510</b> <b>P02906.115.0510</b> <b>P02917.115.0510</b> <b>P02919.115.0510</b> <b>P02930.115.0510</b>	Potenza assorbita apparecchio / Luminaire power consumption 72W Flusso luminoso apparecchio / Luminaire luminous flux 2651lm 2700K Ra>90 24V DC LED IP20 ⬢ Diffusori neri, driver non incluso Black diffusers, driver not included	2,15
	<b>A02901.115.0502</b> <b>A02906.115.0502</b> <b>A02917.115.0502</b> <b>A02919.115.0502</b> <b>A02930.115.0502</b>	Potenza assorbita apparecchio / Luminaire power consumption 77W Flusso luminoso apparecchio / Luminaire luminous flux 3812lm 2700K Ra>90 220-240V AC dimmable (DALI/Push DIM) LED IP20 Diffusore frontale nero Black front diffuser	2,97
	<b>A02901.115.0510</b> <b>A02906.115.0510</b> <b>A02917.115.0510</b> <b>A02919.115.0510</b> <b>A02930.115.0510</b>	Potenza assorbita apparecchio / Luminaire power consumption 71W Flusso luminoso apparecchio / Luminaire luminous flux 4088lm 2700K Ra>90 24V DC LED IP20 ⬢ Diffusore frontale nero, driver non incluso Black front diffuser, driver not included	2,15

Fotometrie disponibili [www.panzeri.it](http://www.panzeri.it) / Photometric data available at [www.panzeri.it](http://www.panzeri.it)

CODICI COLORI DISPONIBILI / COLOUR CODES AVAILABLE

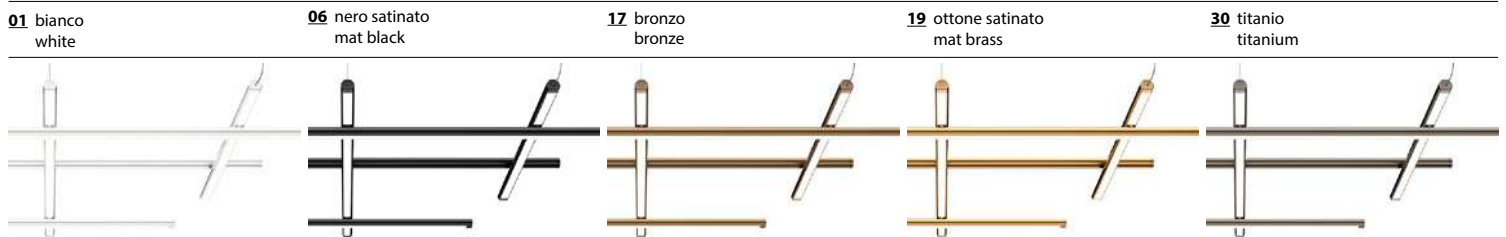

**BIGSEE  
PRODUCTDESIGN  
AWARD 2021  
WINNER**





Dall'esperienza di Hilow nasce la serie che rappresenta il principio fondante del sistema nella sua forma più elementare: un modulo lineare sottile e discreto anche nell'emissione di luce; un'asta luminosa applicabile a muro o per installazione libera a pavimento, con struttura in alluminio estruso e schermo rivolto verso la parete per un gradevole effetto di luce indiretta e soffusa. L'intensità di luce può essere ridotta sia nei modelli da parete, grazie al driver integrato regolabile tramite tecnologia DALI o Push DIM, che nelle piantane, dotate di cavo con pedale di regolazione. Versioni a parete disponibili nelle finiture bianco, nero satinato, bronzo, ottone satinato e titanio; nero satinato, bronzo e ottone satinato per quella a pavimento con basamento in marmo nero marquina. Piantana con basamento in travertine o in marmo verde alpi fornita in abbinamento alle colorazioni bronzo, ottone satinato e bianco soft materico.

From the success of Hilow, this new series represents the founding principle of the system in its purest form: a linear module slender and discreet also in the light emission; a luminous stick to install on the wall or free-standing on the floor, with a structure in extruded aluminum and diffuser directed towards the wall for a comfortable indirect light effect. The intensity of light can be dimmed both in the wall mount version, thanks to the integrated driver through DALI or Push DIM technology, and in the floor version, equipped with electrical cable with dimming pedal. Wall-mount versions are available in white, satin black, bronze, mat brass and titanium finishes; satin black, bronze and mat brass for the floor version with base in black marquina marble. Floor versions with base in travertine and "verde alpi" is paired with satin black, bronze and mat brass finishes.

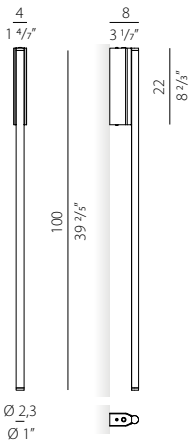
CODICE CODE	FONTI LUMINOSE LIGHT SOURCES	kg
-------------	------------------------------	----



-  **A11001.100.0502**
- A11006.100.0502**
- A11017.100.0502**
- A11019.100.0502**
- A11030.100.0502**

Potenza assorbita apparecchio / Luminaire power consumption 17W  
 Flusso luminoso apparecchio / Luminaire luminous flux 1018lm  
 2700K Ra>90 220-240V AC dimmable (DALI/Push DIM)  
 IP20

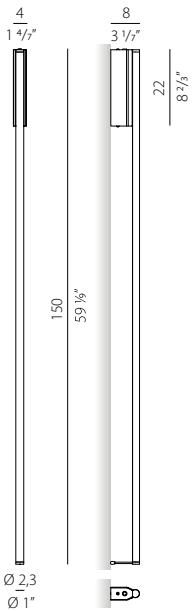

-  **A11001.150.0502**
- A11006.150.0502**
- A11017.150.0502**
- A11019.150.0502**
- A11030.150.0502**

Potenza assorbita apparecchio / Luminaire power consumption 27W  
 Flusso luminoso apparecchio / Luminaire luminous flux 1696lm  
 2700K Ra>90 220-240V AC dimmable (DALI/Push DIM)  
 IP20

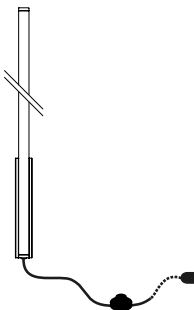

**YC11002.400** Cavo di alimentazione di lunghezza 4m (157,5") con interruttore a pedale e spina. 0,26  
 4m (157,5") long power cable with foot switch and plug.  
 Accessorio per Hilow Line A110  
 Accessory for Hilow Line A110



# HILOW LINE

Matteo Thun e Benedetto Fasciana 2021

	CODICE CODE	FONTI LUMINOSE LIGHT SOURCES	kg
	<b>T10706.200.0522</b> <b>T10717.200.0522</b> <b>T10719.200.0522</b>	Potenza assorbita apparecchio / Luminaire power consumption 39W Flusso luminoso apparecchio / Luminaire luminous flux 2714lm 2700K Ra>90 220-240V AC dimmer on cable <b>IP20</b>	10,01
		Base di appoggio in marmo verde alpi Bearing base in "verde alpi" marble	
	<b>T10817.200.0522</b> <b>T10819.200.0522</b> <b>T10828.200.0522</b>	Potenza assorbita apparecchio / Luminaire power consumption 39W Flusso luminoso apparecchio / Luminaire luminous flux 2714lm 2700K Ra>90 220-240V AC dimmer on cable <b>IP20</b>	9,44
		Base di appoggio in travertino Bearing base in travertine	
	<b>T10906.200.0522</b> <b>T10917.200.0522</b> <b>T10919.200.0522</b>	Potenza assorbita apparecchio / Luminaire power consumption 39W Flusso luminoso apparecchio / Luminaire luminous flux 2714lm 2700K Ra>90 220-240V AC dimmer on cable <b>IP20</b>	10,01
		Base di appoggio in marmo nero marquina Bearing base in black marquina marble	

Fotometrie disponibili [www.panzeri.it](http://www.panzeri.it) / Photometric data available at [www.panzeri.it](http://www.panzeri.it)

## CODICI COLORI DISPONIBILI / COLOUR CODES AVAILABLE

**01** bianco white     
 **06** nero satinato mat black     
 **17** bronzo bronze     
 **19** ottone satinato mat brass     
 **28** bianco soft materico textured soft white     
 **30** titanio titanium     
 **02** nero black





Lampada da tavolo, terra o parete/soffitto costituita da estruso in alluminio per la struttura e pressofusione di alluminio per la testa e lo snodo. Diffusore in policarbonato con perimetro luminoso e doppia serigrafia appositamente studiata per ottimizzare il fascio luminoso e ridurre l'abbagliamento. Fascio luminoso orientabile e dimmerabile per tutte le versioni (tranne versione P) con tecnologia Step DIM a 5 regolazioni di intensità luminosa e luce di cortesia. Struttura rifinita con vernice poliacrilica in bianco, nero, ottone satinato o spazzolato e verniciato colore titanio. Testa rotante su 2 assi grazie a un doppio snodo, disponibile con sensore di presenza. Miniaturizzazione del giunto a snodo con possibilità di regolarne la tenuta. Disponibili accessori nella versione C: morsetto, perno e braccio parete. Ideale per uffici, scrivanie, studi, zone notte.

Table, floor or wall/ceiling lamp made of extruded aluminium for the structure and die-cast aluminium for the head and the junction. Diffuser in polycarbonate with luminous perimeter and double screen serigraphy, specifically designed to optimize the beam and reduce the glare. Swiveling light beam and dimmable for all versions (except for version P) with technology Step DIM with 5 intensity of light settings and courtesy light. Structure in white, black or mat brass polyacrylic paint, or brushed and colored titanium. Rotating head on 2-axis through a double joint. Miniaturization of the junction with the possibility of regulating the tightness, presence detector available. Accessories available in the C version: clamp, pin and the wall arm. Ideal for offices, desks, studios, night zones.

	CODICE CODE	FONTI LUMINOSE LIGHT SOURCES	kg
<b>NEW</b> 	<b>C07701.000.0409</b>	Potenza assorbita apparecchio / Luminaire power consumption 10W	4,10
	<b>C07702.000.0409</b>	Flusso luminoso apparecchio / Luminaire luminous flux 706lm	
	<b>C07719.000.0409</b>	3000K Ra>90 90° 220-240V AC dimmable (Step DIM)	
	<b>C07730.000.0409</b>	<b>IP40</b>	
	<b>C07701.000.0409P</b>	Potenza assorbita apparecchio / Luminaire power consumption 10W	
<b>C07702.000.0409P</b>	Flusso luminoso apparecchio / Luminaire luminous flux 706lm		
<b>C07719.000.0409P</b>	3000K Ra>90 90° 220-240V AC dimmable (Step DIM)		
<b>C07730.000.0409P</b>	<b>IP40</b>		
		Versione con sensore di presenza Presence detector version	
	<b>CM07701.000.0409</b>	Potenza assorbita apparecchio / Luminaire power consumption 10W	0,83
	<b>CM07702.000.0409</b>	Flusso luminoso apparecchio / Luminaire luminous flux 706lm	
	<b>CM07730.000.0409</b>	3000K Ra>90 90° 220-240V AC dimmable (Step DIM)	
	<b>IP40</b>		
	<b>CP07701.000.0409</b>	Potenza assorbita apparecchio / Luminaire power consumption 10W	0,63
	<b>CP07702.000.0409</b>	Flusso luminoso apparecchio / Luminaire luminous flux 706lm	
	<b>CP07730.000.0409</b>	3000K Ra>90 90° 220-240V AC dimmable (Step DIM)	
	<b>IP40</b>		
	<b>CA07701.000.0409</b>	Potenza assorbita apparecchio / Luminaire power consumption 10W	0,84
	<b>CA07702.000.0409</b>	Flusso luminoso apparecchio / Luminaire luminous flux 706lm	
	<b>CA07730.000.0409</b>	3000K Ra>90 90° 220-240V AC dimmable (Step DIM)	
	<b>IP40</b>		

# JACKIE

Enzo Panzeri 2015

Registered Design

	CODICE CODE	FONTI LUMINOSE LIGHT SOURCES	kg
	<b>T07701.000.0409</b>	Potenza assorbita apparecchio / Luminaire power consumption 10W	5,21
	<b>T07702.000.0409</b>	Flusso luminoso apparecchio / Luminaire luminous flux 706lm	
	<b>T07730.000.0409</b>	3000K Ra>90 90° 220-240V AC dimmable (Step DIM)	
		<b>IP40</b>	

	<b>A07701.000.0409</b>	Potenza assorbita apparecchio / Luminaire power consumption 10W	0,47
	<b>A07702.000.0409</b>	Flusso luminoso apparecchio / Luminaire luminous flux 706lm	
	<b>A07730.000.0409</b>	3000K Ra>90 90° 220-240V AC dimmable (Step DIM)	
		<b>IP40</b>	

	<b>P07701.000.0101</b>	Potenza assorbita apparecchio / Luminaire power consumption 8,5W	0,46
	<b>P07702.000.0101</b>	Flusso luminoso apparecchio / Luminaire luminous flux 820lm	
	<b>P07730.000.0101</b>	3000K Ra>80 90° 220-240V AC ON-OFF	
		<b>IP40</b>	



Fotometrie disponibili [www.panzeri.it](http://www.panzeri.it) / Photometric data available at [www.panzeri.it](http://www.panzeri.it)

## CODICI COLORI DISPONIBILI / COLOUR CODES AVAILABLE

<b>01</b> bianco white	<b>02</b> nero black	<b>19</b> ottone satinato mat brass	<b>30</b> titanio titanium
---------------------------	-------------------------	--	-------------------------------





Applique per camere da letto con luce indiretta soffusa e luce da lettura orientabile, in tonalità bianco caldo. È disponibile in due versioni speculari per il posizionamento sul lato sinistro e destro del letto, provvista di una mensola con presa elettrica per la ricarica di piccoli dispositivi USB quali telefoni cellulari. Completa di driver ON-OFF integrati, è fornita con doppio interruttore per accensione separata dell'illuminazione di cortesia e della luce da lettura. I modelli sono disponibili nelle finiture bianco, nero, bronzo, ottone satinato e titanio.

Wall mount fitting for bedrooms with indirect diffused light and adjustable reading light, in warm white. Available in two mirrored version for positioning on left-hand side and right-hand side of the bed, it showcases a shelf with a USB power outlet for charging batteries of electronic devices such as smartphones. Supplied with integrated ON-OFF drivers, it showcases a double switch for separate control of the courtesy light and the reading light. Available in finishes white, black, bronze, mat brass, titanium.

	CODICE CODE	FONTI LUMINOSE LIGHT SOURCES	kg
	<b>A13501.033.0501</b>	Potenza assorbita apparecchio / Luminaire power consumption 18W	1,25
	<b>A13502.033.0501</b>	Flusso luminoso apparecchio / Luminaire luminous flux 392lm + 405lm2700K	
	<b>A13517.033.0501</b>	Ra>90 34° 220-240V AC ON-OFF	
	<b>A13519.033.0501</b>	<b>IP20</b>	
	<b>A13530.033.0501</b>	Versione sinistra Completo di interruttori per doppia accensione e porta USB per ricarica strumenti elettronici Left version With double switch and USB port for electronic devices charging	
	<b>A13601.033.0501</b>	Potenza assorbita apparecchio / Luminaire power consumption 18W	1,25
	<b>A13602.033.0501</b>	Flusso luminoso apparecchio / Luminaire luminous flux 392lm + 405lm	
	<b>A13617.033.0501</b>	2700K Ra>90 34° 220-240V AC ON-OFF	
	<b>A13619.033.0501</b>	<b>IP20</b>	
	<b>A13630.033.0501</b>	Versione destra Completo di interruttori per doppia accensione e porta USB per ricarica strumenti elettronici Right version With double switch and USB port for electronic devices charging	

Fotometrie disponibili [www.panzeri.it](http://www.panzeri.it) / Photometric data available at [www.panzeri.it](http://www.panzeri.it)

#### CODICI COLORI DISPONIBILI / COLOUR CODES AVAILABLE

- |                           |                         |                            |  |                               |
|---------------------------|-------------------------|----------------------------|--|-------------------------------|
| <b>01</b> bianco<br>white | <b>02</b> nero<br>black | <b>17</b> bronzo<br>bronze | <b>19</b> ottone satinato<br>mat brass | <b>30</b> titanio<br>titanium |
|---------------------------|-------------------------|----------------------------|--|-------------------------------|







Lola è sinonimo di versatilità: un design, molteplici applicazioni, per offrire soluzioni illuminotecniche personalizzate e flessibili, ideali per ogni esigenza progettuale. Si inserisce facilmente in numerosi contesti, dal retail, all'hospitality, al residenziale grazie al suo design caratterizzato da linee compatte, all'elegante forma cilindrica della testa e alla possibilità di orientamento del fascio luminoso. Il modello con base si applica a soffitto o parete, mentre la versione con rosone ad incasso è studiata appositamente per locali con controsoffitti. Le ottiche arretrate e lo snoot di serie consentono di ridurre l'abbagliamento al minimo. Disponibile nelle finiture bianco, nero, bronzo, ottone satinato e titanio. Tutte le versioni sono fornite complete di driver.

Lola is synonym of versatility: one design, multiple applications, to offer personalized and flexible lighting solution, ideal for every interior design need. It can be used in a number of project environments, from retail to hospitality to residential, thanks to its design characterized by compact lines, the elegant cylindrical form of the head and the possibility of adjusting the light direction. The version with the base can be installed on the ceiling or wall, whereas the version with the recessed canopy is engineered specifically for rooms with drywall false ceiling. The recessed lense and the snoot allow to minimize the glaring. Available in finishes white, black, bronze, mat brass and titanium. All versions are provided complete with power supply.

	CODICE CODE	FONTI LUMINOSE LIGHT SOURCES	kg
	<b>P12001.020.2504</b>	Potenza assorbita apparecchio / Luminaire power consumption 9W	0,60
	<b>P12002.020.2504</b>	Flusso luminoso apparecchio / Luminaire luminous flux 972lm	
	<b>P12017.020.2504</b>	3000K Ra>90 24° 220-240V AC dimmable (phase cut)	
	<b>P12019.020.2504</b>	IP20 850°	
	<b>P12030.020.2504</b>	Diametro consigliato del corrugato max 20mm Recommended corrugated pipe diameter max 20mm	
	<b>X12001.020.4002</b>	Potenza assorbita apparecchio / Luminaire power consumption 18W	0,52
	<b>X12002.020.4002</b>	Flusso luminoso apparecchio / Luminaire luminous flux 1995lm	
	<b>X12017.020.4002</b>	3000K Ra>85 24° 500mA DC dimmable (DALI/Push DIM)	
	<b>X12019.020.4002</b>	IP20 850°	
	<b>X12030.020.4002</b>	Fornito completo di driver DALI/Push DIM Supplied with DALI/Push DIM driver	

Fotometrie disponibili [www.panzeri.it](http://www.panzeri.it) / Photometric data available at [www.panzeri.it](http://www.panzeri.it)

UGR < 12 in funzione delle condizioni di installazione / UGR < 12 depending on installation conditions

CODICI COLORI DISPONIBILI / COLOUR CODES AVAILABLE

Disponibili a richiesta LED 2700K / On request 2700K LED available

- 01** bianco  
white
- 02** nero  
black
- 17** bronzo  
bronze
- 19** ottone satinato  
mat brass
- 30** titanio  
titanium





La tradizione nella lavorazione a mano del vetro soffiato dà vita alla famiglia Murané, una serie di corpi illuminanti installabili a sospensione sia come elementi singoli che secondo composizioni personalizzate, oppure applicabili a soffitto e parete, in appoggio o parzialmente incassati. Il diffusore sferico in vetro in diverse finiture è lavorato internamente, con un effetto ondulato di grande impatto decorativo. La sorgente LED di piccole dimensioni è mascherata da un'apposita copertura in policarbonato, che contribuisce a una diffusione ottimale del fascio luminoso. Le versioni a sospensione sono disponibili con rosone oppure per l'abbinamento con rosoni per sospensioni multiple o a scomparsa.

The tradition in the hand-made craftsmanship of blown glass gives birth to Murané, a series of fittings to install as individual suspensions or customized clusters, on surface or as partially recessed wall-ceiling mount fitting. The spherical diffuser in transparent, in different colours, glass is hand-crafted with a wavy effect of great decorative effect. The LED source is minimal and hidden in a polycarbonate cover, that ensures an optimal light diffusion. The suspension versions are available with individual canopy or without, in order to be combined with recessed or cluster canopies.

NEW

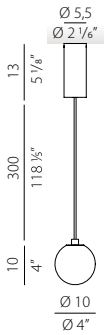

CODICE CODE	FONTI LUMINOSE LIGHT SOURCES	kg
L11505.010.0501	vetro bronzo / bronze glass	0,78
L11506.010.0501		
L11705.010.0501	vetro cristallo trasparente / transparent crystal glass	
L11706.010.0501		
L11805.010.0501	vetro cristallo fumè / smoke grey crystal glass	
L11806.010.0501		
L11905.010.0501	vetro verde foresta / green forest glass	
L11906.010.0501		
Potenza assorbita apparecchio / Luminaire power consumption 4W Flusso luminoso apparecchio / Luminaire luminous flux 167lm 2700K Ra>90 2 20-240V AC ON-OFF		
IP20		

NEW

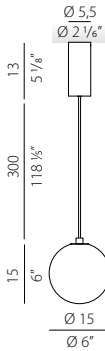

L11505.015.0501	vetro bronzo / bronze glass	1,12
L11506.015.0501		
L11705.015.0501	vetro cristallo trasparente / transparent crystal glass	
L11706.015.0501		
L11805.015.0501	vetro cristallo fumè / smoke grey crystal glass	
L11806.015.0501		
L11905.015.0501	vetro verde foresta / green forest glass	
L11906.015.0501		
Potenza assorbita apparecchio / Luminaire power consumption 4W Flusso luminoso apparecchio / Luminaire luminous flux 167lm 2700K Ra>90 220-240V AC ON-OFF		
IP20		

NEW

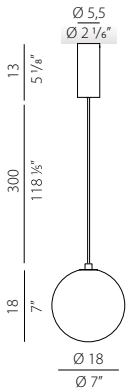

L11505.018.0501	vetro bronzo / bronze glass	1,48
L11506.018.0501		
L11705.018.0501	vetro cristallo trasparente / transparent crystal glass	
L11706.018.0501		
L11805.018.0501	vetro cristallo fumè / smoke grey crystal glass	
L11806.018.0501		
L11905.018.0501	vetro verde foresta / green forest glass	
L11906.018.0501		
Potenza assorbita apparecchio / Luminaire power consumption 4W Flusso luminoso apparecchio / Luminaire luminous flux 167lm 2700K Ra>90 220-240V AC ON-OFF		
IP20		

	CODICE CODE	FONTI LUMINOSE LIGHT SOURCES	kg
<b>NEW</b> 	<b>M11505.010.0510</b>	vetro bronzo / bronze glass	0,53
	<b>M11705.010.0510</b>	vetro cristallo trasparente / transparent crystal glass	
	<b>M11805.010.0510</b>	vetro cristallo fumè / smoke grey crystal glass	
	<b>M11905.010.0510</b>	vetro verde foresta / green forest glass	
<b>NEW</b> 	<b>M11505.015.0510</b>	vetro bronzo / bronze glass	0,87
	<b>M11705.015.0510</b>	vetro cristallo trasparente / transparent crystal glass	
	<b>M11805.015.0510</b>	vetro cristallo fumè / smoke grey crystal glass	
	<b>M11905.015.0510</b>	vetro verde foresta / green forest glass	
<b>NEW</b> 	<b>M11505.018.0510</b>	vetro bronzo / bronze glass	1,23
	<b>M11705.018.0510</b>	vetro cristallo trasparente / transparent crystal glass	
	<b>M11805.018.0510</b>	vetro cristallo fumè / smoke grey crystal glass	
	<b>M11905.018.0510</b>	vetro verde foresta / green forest glass	
	<b>P11505.010.0501</b>	Potenza assorbita apparecchio / Luminaire power consumption 4W Flusso luminoso apparecchio / Luminaire luminous flux 167lm 2700K Ra>90 220-240V AC ON-OFF	0,42
	<b>IP20</b>	Fornito completo di driver ON-OFF integrato Supplied with built-in ON-OFF driver	
	<b>X11505.010.0501</b>	Potenza assorbita apparecchio / Luminaire power consumption 4W Flusso luminoso apparecchio / Luminaire luminous flux 167lm 2700K Ra>90 24V DC ON-OFF	0,42
	<b>IP20</b>	Fornito completo di driver ON-OFF Supplied with ON-OFF driver	

Fotometrie disponibili [www.panzeri.it](http://www.panzeri.it) / Photometric data available at [www.panzeri.it](http://www.panzeri.it)

## CODICI COLORI DISPONIBILI / COLOUR CODES AVAILABLE

**05** champagne  
champagne

**06** nero satinato  
mat black

## COLORE VETRI / GLASSES COLOUR

**115** bronzo  
bronze

**117** cristallo trasparente  
transparent crystal

**118** cristallo fumè  
smoke grey crystal

**119** verde foresta  
green forest







Estensione della famiglia Murané articolata in composizioni di sfere luminose disposte a corona. Gli anelli sono proposti in due formati, con diametro esterno 80cm o 110cm, e possono a loro volta essere combinati per creare delle sovrapposizioni verticali di più elementi. Struttura portante in alluminio estruso disponibile nelle finiture champagne e nero satinato. Corona di diffusori sferici in vetro soffiato color bronzo trasparente. Accessori di alimentazione e fissaggio da ordinare separatamente, che comprendono rosone, cavo di alimentazione e funi con dispositivi di ancoraggio al soffitto. Per la sovrapposizione di più elementi è obbligatorio ordinare l'apposito accessorio di alimentazione e fissaggio aggiuntivo. Possibilità di realizzare composizioni custom con un numero maggiore di anelli.

Extension of the series Murané made of circular compositions of luminous spheres. The rings are available in two dimensions, with external diameter 80cm or 110cm, and they allow to create vertical configurations of multiple suspensions. The ring is made of extruded aluminum in champagne or satin black finishing. Spherical diffusers in transparent bronze blown glass. Accessories for power supply and hanging to be ordered separately, and include canopy, power cable, steel ropes with devices for ceiling fixing. For laying out more elements it is mandatory to order the additional accessory including power cable and steel ropes. Possibility to realize custom compositions with an increased number of rings.

	CODICE CODE	FONTI LUMINOSE LIGHT SOURCES	kg
	<b>M11605.080.0510</b> <b>M11606.080.0510</b>	Potenza assorbita apparecchio / Luminaire power consumption 48W Flusso luminoso apparecchio / Luminaire luminous flux 2647lm 2700K Ra>90 24V DC <b>IP20</b>	8,19
		Fornito senza kit di sospensione, cavo di alimentazione, rosone e driver, per composizioni singole o multiple Supplied without suspension kit, power cable, canopy and driver, for single or multiple configurations	

	<b>M11605.110.0510</b> <b>M11606.110.0510</b>	Potenza assorbita apparecchio / Luminaire power consumption 66W Flusso luminoso apparecchio / Luminaire luminous flux 3677lm 2700K Ra>90 24V DC <b>IP20</b>	10,30
		Fornito senza kit di sospensione, cavo di alimentazione, rosone e driver, per composizioni singole o multiple Supplied without suspension kit, power cable, canopy and driver, for single or multiple configurations	



# MURANÉ

Matteo Thun e Benedetto Fasciana 2022

	CODICE CODE	FONTI LUMINOSE LIGHT SOURCES	kg
<p><b>NEW</b></p>	<b>M10605.110.0510</b>	<p>Potenza assorbita apparecchio / Luminaire power consumption 21W Flusso luminoso apparecchio / Luminaire luminous flux 1177lm 2700K Ra&gt;90 24V DC</p> <p><b>LED IP20</b></p> <p>Fornito senza kit di sospensione, cavo di alimentazione, rosone e driver, per composizioni singole o multiple Supplied without suspension kit, power cable, canopy and driver, for single or multiple configurations</p>	

<p><b>NEW</b></p>	<b>M10605.140.0510</b>	<p>Potenza assorbita apparecchio / Luminaire power consumption 32W Flusso luminoso apparecchio / Luminaire luminous flux 1765lm 2700K Ra&gt;90 24V DC</p> <p><b>LED IP20</b></p> <p>Fornito senza kit di sospensione, cavo di alimentazione, rosone e driver, per composizioni singole o multiple Supplied without suspension kit, power cable, canopy and driver, for single or multiple configurations</p>	
-------------------	------------------------	--	--

## COMPOSIZIONI MURANÉ R - MURANÉ R CONFIGURATIONS

COMPOSIZIONI / CONFIGURATIONS	KIT ALIMENTAZIONE E SOSPENSIONE FEEDING AND SUSPENSION KIT YFR116_.075.A02	KIT ALIMENTAZIONE E SOSPENSIONE FEEDING AND SUSPENSION KIT YFR116_.180.A02	KIT SOSPENSIONE PER DIMENSIONI UGUALI SUSPENSION KIT FOR SAME DIMENSIONS YFA11600.010	KIT SOSPENSIONE PER DIMENSIONI DIFFERENTI SUSPENSION KIT FOR DIFFERENT DIMENSIONS YFA11600.025
Nr. 1 M116_.080.0510		<b>Nr. 1</b>		
Nr. 1 M116_.110.0510		<b>Nr. 1</b>		
Nr. 2 M116_.080.0510			<b>Nr. 1</b>	<b>Nr. 1</b>
Nr. 3 M116_.080.0510			<b>Nr. 1</b>	<b>Nr. 2</b>
Nr. 2 M116_.110.0510			<b>Nr. 1</b>	<b>Nr. 1</b>
Nr. 1 M116_.110.0510 Nr. 1 M116_.080.0510			<b>Nr. 1</b>	<b>Nr. 1</b>
Nr. 1 M116_.110.0510 Nr. 2 M116_.080.0510			<b>Nr. 1</b>	<b>Nr. 2</b>

	CODICE CODE	FONTI LUMINOSE LIGHT SOURCES	kg
	<b>YFR11605.075.A02</b> <b>YFR11606.075.A02</b>	Kit di alimentazione e sospensione con rosone champagne o nero satinato, alimentatore 75W dimmerabile DALI/Push DIM, cavo di alimentazione di lunghezza 5m (196,9"), dispositivi di regolazione rapida e funi in acciaio di lunghezza 5m (196,9"). Rosone per collegamento elettrico di 1 modello M116__080.0410 o 1 modello M116__110.0410. Power supply and suspension kit with champagne or mat black canopy, 75W DALI/Push DIM dimmable driver, 5m (196,9") long power cable, griplocks and 5m (196,9") long steel cables. Canopy for power supply up to M116__080.0410 or 1 M116__110.0410 model. dimmable (DALI/Push DIM)	1,76
	<b>YFR11605.180.A02</b> <b>YFR11606.180.A02</b>	Kit di alimentazione e sospensione con rosone champagne o nero satinato, alimentatore 180W dimmerabile DALI/Push DIM, cavo di alimentazione di lunghezza 5m (196,9"), dispositivi di regolazione rapida e funi in acciaio di lunghezza 5m (196,9"). Rosone per collegamento elettrico di massimo 3 modelli M116__080.0410 o 2 modelli M116__110.0410. Power supply and suspension kit with champagne or mat black canopy, 180W DALI/Push DIM dimmable driver, 5m (196,9") long power cable, griplocks and 5m (196,9") long steel cables. Canopy for power supply up to 3 M116__080.0410 or 2 M116__110.0410 models maximum. dimmable (DALI/Push DIM)	4,74
<b>NEW</b> 	<b>YFS11601.500</b> <b>YFS11605.500</b>	Kit di sospensione con 3 funi in acciaio di lunghezza 5m (196,9"), dispositivi di regolazione rapida e cavo di alimentazione di lunghezza 5m (196,9"), per l'installazione dei modelli M106 o M116. Driver non incluso Suspension kit of 3 steel cables 5m (196.9") long, griplocks and 5m (196.9") long power cable, for installation of M106 or M116 model. Driver not included	
	<b>YFA11600.010</b>	Kit di alimentazione e sospensione per installazioni multiple con cavo di alimentazione di lunghezza 20cm (7,9") e funi in acciaio di lunghezza 8cm (3,1"). Multiple power supply and suspension kit with 20cm (7,9") long power cable and 8cm (3,1") long steel cables.	0,01
	<b>YFA11600.025</b>	Kit di alimentazione e sospensione per installazioni multiple con cavo di alimentazione di lunghezza 30cm (11,8") e funi in acciaio di lunghezza 27cm (10,6"). Multiple power supply and suspension kit with 30cm (11,8") long power cable and 27cm (10,6") long steel cables.	0,02

Fotometrie disponibili [www.panzeri.it](http://www.panzeri.it) / Photometric data available at [www.panzeri.it](http://www.panzeri.it)

#### CODICI COLORI DISPONIBILI / COLOUR CODES AVAILABLE

**05** champagne  
champagne

**06** nero satinato  
mat black

**01** bianco  
white





# OLIVIA, EMMA E CLIO

Silvia Poma 2017



Lampada a sospensione in vetro soffiato con particolare finitura a coste dal gusto retrò. Rosone in metallo rifinito con vernice poliaccrilica in color nero oppure ottone satinato. Emissione di luce diffusa con attacco E27 e lampadina LED con filamenti a vista inclusa. Vetro soffiato disponibile in 7 colorazioni: cristallo, acciaio, ambra, bronzo, tabacco, verde e bianco lucido. Cavi elettrici in tessuto nero con possibilità di personalizzarne la lunghezza. Rosone a 8 uscite (+1 centrale). Ideale per strutture hospitality o zone living residenziali.

Suspension lamp with shaded blown glass with a retro style. Ceiling metal canopy in black polyacrylic paint and in mat brass. Diffused light in LED bulb E27 distinguished by visible filaments. Seven colors glass available: crystal, steel, amber, bronze, tobacco, green and glossy white. Black fabric electrical cables and possibility to customize the length. Canopy with 8 outputs (+1 in the center). Ideal for hospitality or residential facilities.

CODICE CODE	FONTI LUMINOSE LIGHT SOURCES	kg
-------------	------------------------------	----

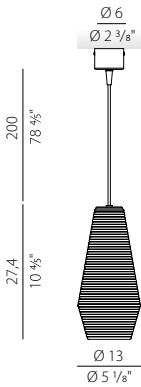

- L09751.000.0200**
- L09752.000.0200**
- L09753.000.0200**
- L09754.000.0200**
- L09755.000.0200**
- L09756.000.0200**
- L09757.000.0200**
- L09771.000.0200**
- L09772.000.0200**
- L09773.000.0200**
- L09774.000.0200**
- L09775.000.0200**
- L09776.000.0200**
- L09777.000.0200**

LED retrofit bulb 8W E27 2700K Ra80 1050lm (no dimming) \* max 57W E27 0,95

**IP20**  
Sorgente luminosa LED inclusa  
LED bulb included

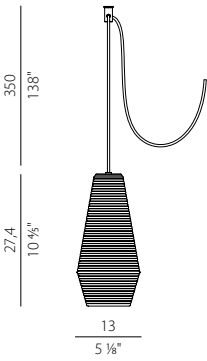

- M09751.000.0200**
- M09752.000.0200**
- M09753.000.0200**
- M09754.000.0200**
- M09755.000.0200**
- M09756.000.0200**
- M09757.000.0200**
- M09771.000.0200**
- M09772.000.0200**
- M09773.000.0200**
- M09774.000.0200**
- M09775.000.0200**
- M09776.000.0200**
- M09777.000.0200**

LED retrofit bulb 8W E27 2700K Ra80 1050lm (no dimming) \* max 57W E27 0,92

**IP20**  
Fornito senza rosone, con cavo di collegamento 3,5m e appendimento M800, per composizioni multiple. Sorgente luminosa LED inclusa  
Supplied without canopy, with 3,5m cable and M800 polycarbonate hook for multiple configurations. LED bulb included

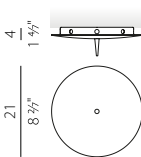

- M91/94/9702**
- M91/94/9719**

Rosone per collegamento elettrico di massimo 9 modelli M091\_\_000.0200/ M094\_\_000.0200/M097\_\_000.0200. 0,50  
Canopy for power supply up to 9 M091\_\_000.0200/M094\_\_000.0200/ M097\_\_000.0200 models maximum.

Fotometrie disponibili [www.panzeri.it](http://www.panzeri.it) / Photometric data available at [www.panzeri.it](http://www.panzeri.it)

## CODICI COLORI DISPONIBILI / COLOUR CODES AVAILABLE

<b>51</b> nero diffusore bianco black/white diffuser	<b>52</b> nero diffusore cristallo black/crystal diffuser	<b>53</b> nero diffusore acciaio black/steel diffuser	<b>54</b> nero diffusore ambra black/amber diffuser	<b>55</b> nero diffusore bronzo black/bronze diffuser	<b>56</b> nero diffusore tabacco black/tobacco diffuser	<b>57</b> nero diffusore verde black/green diffuser
<b>71</b> ottone satinato diffusore bianco mat brass white diffuser	<b>72</b> ottone satinato diffusore cristallo mat brass crystal diffuser	<b>73</b> ottone satinato diffusore acciaio mat brass steel diffuser	<b>74</b> ottone satinato diffusore ambra mat brass amber diffuser	<b>75</b> ottone satinato diffusore bronzo mat brass bronze diffuser	<b>76</b> ottone satinato diffusore tabacco mat brass tobacco diffuser	<b>77</b> ottone satinato diffusore verde mat brass green diffuser



**ROSONI E DECENTRAMENTI A PAGINA 96 / OFFSET AND CANOPIES PAGE 96**





# OLIVIA, EMMA E CLIO

Silvia Poma 2015

Registered Design



Lampada a sospensione in vetro soffiato con particolare finitura a coste dal gusto retrò. Rosone in metallo rifinito con vernice poliaccrilica in color nero oppure ottone satinato. Emissione di luce diffusa con attacco E27 e lampadina LED con filamenti a vista inclusa. Vetro soffiato disponibile in 7 colorazioni: cristallo, acciaio, ambra, bronzo, tabacco, verde e bianco lucido. Cavi elettrici in tessuto nero con possibilità di personalizzarne la lunghezza. Rosone a 8 uscite (+1 centrale). Ideale per strutture hospitality o zone living residenziali.

Suspension lamp with shaded blown glass with a retro style. Ceiling metal canopy in black polyacrylic paint and in mat brass. Diffused light in LED bulb E27 distinguished by visible filaments. Seven colors glass available: crystal, steel, amber, bronze, tobacco, green and glossy white. Black fabric electrical cables and possibility to customize the lenght. Canopy with 8 outputs (+1 in the center). Ideal for hospitality or residential facilities.

	CODICE CODE	FONTI LUMINOSE LIGHT SOURCES	kg
	<b>L09151.000.0200</b>	LED retrofit bulb 8W E27 2700K Ra80 1050lm (no dimming) *	1,50
	<b>L09152.000.0200</b>	max 57W E27	
	<b>L09153.000.0200</b>	<b>IP20</b>	
	<b>L09154.000.0200</b>	Sorgente luminosa LED inclusa	
	<b>L09155.000.0200</b>	LED bulb included	
	<b>L09156.000.0200</b>		
	<b>L09157.000.0200</b>		
	<b>L09171.000.0200</b>		
	<b>L09172.000.0200</b>		
	<b>L09173.000.0200</b>		
	<b>L09174.000.0200</b>		
	<b>L09175.000.0200</b>		
	<b>L09176.000.0200</b>		
	<b>L09177.000.0200</b>		

	<b>M09151.000.0200</b>	LED retrofit bulb 8W E27 2700K Ra80 1050lm (no dimming) *	1,47
	<b>M09152.000.0200</b>	max 57W E27	
	<b>M09153.000.0200</b>	<b>IP20</b>	
	<b>M09154.000.0200</b>	Fornito senza rosone, con cavo di collegamento 3,5m e appendimento M800,	
	<b>M09155.000.0200</b>	per composizioni multiple. Sorgente luminosa LED inclusa	
	<b>M09156.000.0200</b>	Supplied without canopy, with 3,5m cable and M800 polycarbonate hook for	
	<b>M09157.000.0200</b>	multiple configurations. LED bulb included	
	<b>M09171.000.0200</b>		
	<b>M09172.000.0200</b>		
	<b>M09173.000.0200</b>		
	<b>M09174.000.0200</b>		
	<b>M09175.000.0200</b>		
	<b>M09176.000.0200</b>		
	<b>M09177.000.0200</b>		

	<b>M91/94/9702</b>	Rosone per collegamento elettrico di massimo 9 modelli M091__000.0200/	0,50
	<b>M91/94/9719</b>	M094__000.0200/M097__000.0200. Canopy for power supply up to 9 M091__000.0200/M094__000.0200/ M097__000.0200 models maximum.	

Fotometrie disponibili [www.panzeri.it](http://www.panzeri.it) / Photometric data available at [www.panzeri.it](http://www.panzeri.it)

## CODICI COLORI DISPONIBILI / COLOUR CODES AVAILABLE

<b>51</b> nero diffusore bianco black/white diffuser	<b>52</b> nero diffusore cristallo black/crystal diffuser	<b>53</b> nero diffusore acciaio black/steel diffuser	<b>54</b> nero diffusore ambra black/amber diffuser	<b>55</b> nero diffusore bronzo black/bronze diffuser	<b>56</b> nero diffusore tabacco black/tobacco diffuser	<b>57</b> nero diffusore verde black/green diffuser
<b>71</b> ottone satinato diffusore bianco mat brass white diffuser	<b>72</b> ottone satinato diffusore cristallo mat brass crystal diffuser	<b>73</b> ottone satinato diffusore acciaio mat brass steel diffuser	<b>74</b> ottone satinato diffusore ambra mat brass amber diffuser	<b>75</b> ottone satinato diffusore bronzo mat brass bronze diffuser	<b>76</b> ottone satinato diffusore tabacco mat brass tobacco diffuser	<b>77</b> ottone satinato diffusore verde mat brass green diffuser



ROSONI E DECENTRAMENTI A PAGINA 96 / OFFSET AND CANOPIES PAGE 96



# OLIVIA, EMMA E CLIO

Silvia Poma 2015

Registered Design



Lampada a sospensione in vetro soffiato con particolare finitura a coste dal gusto retrò. Rosone in metallo rifinito con vernice poliaccrilica in color nero oppure ottone satinato. Emissione di luce diffusa con attacco E27 e lampadina LED con filamenti a vista inclusa. Vetro soffiato disponibile in 7 colorazioni: cristallo, acciaio, ambra, bronzo, tabacco, verde e bianco lucido. Cavi elettrici in tessuto nero con possibilità di personalizzarne la lunghezza. Rosone a 8 uscite (+1 centrale). Ideale per strutture hospitality o zone living residenziali.

Suspension lamp with shaded blown glass with a retro style. Ceiling metal canopy in black polyacrylic paint and in mat brass. Diffused light in LED bulb E27 distinguished by visible filaments. Seven colors glass available: crystal, steel, amber, bronze, tobacco, green and glossy white. Black fabric electrical cables and possibility to customize the length. Canopy with 8 outputs (+1 in the center). Ideal for hospitality or residential facilities.

CODICE CODE	FONTI LUMINOSE LIGHT SOURCES	kg
-------------	------------------------------	----

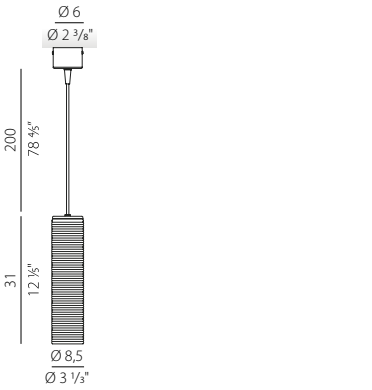

	<b>L09451.000.0200</b> <b>L09452.000.0200</b> <b>L09453.000.0200</b> <b>L09454.000.0200</b> <b>L09455.000.0200</b> <b>L09456.000.0200</b> <b>L09457.000.0200</b> <b>L09471.000.0200</b> <b>L09472.000.0200</b> <b>L09473.000.0200</b> <b>L09474.000.0200</b> <b>L09475.000.0200</b> <b>L09476.000.0200</b> <b>L09477.000.0200</b>	LED retrofit bulb 8W E27 2700K Ra80 1050lm (no dimming) * max 57W E27  <b>IP20</b> Sorgente luminosa LED inclusa LED bulb included	1,32
--	--	--	------

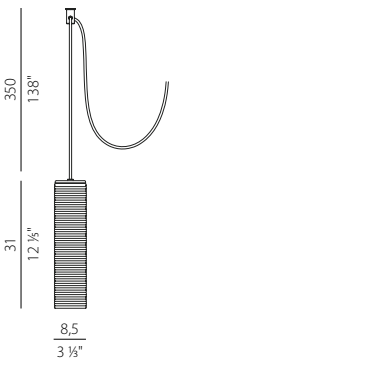

	<b>M09451.000.0200</b> <b>M09452.000.0200</b> <b>M09453.000.0200</b> <b>M09454.000.0200</b> <b>M09455.000.0200</b> <b>M09456.000.0200</b> <b>M09457.000.0200</b> <b>M09471.000.0200</b> <b>M09472.000.0200</b> <b>M09473.000.0200</b> <b>M09474.000.0200</b> <b>M09475.000.0200</b> <b>M09476.000.0200</b> <b>M09477.000.0200</b>	LED retrofit bulb 8W E27 2700K Ra80 1050lm (no dimming) * max 57W E27  <b>IP20</b> Fornito senza rosone, con cavo di collegamento 3,5m e appendimento M800, per composizioni multiple. Sorgente luminosa LED inclusa Supplied without canopy, with 3,5m cable and M800 polycarbonate hook for multiple configurations. LED bulb included	1,29
--	--	--	------

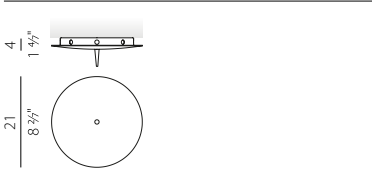

<b>M91/94/9702</b> <b>M91/94/9719</b>	Rosone per collegamento elettrico di massimo 9 modelli M091__000.0200/ M094__000.0200/M097__000.0200. Canopy for power supply up to 9 M091__000.0200/M094__000.0200/ M097__000.0200 models maximum.	0,50
--	--	------

Fotometrie disponibili [www.panzeri.it](http://www.panzeri.it) / Photometric data available at [www.panzeri.it](http://www.panzeri.it)

## CODICI COLORI DISPONIBILI / COLOUR CODES AVAILABLE

<b>51</b> nero diffusore bianco black/white diffuser	<b>52</b> nero diffusore cristallo black/crystal diffuser	<b>53</b> nero diffusore acciaio black/steel diffuser	<b>54</b> nero diffusore ambra black/amber diffuser	<b>55</b> nero diffusore bronzo black/bronze diffuser	<b>56</b> nero diffusore tabacco black/tobacco diffuser	<b>57</b> nero diffusore verde black/green diffuser
<b>71</b> ottone satinato diffusore bianco mat brass white diffuser	<b>72</b> ottone satinato diffusore cristallo mat brass crystal diffuser	<b>73</b> ottone satinato diffusore acciaio mat brass steel diffuser	<b>74</b> ottone satinato diffusore ambra mat brass amber diffuser	<b>75</b> ottone satinato diffusore bronzo mat brass bronze diffuser	<b>76</b> ottone satinato diffusore tabacco mat brass tobacco diffuser	<b>77</b> ottone satinato diffusore verde mat brass green diffuser



ROSONI E DECENTRAMENTI A PAGINA 96 / OFFSET AND CANOPIES PAGE 96



Famiglia di prodotti da tavolo e parete con struttura snodata per il posizionamento ottimale della fonte luminosa rispetto alla superficie di lavoro, ideale in ambienti lavorativi o per l'illuminazione di tavoli e scrivanie in ambito domestico e hospitality. Il telaio è realizzato in alluminio tubolare con elementi snodati in alluminio pressofuso e tiranti in fune di acciaio; la testa orientabile in pressofusione di alluminio e equipaggiata di sorgente LED con intensità e tonalità di luce regolabili secondo la tecnologia DIM-to-warm; l'elettronica di bordo inoltre è configurabile in modalità bianco dinamico, con luce di colorazione variabile da bianco caldo a bianco naturale. Disponibile versione da tavolo con sensore di presenza. Tutti i modelli sono disponibili con verniciatura poliaccrilica in colore bianco, nero satinato, bronzo, ottone satinato o titanio. Per la versione da tavolo disponibili le nuove finiture verde oliva materico e terracotta naturale materico.

Opuntia is a series of table and wall lamps with jointed structure for optimal positioning of the light source with respect to the working plan, ideal for workstations or for the illumination of tables and desks in home or hospitality settings. The structure is built in tube-shaped aluminum with jointed elements in aluminum die-cast and tie-rods in steel; the adjustable head in aluminum die-cast is equipped with a LED board with technology DIM-to-warm to regulate light intensity and color temperature accordingly; the electronics onboard allow to set also on tunable white, with fixed light intensity and color temperature ranging from warm white to cold white. Presence detector version available. All models are available in polyacrylic paint in finish white, satin black, bronze, mat brass and titanium. For table version, new finishes textured olive green and textured natural terracotta are available.

CODICE CODE	FONTI LUMINOSE LIGHT SOURCES	kg
<b>C06801.000.9121</b>	Potenza assorbita apparecchio / Luminaire power consumption 8,5W	3,45
<b>C06806.000.9121</b>	Flusso luminoso apparecchio / Luminaire luminous flux 700lm	
<b>C06817.000.9121</b>	2200-4000K Ra>90 220-240V AC DIM-to-warm + tunable white	
<b>C06819.000.9121</b>	IP40	
<b>C06827.000.9121</b>		
<b>C06829.000.9121</b>		
<b>C06830.000.9121</b>		
<b>C06801.000.9121P</b>	Potenza assorbita apparecchio / Luminaire power consumption 8,5W	1,20
<b>C06806.000.9121P</b>	Flusso luminoso apparecchio / Luminaire luminous flux 700lm	
<b>C06817.000.9121P</b>	2200-4000K Ra>90 220-240V AC DIM-to-warm + tunable white	
<b>C06819.000.9121P</b>	IP40	
<b>C06827.000.9121P</b>		
<b>C06829.000.9121P</b>	Versione con sensore di presenza	
<b>C06830.000.9121P</b>	Presence detector version	

NEW

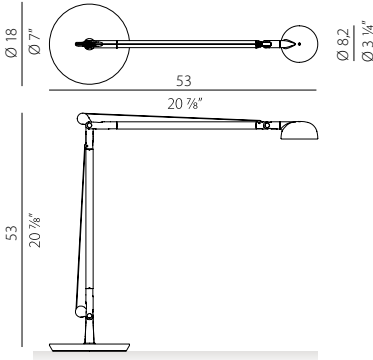

- C06801.000.9121**
- C06806.000.9121**
- C06817.000.9121**
- C06819.000.9121**
- C06827.000.9121**
- C06829.000.9121**
- C06830.000.9121**

Potenza assorbita apparecchio / Luminaire power consumption 8,5W  
 Flusso luminoso apparecchio / Luminaire luminous flux 700lm  
 2200-4000K Ra>90 220-240V AC DIM-to-warm + tunable white

IP40

Potenza assorbita apparecchio / Luminaire power consumption 8,5W  
 Flusso luminoso apparecchio / Luminaire luminous flux 700lm  
 2200-4000K Ra>90 220-240V AC DIM-to-warm + tunable white

IP40

Versione con sensore di presenza  
Presence detector version



- A06801.130.9121**
- A06806.130.9121**
- A06817.130.9121**
- A06819.130.9121**
- A06830.130.9121**

Potenza assorbita apparecchio / Luminaire power consumption 8,5W  
 Flusso luminoso apparecchio / Luminaire luminous flux 700lm  
 2200-4000K Ra>90 220-240V AC DIM-to-warm + tunable white

IP40

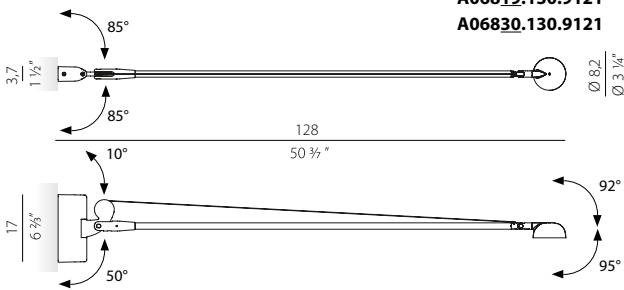

- A06801.180.9121**
- A06806.180.9121**
- A06817.180.9121**
- A06819.180.9121**
- A06830.180.9121**

Potenza assorbita apparecchio / Luminaire power consumption 8,5W  
 Flusso luminoso apparecchio / Luminaire luminous flux 700lm  
 2200-4000K Ra>90 220-240V AC DIM-to-warm + tunable white

IP40

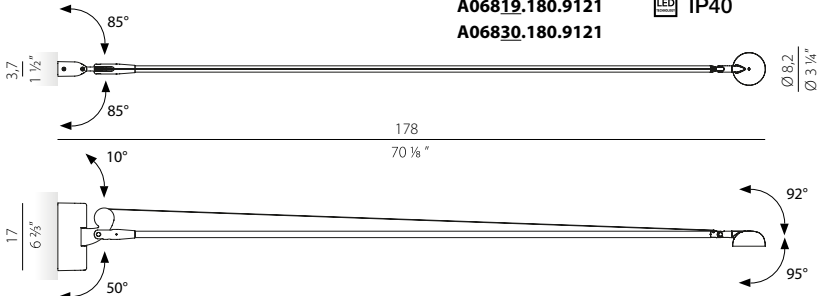

Fotometrie disponibili [www.panzeri.it](http://www.panzeri.it) / Photometric data available at [www.panzeri.it](http://www.panzeri.it)

CODICI COLORI DISPONIBILI / COLOUR CODES AVAILABLE

<b>01</b> bianco white	<b>06</b> nero satinato mat black	<b>17</b> bronzo bronze	<b>19</b> ottone satinato mat brass	<b>27</b> verde oliva materico textured olive green	<b>29</b> terracotta naturale materico textured natural terracotta	<b>30</b> titanio titanium
---------------------------	--------------------------------------	----------------------------	--	--	---	-------------------------------



Una famiglia di prodotti che rappresenta un prestigioso connubio tra classicità e modernità. La sapiente unione di forme che evocano il passato, materiali raffinati e tecnologie contemporanee crea un prodotto senza tempo, in grado di esaltare la texture del vetro cattedrale attraverso una luce morbida e diffusa. Roma diventa assoluta protagonista dello spazio che occupa grazie al suo carattere forte e distintivo. Disponibile in versione sospensione, parete e terra, con basamento in metallo oppure in travertino, sia per ambienti interni che esterni.

A family of products that represents a prestigious blend of classicism and modernity. The clever combination of shapes that evoke the past, refined materials and contemporary technology creates a timeless product that enhances the texture of cathedral glass through soft, diffused light. Roma becomes the absolute protagonist of the room thanks to its strong and distinctive character. Available in suspension, wall and floor version, for both indoor and outdoor use, with a metal or travertine base.

**NEW**

**CODICE CODE**

**FONTI LUMINOSE LIGHT SOURCES**

**kg**



**T14817.185.0527**

Potenza assorbita apparecchio / Luminaire power consumption 70W  
 Flusso luminoso apparecchio / Luminaire luminous flux 5400lm  
 2700K Ra>90 220-240V AC dimmable (Push DIM)

56,00

**IP20**

Fornito completo di dimmer a sfioramento, cavo 2,5m e spina  
 Supplied with dimmer touch, 2,5m cable and plug

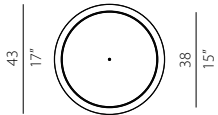
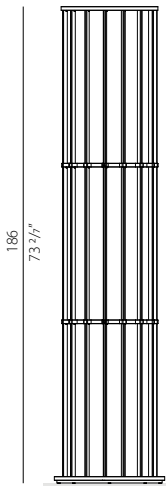

**T14817.200.0527**

Potenza assorbita apparecchio / Luminaire power consumption 70W  
 Flusso luminoso apparecchio / Luminaire luminous flux 5400lm  
 2700K Ra>90 220-240V AC dimmable (Push DIM)

72,00

**IP20**

Base di appoggio in travertino.  
 Fornito completo di dimmer a sfioramento, cavo 2,5m e spina  
 Base travertine.  
 Supplied with dimmer touch, 2,5m cable and plug

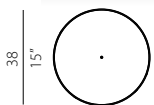
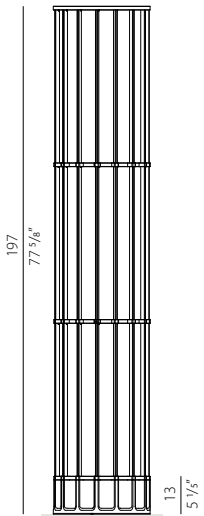

# ROMA

Scandurra 2024

Registered Design

	CODICE CODE	FONTI LUMINOSE LIGHT SOURCES	kg
	<b>L14817.030.0502</b>	Potenza assorbita apparecchio / Luminaire power consumption 36W Flusso luminoso apparecchio / Luminaire luminous flux 2800lm 2700K Ra>90 220-240V AC dimmable (DALI/Push DIM) <b>LED IP20</b>	13,50

	<b>A14817.036.0502</b>	Potenza assorbita apparecchio / Luminaire power consumption 18W Flusso luminoso apparecchio / Luminaire luminous flux 1370lm 2700K Ra>90 220-240V AC dimmable (DALI/Push DIM) <b>LED IP20</b>	7,50
--	------------------------	--	------

Fotometrie disponibili [www.panzeri.it](http://www.panzeri.it) / Photometric data available at [www.panzeri.it](http://www.panzeri.it)

CODICI COLORI DISPONIBILI / COLOUR CODES AVAILABLE

**17** bronzo  
bronze

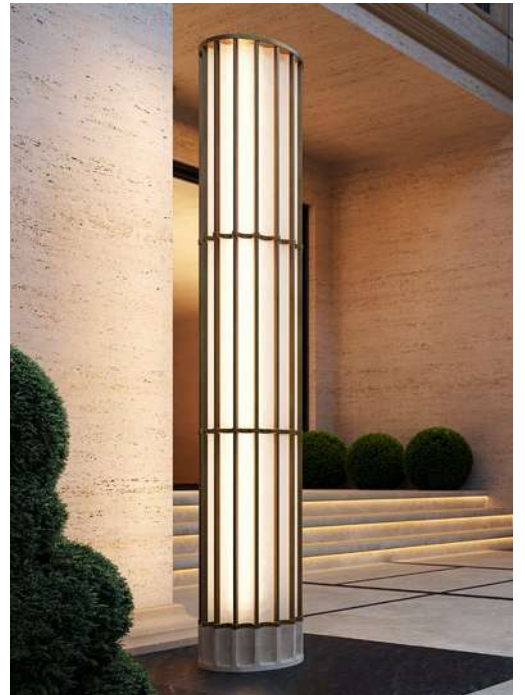





Roris è una famiglia di apparecchi di illuminazione con un forte carattere decorativo ispirato alla natura, capace di adattarsi ed integrarsi, con le diverse versioni, ad ambienti interni eleganti, minimali e moderni, sia residenziali che commerciali. La famiglia Roris prende spunto dalle forme sottili e flessibili della flora, in un gioco di segni e traiettorie che, con semplicità, arreda e illumina l'ambiente. I 6 bracci curvi delle versioni a plafone e a incasso parziale, distribuiti ritmicamente su un corpo centrale affusolato, portano 8 corpi illuminanti di vetro dalla forma tondeggiante simile gocce di rugiada. Sono disponibili anche le versioni da parete e da tavolo, che illuminano lo spazio in maniera diffusa. Tutte le versioni disponibili in finitura nero satinato e ottone satinato.

Roris is a family of lighting fixtures with a strong decorative character inspired by nature, capable of adapting and integrating, with its different versions, into elegant, minimalist and modern interiors, both residential and commercial. The Roris family comes from the thin and flexible forms of flora, in a play of signs and trajectories that simply furnish and illuminate the environment. The 6 curved arms of the surface-mounted and partially recessed versions, rhythmically distributed over a tapered central body, carry 8 glass light fittings with a rounded dewdrop-like shape. Wall and table versions are also available, illuminating the space in a diffuse manner. All versions are available in mat black and mat brass finishes.

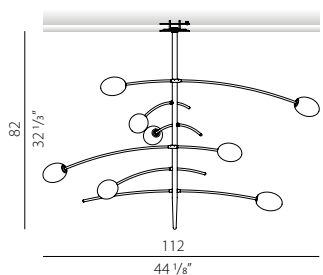
CODICE CODE	FONTI LUMINOSE LIGHT SOURCES	kg
-------------	------------------------------	----





 **X11206.008.0500**  
**X11219.008.0500**

8x LED retrofit bulb 3W G9 2700K Ra80 250lm dimmable max 4W G9  
Potenza assorbita apparecchio / Luminaire power consumption 24W  
Flusso luminoso apparecchio / Luminaire luminous flux 1272lm  
220-240V AC

2,82

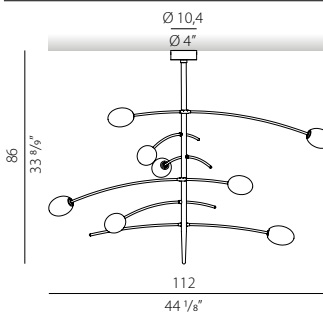
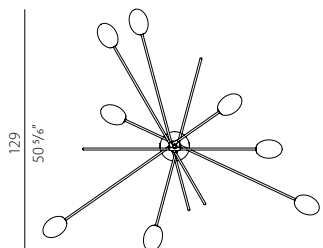
**IP20**  
Sorgente luminosa LED inclusa  
LED bulb included



 **P11206.008.0500**  
**P11219.008.0500**

8x LED retrofit bulb 3W G9 2700K Ra80 250lm dimmable max 4W G9  
Potenza assorbita apparecchio / Luminaire power consumption 24W  
Flusso luminoso apparecchio / Luminaire luminous flux 1272lm  
220-240V AC

2,71

**IP20**  
Sorgente luminosa LED inclusa  
LED bulb included

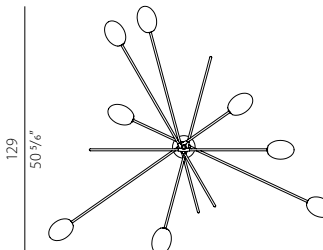

	CODICE CODE	FONTI LUMINOSE LIGHT SOURCES	kg
	<b>A11206.003.0500</b>	3x LED retrofit bulb 3W G9 2700K Ra80 250lm dimmable	1,14
	<b>A11219.003.0500</b>	max 4W G9 Potenza assorbita apparecchio / Luminaire power consumption 9W Flusso luminoso apparecchio / Luminaire luminous flux 545lm 220-240V AC	
		<b>IP20</b> Sorgente luminosa LED inclusa LED bulb included	

	<b>C11206.001.0500</b>	1x LED retrofit bulb 3W G9 2700K Ra80 250lm	0,48
	<b>C11219.001.0500</b>	max 4W G9 Potenza assorbita apparecchio / Luminaire power consumption 3W Flusso luminoso apparecchio / Luminaire luminous flux 182lm 220-240V AC	
		<b>IP20</b> Sorgente luminosa LED inclusa LED bulb included	

Fotometrie disponibili [www.panzeri.it](http://www.panzeri.it) / Photometric data available at [www.panzeri.it](http://www.panzeri.it)

#### CODICI COLORI DISPONIBILI / COLOUR CODES AVAILABLE

**06** nero satinato  
mat black

**19** ottone satinato  
mat brass





# SMOKE

Silvia Poma 2018



Lampada a sospensione in vetro soffiato lavorato a mano con effetto sfumato. Rosone in metallo spazzolato e verniciato colore titanio. Emissione di luce diffusa con attacco E27, lampadina LED dimmerabile inclusa. Vetro soffiato disponibile in tre misure, in colore bianco sfumato, fumè sfumato e verde foresta sfumato. Cavo elettrico trasparente.

Suspension lamp in handmade blown glass in shaded effect. Metal part brushed and painted in titanium finish. Diffused light emission with E27 socket, LED bulb dimmable included. Blown glass available in three sizes, in shaded white, shaded smoky grey and shaded green forest. Transparent electric cable.

**NEW**

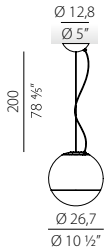

**L01540.027.0200**

**L01541.027.0200**

**L01543.027.0200**

LED retrofit bulb 21W E27 2700K Ra80 2500lm (dimnable)  
max 116W E27

**IP20**

Sorgente luminosa LED inclusa  
LED bulb included

kg

2,46

**NEW**

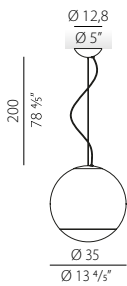

**L01540.035.0200**

**L01541.035.0200**

**L01543.035.0200**

LED retrofit bulb 21W E27 2700K Ra80 2500lm (dimnable)  
max 116W E27

**IP20**

Sorgente luminosa LED inclusa  
LED bulb included

2,90

**NEW**

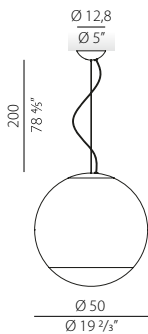

**L01540.050.0200**

**L01541.050.0200**

**L01543.050.0200**

LED retrofit bulb 21W E27 2700K Ra80 2500lm (dimnable)  
max 116W E27

**IP20**

Sorgente luminosa LED inclusa  
LED bulb included

7,02

Fotometrie disponibili [www.panzeri.it](http://www.panzeri.it) / Photometric data available at [www.panzeri.it](http://www.panzeri.it)

## CODICI COLORI DISPONIBILI / COLOUR CODES AVAILABLE

**40** titanio/diffusore fumé  
titanium/smoky grey diffuser

**41** titanio/diffusore bianco  
titanium/white diffuser

**43** titanio/diffusore verde foresta  
titanium/forest green diffuser







Lampada LED da parete/soffitto in alluminio verniciato poliaccrilico bianco, bronzo, ottone satinato, nero e vetro satinato.

LED wall/ceiling lamp in aluminium colored in white, bronze, mat brass, black polyacrylic paint and mat glass.

	CODICE CODE	FONTI LUMINOSE LIGHT SOURCES	kg
	<b>P03901.011.0406</b>	Potenza assorbita apparecchio / Luminaire power consumption 10W	0,51
	<b>P03902.011.0406</b>	Flusso luminoso apparecchio / Luminaire luminous flux 595lm	
	<b>P03917.011.0406</b>	3000K Ra>90 220-240V AC ON-OFF	
	<b>P03919.011.0406</b>	IP40	
	<b>P03901.015.0406</b>	Potenza assorbita apparecchio / Luminaire power consumption 15W	1,32
	<b>P03902.015.0406</b>	Flusso luminoso apparecchio / Luminaire luminous flux 956lm	
	<b>P03917.015.0406</b>	3000K Ra>90 220-240V AC ON-OFF	
	<b>P03919.015.0406</b>	IP40	
	<b>XM14/230</b>	Dispositivo dimmerabile per moduli LED a 230V, 5÷100W. Dimmable device for 230V LED modules, 5÷100W.	

Fotometrie disponibili [www.panzeri.it](http://www.panzeri.it) / Photometric data available at [www.panzeri.it](http://www.panzeri.it)

### CODICI COLORI DISPONIBILI / COLOUR CODES AVAILABLE

- |                           |                         |                            |  |
|---------------------------|-------------------------|----------------------------|--|
| <b>01</b> bianco<br>white | <b>02</b> nero<br>black | <b>17</b> bronzo<br>bronze | <b>19</b> ottone satinato<br>mat brass |
|---------------------------|-------------------------|----------------------------|--|

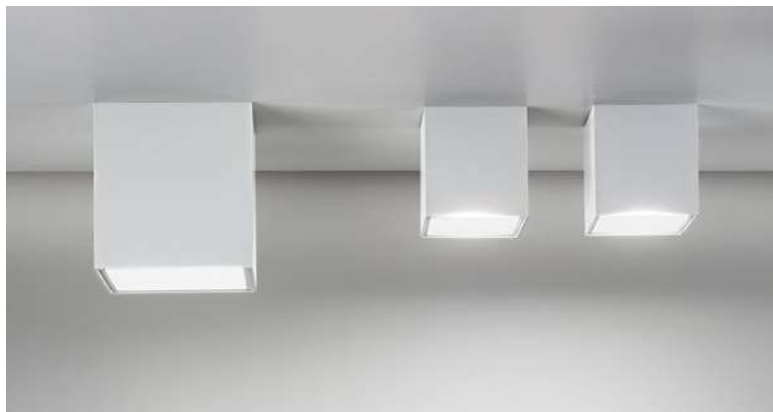



Lampada a sospensione in alluminio estruso disponibile in  $\varnothing$  22mm o  $\varnothing$  32 mm e rispettive lunghezze 850mm/650mm. Lampada a sospensione e plafone in alluminio estruso con  $\varnothing$  55 mm e lunghezza 450mm. La versione con  $\varnothing$  55mm prevede la possibilità di installare tre ottiche con fascio 20°, 35°, 55°. Sorgente luminosa composta da modulo LED ad elevate prestazioni CRI>90 2700K. Rosone con driver ON-OFF integrato nella versione  $\varnothing$  22mm. Driver ON-OFF integrato nel cilindro nella versione  $\varnothing$  32mm e 55mm. Finitura con vernice poliaccrilica in bianco, nero satinato, bronzo, ottone satinato o finitura in foglia oro decorata a mano. Cavo elettrico trasparente ultrasottile. Ideale per ristoranti, zone living, camere da letto o per creare grandi composizioni a cascata.

Aluminum extruded suspension lamp in  $\varnothing$  22mm or  $\varnothing$  32mm diameter and respectively 850mm/650mm length. Aluminum extruded suspension and ceiling lamp in  $\varnothing$  55mm and length 450mm. The version in  $\varnothing$  55mm is available with three different beam angles 20°, 35°, 55°. Light sources made of highly performing LED module with CRI>90 2700K. Canopy with ON-OFF driver integrated in the  $\varnothing$  22mm version. Integrated ON-OFF driver inside the cylinder for the versions  $\varnothing$  32mm and 55mm. Finish in white, mat black, bronze, mat brass polyacrylic paint or hand-made decorated in golden leaf. Ultra-thin transparent electrical cable. Ideal for restaurants, living areas, bedrooms, and to create big cascading compositions.

	CODICE CODE	FONTI LUMINOSE LIGHT SOURCES	kg
	<b>L02501.085.0501</b>	Potenza assorbita apparecchio / Luminaire power consumption 4W	0,75
	<b>L02506.085.0501</b>	Flusso luminoso apparecchio / Luminaire luminous flux 181lm	
	<b>L02517.085.0501</b>	2700K Ra>90 220-240V AC ON-OFF	
	<b>IP40</b>		
	<b>L02521.085.0501</b>	Fornito con cavo di collegamento 5m, senza rosone e driver, per composizioni multiple o <b>in combinazione con Hilow</b> Supplied with 5m cable, without canopy and driver, for multiple configurations or configurations with Hilow	
	<b>L02601.065.0501</b>	Potenza assorbita apparecchio / Luminaire power consumption 7W	0,74
	<b>L02606.065.0501</b>	Flusso luminoso apparecchio / Luminaire luminous flux 363lm	
	<b>L02617.065.0501</b>	2700K Ra>90 220-240V AC ON-OFF	
	<b>IP40</b>		
	<b>L02621.065.0501</b>		
	<b>L02701.045.1701</b>	Potenza assorbita apparecchio / Luminaire power consumption 10W	1,13
	<b>L02706.045.1701</b>	Flusso luminoso apparecchio / Luminaire luminous flux 806lm	
	<b>L02717.045.1701</b>	2700K Ra>90 35° 220-240V AC ON-OFF	
	<b>IP20</b>		
	<b>L02721.045.1701</b>	Per progetti a richiesta ottiche 20° e 55° Beam angles 20°, 55° on request for projects	

	CODICE CODE	FONTI LUMINOSE LIGHT SOURCES	kg	
	<b>M02501.085.0510</b> <b>M02506.085.0510</b> <b>M02517.085.0510</b> <b>M02519.085.0510</b> <b>M02521.085.0510</b>	Potenza assorbita apparecchio / Luminaire power consumption 2,8W Flusso luminoso apparecchio / Luminaire luminous flux 181lm 2700K Ra>90 24V DC LED IP40 Fornito con cavo di collegamento 5m, senza rosone e driver, per composizioni multiple o <b>in combinazione con Hilow</b> Supplied with 5m cable, without canopy and driver, for multiple configurations or <b>configurations with Hilow</b>	0,64	
	<b>M02601.065.0510</b> <b>M02606.065.0510</b> <b>M02617.065.0510</b> <b>M02619.065.0510</b> <b>M02621.065.0510</b>	Potenza assorbita apparecchio / Luminaire power consumption 5,3W Flusso luminoso apparecchio / Luminaire luminous flux 363lm 2700K Ra>90 24V DC LED IP40 Fornito senza rosone e driver, per composizioni multiple Supplied without canopy and driver, for multiple configurations	0,76	
	<b>M800</b>	Appendimento in policarbonato per sospensione. Polycarbonate hook for suspension.	0,01	
		<b>P02701.045.1701</b> <b>P02706.045.1701</b> <b>P02717.045.1701</b> <b>P02719.045.1701</b> <b>P02721.045.1701</b>	Potenza assorbita apparecchio / Luminaire power consumption 10W Flusso luminoso apparecchio / Luminaire luminous flux 806lm 2700K Ra>90 35° 220-240V AC ON-OFF LED IP20 Per progetti a richiesta ottiche 20° e 55° Beam angles 20°, 55° on request for projects	0,85
		Fotometrie disponibili <a href="http://www.panzeri.it">www.panzeri.it</a> / Photometric data available at <a href="http://www.panzeri.it">www.panzeri.it</a>		
<b>CODICI COLORI DISPONIBILI / COLOUR CODES AVAILABLE</b>				
<b>01</b> bianco white		<b>06</b> nero satinato mat black	<b>17</b> bronzo bronze	<b>19</b> ottone satinato mat brass

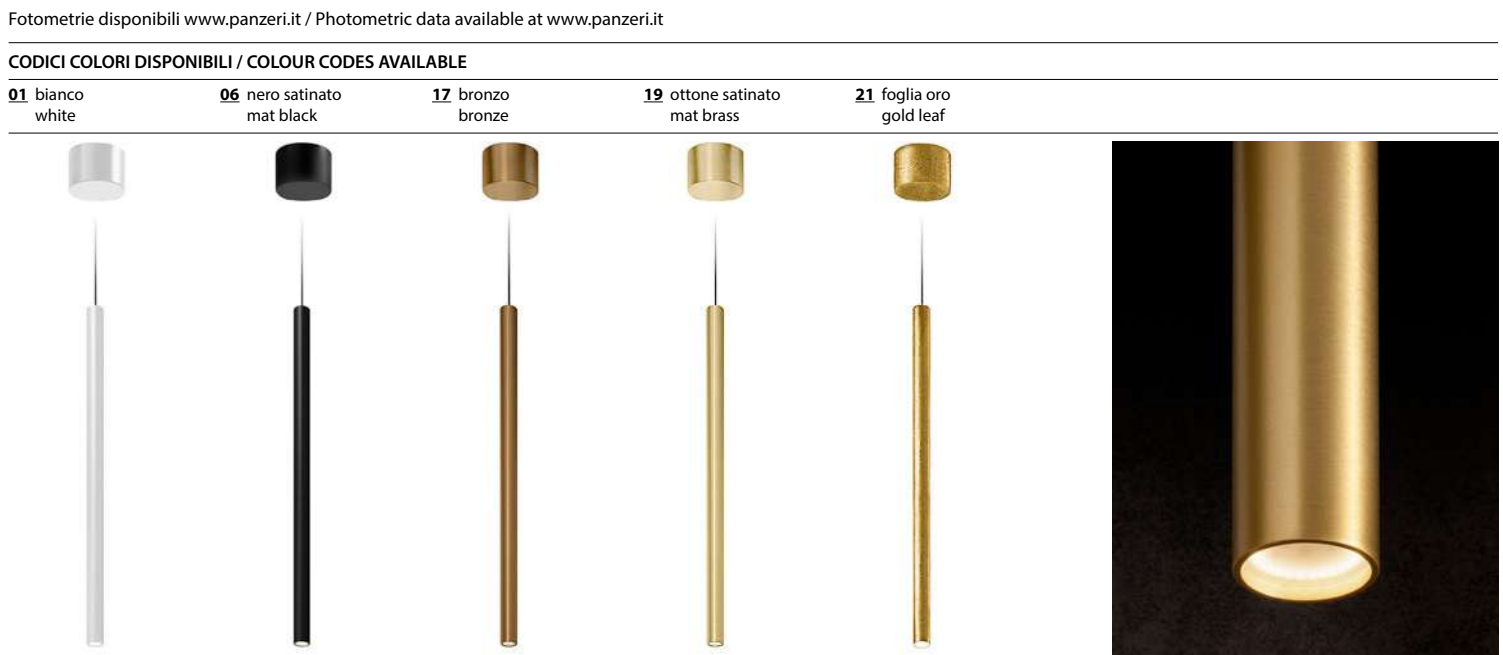









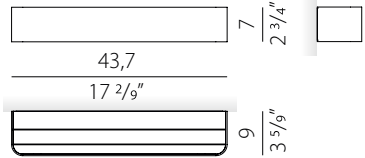

Lampada da parete biemissione che unisce minimalismo, geometria e alte prestazioni. La geometria del corpo in alluminio estruso indirizza il flusso luminoso verso il centro della stanza. La forma semplice, scandita dalle linee curve e dalle raggiate morbide della cover esterna con accoppiamento magnetico, si adatta a varie tipologie di ambiente. Le diverse lunghezze disponibili rendono l'apparecchio adatto per installazioni singole e composizioni di più elementi, in corridoi, aree di passaggio e locali ampi. Disponibile in finitura bianca, nera, bronzo, ottone satinato e titanio. Disponibili a richiesta le finiture verde oliva materico e terracotta naturale materico.

Double-emission wall lamp that combines minimalism, geometry and high performance. The geometry of the extruded body directs the luminous flux towards the centre of the room. The simple shape, defined by the curved lines and edges of the external cover with magnetic coupling, adapts to various types of environment. The different available lengths make the fixture suitable for single installations and multi-element compositions, in corridors, transit areas and large ambiances. Available in white, black, bronze, mat brass and titanium finishes. Textured olive green and textured natural terracotta finishes available on request.

NEW	CODICE CODE	FONTI LUMINOSE LIGHT SOURCES	kg
	<b>A14201.015.0504</b>	Potenza assorbita apparecchio / Luminaire power consumption 10W	0,82
	<b>A14202.015.0504</b>	Flusso luminoso apparecchio / Luminaire luminous flux 657lm	
	<b>A14217.015.0504</b>	2700K Ra>90 220-240V AC dimmable (phase cut)	
	<b>A14219.015.0504</b>	IP20	
	<b>A14201.015.0404</b>	Potenza assorbita apparecchio / Luminaire power consumption 10W	0,82
	<b>A14202.015.0404</b>	Flusso luminoso apparecchio / Luminaire luminous flux 657lm	
	<b>A14217.015.0404</b>	3000K Ra>90 220-240V AC dimmable (phase cut)	
	<b>A14219.015.0404</b>	IP20	
	<b>A14201.030.0501</b>	Potenza assorbita apparecchio / Luminaire power consumption 18W	1,17
	<b>A14202.030.0501</b>	Flusso luminoso apparecchio / Luminaire luminous flux 1314lm	
	<b>A14217.030.0501</b>	2700K Ra>90 220-240V AC ON-OFF	
	<b>A14219.030.0501</b>	IP20	
	<b>A14201.030.0401</b>	Potenza assorbita apparecchio / Luminaire power consumption 18W	1,17
	<b>A14202.030.0401</b>	Flusso luminoso apparecchio / Luminaire luminous flux 1314lm	
	<b>A14217.030.0401</b>	3000K Ra>90 220-240V AC ON-OFF	
	<b>A14219.030.0401</b>	IP20	
	<b>A14201.030.0504</b>	Potenza assorbita apparecchio / Luminaire power consumption 20W	1,17
	<b>A14202.030.0504</b>	Flusso luminoso apparecchio / Luminaire luminous flux 1314lm	
	<b>A14217.030.0504</b>	2700K Ra>90 220-240V AC dimmable (phase cut)	
	<b>A14219.030.0504</b>	IP20	
	<b>A14201.030.0404</b>	Potenza assorbita apparecchio / Luminaire power consumption 20W	1,17
	<b>A14202.030.0404</b>	Flusso luminoso apparecchio / Luminaire luminous flux 1314lm	
	<b>A14217.030.0404</b>	3000K Ra>90 220-240V AC dimmable (phase cut)	
	<b>A14219.030.0404</b>	IP20	

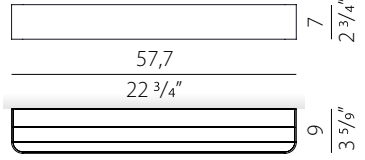
# TOY R

Enzo Panzeri 2024

	CODICE CODE	FONTI LUMINOSE LIGHT SOURCES	kg
	<b>A14201.045.0504</b> <b>A14202.045.0504</b> <b>A14217.045.0504</b> <b>A14219.045.0504</b> <b>A14230.045.0504</b>	Potenza assorbita apparecchio / Luminaire power consumption 26W Flusso luminoso apparecchio / Luminaire luminous flux 1971lm 2700K Ra>90 220-240V AC dimmable (phase cut)  IP20	1,67
	<b>A14201.045.0501</b> <b>A14202.045.0501</b> <b>A14217.045.0501</b> <b>A14219.045.0501</b> <b>A14230.045.0501</b>	Potenza assorbita apparecchio / Luminaire power consumption 26W Flusso luminoso apparecchio / Luminaire luminous flux 1971lm 2700K Ra>90 220-240V AC ON-OFF  IP20	1,67
	<b>A14201.045.0401</b> <b>A14202.045.0401</b> <b>A14217.045.0401</b> <b>A14219.045.0401</b> <b>A14230.045.0401</b>	Potenza assorbita apparecchio / Luminaire power consumption 26W Flusso luminoso apparecchio / Luminaire luminous flux 1971lm 3000K Ra>90 220-240V AC ON-OFF  IP20	1,67
	<b>A14201.045.0404</b> <b>A14202.045.0404</b> <b>A14217.045.0404</b> <b>A14219.045.0404</b> <b>A14230.045.0404</b>	Potenza assorbita apparecchio / Luminaire power consumption 26W Flusso luminoso apparecchio / Luminaire luminous flux 1971lm 3000K Ra>90 220-240V AC dimmable (phase cut)  IP20	1,67
	<b>A14201.060.0501</b> <b>A14202.060.0501</b> <b>A14217.060.0501</b> <b>A14219.060.0501</b> <b>A14230.060.0501</b>	Potenza assorbita apparecchio / Luminaire power consumption 34W Flusso luminoso apparecchio / Luminaire luminous flux 2628lm 2700K Ra>90 220-240V AC ON-OFF  IP20	2,17
	<b>A14201.060.0401</b> <b>A14202.060.0401</b> <b>A14217.060.0401</b> <b>A14219.060.0401</b> <b>A14230.060.0401</b>	Potenza assorbita apparecchio / Luminaire power consumption 34W Flusso luminoso apparecchio / Luminaire luminous flux 2628lm 3000K Ra>90 220-240V AC ON-OFF  IP20	2,17
	<b>A14201.060.0504</b> <b>A14202.060.0504</b> <b>A14217.060.0504</b> <b>A14219.060.0504</b> <b>A14230.060.0504</b>	Potenza assorbita apparecchio / Luminaire power consumption 34W Flusso luminoso apparecchio / Luminaire luminous flux 2628lm 2700K Ra>90 220-240V AC dimmable (phase cut)  IP20	2,17
	<b>A14201.060.0404</b> <b>A14202.060.0404</b> <b>A14217.060.0404</b> <b>A14219.060.0404</b> <b>A14230.060.0404</b>	Potenza assorbita apparecchio / Luminaire power consumption 34W Flusso luminoso apparecchio / Luminaire luminous flux 2628lm 3000K Ra>90 220-240V AC dimmable (phase cut)  IP20	2,17

Fotometrie disponibili [www.panzeri.it](http://www.panzeri.it) / Photometric data available at [www.panzeri.it](http://www.panzeri.it) **Disponibili a richiesta con elettrificazione DALI/Push DIM / Available on request with DALI/Push DIM power supply**

## CODICI COLORI DISPONIBILI / COLOUR CODES AVAILABLE

## Disponibili a richiesta / Available on request

<b>01</b> bianco white	<b>02</b> nero black	<b>17</b> bronzo bronze	<b>19</b> ottone satinato mat brass	<b>30</b> titanio titanium	<b>27</b> verde oliva materico textured olive green	<b>29</b> terracotta naturale materico textured natural terracotta
---------------------------	-------------------------	----------------------------	--	-------------------------------	--	---















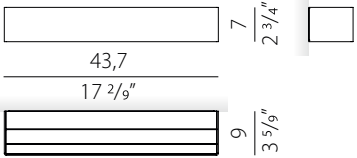



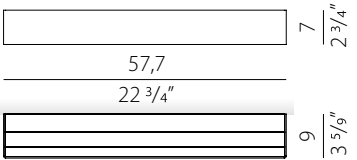

Lampada da parete biemissione che unisce minimalismo, geometria e alte prestazioni. La geometria del corpo in alluminio estruso indirizza il flusso luminoso verso il centro della stanza. La forma semplice, scandita dalle linee nette e precise e dagli spigoli definiti della cover esterna con accoppiamento magnetico, si adatta a varie tipologie di ambiente. Le diverse lunghezze disponibili rendono l'apparecchio adatto per installazioni singole e composizioni di più elementi, in corridoi, aree di passaggio e locali ampi. Disponibile in finitura bianca, nera, bronzo, ottone satinato e titanio. Disponibili a richiesta le finiture verde oliva materico e terracotta naturale materico.

Double-emission wall lamp that combines minimalism, geometry and high performance. The geometry of the extruded body directs the luminous flux towards the centre of the room. The simple shape, marked by the clear, precise lines and the defined edges of the external cover with magnetic coupling, adapts to various types of environment. The different available lengths make the fixture suitable for single installations and multi-element compositions, in corridors, transit areas and large ambiances. Available in white, black, bronze, mat brass and titanium finishes. Textured olive green and textured natural terracotta finishes available on request.

NEW	CODICE CODE	FONTI LUMINOSE LIGHT SOURCES	kg
	<b>A14101.015.0504</b> <b>A14102.015.0504</b> <b>A14117.015.0504</b> <b>A14119.015.0504</b> <b>A14130.015.0504</b>	Potenza assorbita apparecchio / Luminaire power consumption 10W Flusso luminoso apparecchio / Luminaire luminous flux 657lm 2700K Ra>90 220-240V AC dimmable (phase cut) IP20	0,85
	<b>A14101.015.0404</b> <b>A14102.015.0404</b> <b>A14117.015.0404</b> <b>A14119.015.0404</b> <b>A14130.015.0404</b>	Potenza assorbita apparecchio / Luminaire power consumption 10W Flusso luminoso apparecchio / Luminaire luminous flux 657lm 3000K Ra>90 220-240V AC dimmable (phase cut) IP20	0,85
	<b>A14101.030.0501</b> <b>A14102.030.0501</b> <b>A14117.030.0501</b> <b>A14119.030.0501</b> <b>A14130.030.0501</b>	Potenza assorbita apparecchio / Luminaire power consumption 18W Flusso luminoso apparecchio / Luminaire luminous flux 1314lm 2700K Ra>90 220-240V AC ON-OFF IP20	1,20
	<b>A14101.030.0401</b> <b>A14102.030.0401</b> <b>A14117.030.0401</b> <b>A14119.030.0401</b> <b>A14130.030.0401</b>	Potenza assorbita apparecchio / Luminaire power consumption 18W Flusso luminoso apparecchio / Luminaire luminous flux 1314lm 3000K Ra>90 220-240V AC ON-OFF IP20	1,20
	<b>A14101.030.0504</b> <b>A14102.030.0504</b> <b>A14117.030.0504</b> <b>A14119.030.0504</b> <b>A14130.030.0504</b>	Potenza assorbita apparecchio / Luminaire power consumption 20W Flusso luminoso apparecchio / Luminaire luminous flux 1314lm 2700K Ra>90 220-240V AC dimmable (phase cut) IP20	1,20
	<b>A14101.030.0404</b> <b>A14102.030.0404</b> <b>A14117.030.0404</b> <b>A14119.030.0404</b> <b>A14130.030.0404</b>	Potenza assorbita apparecchio / Luminaire power consumption 20W Flusso luminoso apparecchio / Luminaire luminous flux 1314lm 3000K Ra>90 220-240V AC dimmable (phase cut) IP20	1,20

# TOY S

Enzo Panzeri 2024

	CODICE CODE	FONTI LUMINOSE LIGHT SOURCES	kg
	 <b>A14101.045.0501</b>	Potenza assorbita apparecchio / Luminaire power consumption 26W	1,70
	<b>A14102.045.0501</b>	Flusso luminoso apparecchio / Luminaire luminous flux 1971lm	
	<b>A14117.045.0501</b>	2700K Ra>90 220-240V AC ON-OFF	
	<b>A14119.045.0501</b>	 <b>IP20</b>	
	 <b>A14101.045.0401</b>	Potenza assorbita apparecchio / Luminaire power consumption 26W	1,70
	<b>A14102.045.0401</b>	Flusso luminoso apparecchio / Luminaire luminous flux 1971lm	
	<b>A14117.045.0401</b>	3000K Ra>90 220-240V AC ON-OFF	
	<b>A14119.045.0401</b>	 <b>IP20</b>	
	 <b>A14101.045.0504</b>	Potenza assorbita apparecchio / Luminaire power consumption 26W	1,70
	<b>A14102.045.0504</b>	Flusso luminoso apparecchio / Luminaire luminous flux 1971lm	
	<b>A14117.045.0504</b>	2700K Ra>90 220-240V AC dimmable (phase cut)	
	<b>A14119.045.0504</b>	 <b>IP20</b>	
	 <b>A14101.045.0404</b>	Potenza assorbita apparecchio / Luminaire power consumption 26W	1,70
	<b>A14102.045.0404</b>	Flusso luminoso apparecchio / Luminaire luminous flux 1971lm	
	<b>A14117.045.0404</b>	3000K Ra>90 220-240V AC dimmable (phase cut)	
	<b>A14119.045.0404</b>	 <b>IP20</b>	
	 <b>A14101.060.0501</b>	Potenza assorbita apparecchio / Luminaire power consumption 34W	2,10
	<b>A14102.060.0501</b>	Flusso luminoso apparecchio / Luminaire luminous flux 2628lm	
	<b>A14117.060.0501</b>	2700K Ra>90 220-240V AC ON-OFF	
	<b>A14119.060.0501</b>	 <b>IP20</b>	
	 <b>A14101.060.0401</b>	Potenza assorbita apparecchio / Luminaire power consumption 34W	2,10
	<b>A14102.060.0401</b>	Flusso luminoso apparecchio / Luminaire luminous flux 2628lm	
	<b>A14117.060.0401</b>	3000K Ra>90 220-240V AC ON-OFF	
	<b>A14119.060.0401</b>	 <b>IP20</b>	
	 <b>A14101.060.0504</b>	Potenza assorbita apparecchio / Luminaire power consumption 34W	2,10
	<b>A14102.060.0504</b>	Flusso luminoso apparecchio / Luminaire luminous flux 2628lm	
	<b>A14117.060.0504</b>	2700K Ra>90 220-240V AC dimmable (phase cut)	
	<b>A14119.060.0504</b>	 <b>IP20</b>	
	 <b>A14101.060.0404</b>	Potenza assorbita apparecchio / Luminaire power consumption 34W	2,10
	<b>A14102.060.0404</b>	Flusso luminoso apparecchio / Luminaire luminous flux 2628lm	
	<b>A14117.060.0404</b>	3000K Ra>90 220-240V AC dimmable (phase cut)	
	<b>A14119.060.0404</b>	 <b>IP20</b>	

Fotometrie disponibili [www.panzeri.it](http://www.panzeri.it) / Photometric data available at [www.panzeri.it](http://www.panzeri.it) **Disponibili a richiesta con elettrificazione DALI/Push DIM / Available on request with DALI/Push DIM power supply**

## CODICI COLORI DISPONIBILI / COLOUR CODES AVAILABLE

## Disponibili a richiesta / Available on request

<b>01</b> bianco white	<b>02</b> nero black	<b>17</b> bronzo bronze	<b>19</b> ottone satinato mat brass	<b>30</b> titanio titanium	<b>27</b> verde oliva materico textured olive green	<b>29</b> terracotta naturale materico textured natural terracotta
---------------------------	-------------------------	----------------------------	--	-------------------------------	--	---





Lampada a sospensione, tavolo, parete/soffitto (disponibile anche a incasso) e terra in alluminio tornito con accensione ON-OFF e cavo trasparente. Tubino parete/soffitto è particolarmente adatta in applicazione alla testata del letto, sia in ambito residenziale che hospitality. Nella versione terra le sorgenti raddoppiano, il posizionamento sulla struttura a stelo è pensato per consentirne l'utilizzo anche come lampada da lettura. La versione tavolo è disponibile nella variante Tubino Plus con comando Step DIM a 5 regolazioni dell'intensità luminosa in finitura champagne, bronzo o titanio con cavo di alimentazione tra la testa e la struttura in tessuto colorato.

Suspension, table, wall / ceiling (also available as recessed) and floor lamp in turned aluminium with ON-OFF ignition and transparent cable. Tubino wall / ceiling can be easily applied to the bedhead, both in residential and hospitality projects. In the floor version the lighting sources double, the positioning on the stem structure is designed to allow an use also as a reading lamp. The table version is also available as Tubino plus with Step DIM control and 5 light intensity settings. Champagne bronze and titanium finishes with fabric colored cable between the head and the structure.

CODICE CODE	FONTI LUMINOSE LIGHT SOURCES	kg
-------------	------------------------------	----

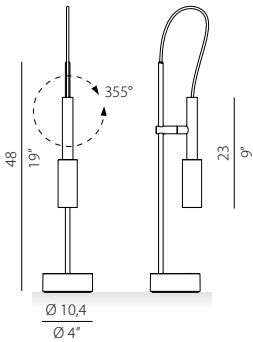

**C07301.001.0501**  
**C07306.001.0501**

Potenza assorbita apparecchio / Luminaire power consumption 6,5W 1,42  
 Flusso luminoso apparecchio / Luminaire luminous flux 339lm  
 2700K Ra>90 220-240V AC ON-OFF

**IP20**  
 Cavo trasparente  
 Transparent cable

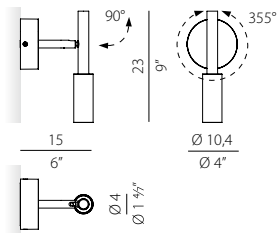

**A07301.001.0501**  
**A07305.001.0501**  
**A07306.001.0501**  
**A07317.001.0501**  
**A07330.001.0501**

Potenza assorbita apparecchio / Luminaire power consumption 6,5W 0,62  
 Flusso luminoso apparecchio / Luminaire luminous flux 339lm  
 2700K Ra>90 220-240V AC ON-OFF

**IP20**

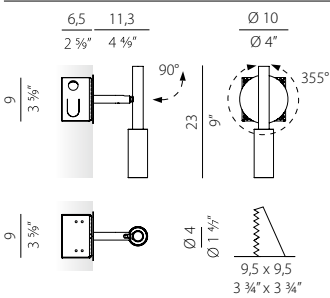

**X07301.001.0501**  
**X07305.001.0501**  
**X07306.001.0501**  
**X07317.001.0501**  
**X07330.001.0501**

Potenza assorbita apparecchio / Luminaire power consumption 6,5W 1,09  
 Flusso luminoso apparecchio / Luminaire luminous flux 339lm  
 2700K Ra>90 220-240V AC ON-OFF

**IP20**

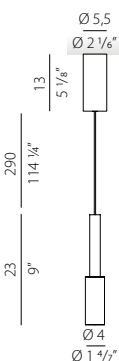

**L07301.001.0501**  
**L07305.001.0501**  
**L07306.001.0501**  
**L07317.001.0501**  
**L07330.001.0501**

Potenza assorbita apparecchio / Luminaire power consumption 6,5W 0,51  
 Flusso luminoso apparecchio / Luminaire luminous flux 339lm  
 2700K Ra>90 220-240V AC ON-OFF

**IP20**  
 Cavo trasparente  
 Transparent cable



# TUBINO

Matteo Thun 2019/2020

Registered Design

	CODICE CODE	FONTI LUMINOSE LIGHT SOURCES	kg
	<b>T07301.002.0501</b>	Potenza assorbita apparecchio / Luminaire power consumption 13W	4,49
	<b>T07306.002.0501</b>	Flusso luminoso apparecchio / Luminaire luminous flux 678lm 2700K Ra>90 220-240V AC ON-OFF	
		<b>IP20</b> Cavo trasparente Transparent cable	

Fotometrie disponibili [www.panzeri.it](http://www.panzeri.it) / Photometric data available at [www.panzeri.it](http://www.panzeri.it)

## CODICI COLORI DISPONIBILI / COLOUR CODES AVAILABLE

- 01** bianco  
white
- 05** champagne  
champagne
- 06** nero satinato  
mat black
- 17** bronzo  
bronze
- 30** titanio  
titanium





# TUBINO

Matteo Thun 2019

Registered Design





Lampada da tavolo in alluminio tornito. Tubino Plus è disponibile in versione con comando Step DIM a 5 regolazioni di intensità luminosa in finitura champagne, bronzo e titanio con cavo di alimentazione tra la testa e la struttura in tessuto.

Aluminium table in turned aluminium. Tubino Plus is available with Step DIM control with 5 light intensity settings in champagne, bronze and titanium finish with fabric cable between the head and the structure.

TUBINO PLUS

CODICE CODE	FONTI LUMINOSE LIGHT SOURCES	kg
-------------	------------------------------	----

 **C07305.001.0509**  
 **C07317.001.0509**  
 **C07330.001.0509**

Potenza assorbita apparecchio / Luminaire power consumption 6,5W  
 Flusso luminoso apparecchio / Luminaire luminous flux 339lm  
 2700K Ra>90 220-240V AC dimmable (Step DIM)

 **IP20** 

Finitura champagne con cavo in tessuto color champagne, bronzo con cavo in tessuto bourdeaux, titanio con cavo in tessuto verde. Interruttore incluso  
 Champagne with champagne fabric cable, bronze with bourdeaux fabric cable, titanium with green fabric cable. Switch included

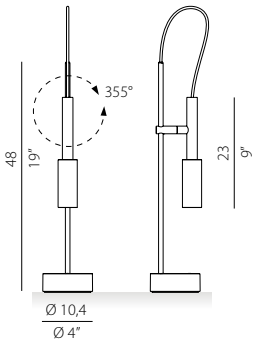

Fotometrie disponibili [www.panzeri.it](http://www.panzeri.it) / Photometric data available at [www.panzeri.it](http://www.panzeri.it)

## CODICI COLORI DISPONIBILI / COLOUR CODES AVAILABLE

**05** champagne  
champagne

**17** bronzo  
bronze

**30** titanio  
titanium



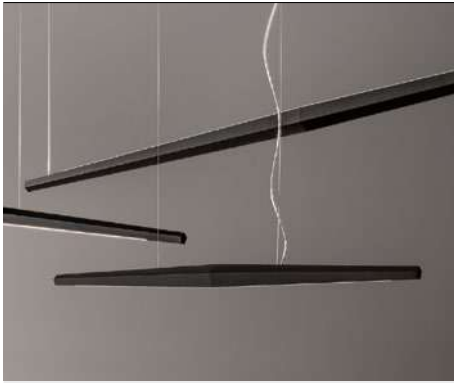

Lampada a sospensione e da terra con sezione pentagonale in alluminio piegato e inciso. Sorgente luminosa composta da modulo LED e dimmerazione di serie DALI/Push DIM integrata nel corpo della lampada tramite driver ultra-flat di ultima generazione. Versione a sospensione disponibile in due lunghezze (120 e 210cm) a luce diretta. Disponibile versione a sospensione a luce indiretta, ideale per creare composizioni in combinazione con la versione a luce diretta. Disponibile versione da terra con base realizzata in metallo tagliato a laser, piegato, e verniciato. Finitura con vernice poliaccrilica in bianco o nero. Ideale per uffici, zone living, e in composizione per arredare grandi spazi.

Suspension and floor lamp with pentagonal section in folded and carved aluminum. Light source made of LED module and DALI/Push DIM ultra-flat driver integrated in the suspended body of the fitting. Suspended version available in two dimensions (120 and 210cm) with direct down light. Availability of an indirect up light suspension version, ideal to create compositions in combination with the direct down light version. Floor version with base in metal laser-cut, bent and painted. Finished in polyacrylic paint in white or black. Ideal for offices, living areas, and in compositions to furnish large spaces.

	CODICE CODE	FONTI LUMINOSE LIGHT SOURCES	kg
	<b>L02001.120.0402</b> <b>L02002.120.0402</b>	Potenza assorbita apparecchio / Luminaire power consumption 23W Flusso luminoso apparecchio / Luminaire luminous flux 1188lm 3000K Ra>90 220-240V AC dimmable (DALI/Push DIM) IP40	1,45
	<b>L02001.210.0402</b> <b>L02002.210.0402</b>	Potenza assorbita apparecchio / Luminaire power consumption 44W Flusso luminoso apparecchio / Luminaire luminous flux 2376lm 3000K Ra>90 220-240V AC dimmable (DALI/Push DIM) IP40	2,80
	<b>L02101.210.0402</b> <b>L02102.210.0402</b>	Potenza assorbita apparecchio / Luminaire power consumption 44W Flusso luminoso apparecchio / Luminaire luminous flux 2376lm 3000K Ra>90 220-240V AC dimmable (DALI/Push DIM) IP40	3,00
	<b>T02001.210.0402</b> <b>T02002.210.0402</b>	Potenza assorbita apparecchio / Luminaire power consumption 44W Flusso luminoso apparecchio / Luminaire luminous flux 2376lm 3000K Ra>90 220-240V AC dimmable (Push DIM) IP20	4,95 6,94

Fotometrie disponibili [www.panzeri.it](http://www.panzeri.it) / Photometric data available at [www.panzeri.it](http://www.panzeri.it)

CODICI COLORI DISPONIBILI / COLOUR CODES AVAILABLE

Disponibili a richiesta LED 2700K / On request 2700K LED available

- 01** bianco / white
- 02** nero / black



red dot award 2018 winner



Suspensioni in vetro soffiato bianco satinato o decorato nero ø 40cm, ø 50cm e ø 60cm con diffusore in lastra di vetro. Montature in grigio metallizzato.

Suspensions in white blown or black painted glass, ø 40cm, ø 50cm and ø 60cm with glass sheet as diffuser. Fittings in metallized grey metal.

	CODICE CODE	FONTI LUMINOSE LIGHT SOURCES	kg
	<b>L07631.040.0000</b>	LED retrofit bulb E27 (L max 120mm - Ø max 65mm) max 150W E27 <b>IP20</b>	3,96
	<b>L07633.040.0000</b>	LED retrofit bulb E27 (L max 120mm - Ø max 65mm) max 150W E27 <b>IP20</b>	3,96
	<b>L07631.050.0000</b>	LED retrofit bulb E27 (L max 120mm - Ø max 65mm) max 150W E27 <b>IP20</b>	5,74
	<b>L07633.050.0000</b>	LED retrofit bulb E27 (L max 120mm - Ø max 65mm) max 150W E27 <b>IP20</b>	5,74
	<b>L07631.060.0402</b>	Potenza assorbita apparecchio / Luminaire power consumption 40W Flusso luminoso apparecchio / Luminaire luminous flux 3587lm 3000K Ra>90 220-240V AC dimmable (DALI/Push DIM) <b>IP20</b>	8,38
	<b>L07633.060.0402</b>	Potenza assorbita apparecchio / Luminaire power consumption 40W Flusso luminoso apparecchio / Luminaire luminous flux 3587lm 3000K Ra>90 220-240V AC dimmable (DALI/Push DIM) <b>IP20</b>	8,38
	<b>L07631.060.0000</b>	3x LED retrofit bulb E27 (L max 140mm - Ø max 65mm) 3x max 100W E27 <b>IP20</b>	8,38
	<b>L07633.060.0000</b>	3x LED retrofit bulb E27 (L max 140mm - Ø max 65mm) 3x max 100W E27 <b>IP20</b>	8,38

Fotometrie disponibili [www.panzeri.it](http://www.panzeri.it) / Photometric data available at [www.panzeri.it](http://www.panzeri.it)

### CODICI COLORI DISPONIBILI / COLOUR CODES AVAILABLE

**31** grigio metallizzato/diffusore nero  
metallized grey/black diffuser

**33** grigio metallizzato/diffusore bianco  
metallized grey/white diffuser





Lampada a parete costituita da una barra in ottone. Luce indiretta emessa attraverso schermo in policarbonato semiopale. Fonte luminosa costituita da modulo LED. Struttura rifinita con vernice poliaccrilica in colore bianco, nero, bronzo, ottone satinato o cromata. Due versioni disponibili: montatura incassata nel muro o montatura esterna. Nessun elemento di fissaggio a vista. Ideale per ambienti residenziali o moderne strutture hospitality.

Wall lamp in brass bar. Indirect light emitted through a semi-opal polycarbonate screen. LED module. Fitting in white, black, bronze, mat brass polyacrylic paint or in chrome version. Two available versions: recessed mounting in the wall or external mounting. No visible fastening element. Ideal for residential spaces or modern hospitality facilities.

	CODICE CODE	FONTI LUMINOSE LIGHT SOURCES	kg
	<b>A07201.000.0401</b>	Potenza assorbita apparecchio / Luminaire power consumption 13W	0,59
	<b>A07202.000.0401</b>	Flusso luminoso apparecchio / Luminaire luminous flux 1046lm	
	<b>A07217.000.0401</b>	3000K Ra>90 220-240V AC ON-OFF	
	<b>A07219.000.0401</b>	IP20	
	<b>A07222.000.0401</b>		

	<b>X07201.000.0401</b>	Potenza assorbita apparecchio / Luminaire power consumption 13W	0,59
	<b>X07202.000.0401</b>	Flusso luminoso apparecchio / Luminaire luminous flux 1046lm	
	<b>X07217.000.0401</b>	3000K Ra>90 220-240V AC ON-OFF	
	<b>X07219.000.0401</b>	IP20	
	<b>X07222.000.0401</b>		

Fotometrie disponibili [www.panzeri.it](http://www.panzeri.it) / Photometric data available at [www.panzeri.it](http://www.panzeri.it)

**CODICI COLORI DISPONIBILI / COLOUR CODES AVAILABLE**

- 01** bianco  
white
- 02** nero  
black
- 17** bronzo  
bronze
- 19** ottone satinato  
mat brass
- 22** cromo  
chrome





# ZERO LINE

Enzo Panzeri 2024



Lampade da parete/soffitto in metallo bianco, nero, cromo, bronzo, ottone satinato e foglia oro, con riflettore coordinato, complete di LED e driver.

Wall and ceiling lamps in white, black, chrome, bronze, satin brass and gold leaf, with matching reflector, complete with LED and driver.

NEW	CODICE CODE	FONTI LUMINOSE LIGHT SOURCES	kg
	<b>A03601.050.0501</b>	Potenza assorbita apparecchio / Luminaire power consumption 12,2W	0,92
	<b>A03602.050.0501</b>	Flusso luminoso apparecchio / Luminaire luminous flux 640lm	
	<b>A03617.050.0501</b>	2700K Ra>90 220-240V AC ON-OFF	
	<b>A03619.050.0501</b>	IP20	
	<b>A03621.050.0501</b>	Riflettore satinato / Satin reflector	
	<b>A03622.050.0501</b>	Potenza assorbita apparecchio / Luminaire power consumption 12,2W	0,92
	<b>A03602.050.0502</b>	Flusso luminoso apparecchio / Luminaire luminous flux 786lm	
	<b>A03617.050.0502</b>	2700K Ra>90 220-240V AC ON-OFF	
	<b>A03619.050.0502</b>	IP20	
	<b>A03621.050.0502</b>	Riflettore satinato / Satin reflector	
	<b>A03622.050.0502</b>	Potenza assorbita apparecchio / Luminaire power consumption 12,2W	0,92
	<b>A03602.050.0502</b>	Flusso luminoso apparecchio / Luminaire luminous flux 786lm	
	<b>A03617.050.0502</b>	2700K Ra>90 220-240V AC dimmable (DALI/Push DIM)	
	<b>A03619.050.0502</b>	IP20	
	<b>A03621.050.0502</b>	Riflettore satinato / Satin reflector	
	<b>A03601.100.0501</b>	Potenza assorbita apparecchio / Luminaire power consumption 22,2W	1,58
	<b>A03602.100.0501</b>	Flusso luminoso apparecchio / Luminaire luminous flux 1280lm	
	<b>A03617.100.0501</b>	2700K Ra>90 220-240V AC ON-OFF	
	<b>A03619.100.0501</b>	IP20	
	<b>A03621.100.0501</b>	Riflettore satinato / Satin reflector	
	<b>A03622.100.0501</b>	Potenza assorbita apparecchio / Luminaire power consumption 22,2W	1,58
	<b>A03602.100.0502</b>	Flusso luminoso apparecchio / Luminaire luminous flux 1572lm	
	<b>A03617.100.0502</b>	2700K Ra>90 220-240V AC ON-OFF	
	<b>A03619.100.0502</b>	IP20	
	<b>A03621.100.0502</b>	Riflettore satinato / Satin reflector	
	<b>A03622.100.0502</b>	Potenza assorbita apparecchio / Luminaire power consumption 22,2W	1,58
	<b>A03602.100.0502</b>	Flusso luminoso apparecchio / Luminaire luminous flux 1572lm	
	<b>A03617.100.0502</b>	2700K Ra>90 220-240V AC dimmable (DALI/Push DIM)	
	<b>A03619.100.0502</b>	IP20	
	<b>A03621.100.0502</b>	Riflettore satinato / Satin reflector	
	<b>A03622.100.0502</b>	Potenza assorbita apparecchio / Luminaire power consumption 22,2W	1,58
	<b>A03602.100.0502</b>	Flusso luminoso apparecchio / Luminaire luminous flux 1572lm	
	<b>A03617.100.0502</b>	2700K Ra>90 220-240V AC dimmable (DALI/Push DIM)	
	<b>A03619.100.0502</b>	IP20	
	<b>A03621.100.0502</b>	Riflettore satinato / Satin reflector	
	<b>A03622.100.0502</b>	Potenza assorbita apparecchio / Luminaire power consumption 22,2W	1,58
	<b>A03602.100.0502</b>	Flusso luminoso apparecchio / Luminaire luminous flux 1572lm	
	<b>A03617.100.0502</b>	2700K Ra>90 220-240V AC dimmable (DALI/Push DIM)	
	<b>A03619.100.0502</b>	IP20	
	<b>A03621.100.0502</b>	Riflettore satinato / Satin reflector	
	<b>A03622.100.0502</b>	Potenza assorbita apparecchio / Luminaire power consumption 22,2W	1,58
	<b>A03602.100.0502</b>	Flusso luminoso apparecchio / Luminaire luminous flux 1572lm	
	<b>A03617.100.0502</b>	2700K Ra>90 220-240V AC dimmable (DALI/Push DIM)	
	<b>A03619.100.0502</b>	IP20	
	<b>A03621.100.0502</b>	Riflettore satinato / Satin reflector	
	<b>A03622.100.0502</b>	Potenza assorbita apparecchio / Luminaire power consumption 22,2W	1,58
	<b>A03602.100.0502</b>	Flusso luminoso apparecchio / Luminaire luminous flux 1572lm	
	<b>A03617.100.0502</b>	2700K Ra>90 220-240V AC dimmable (DALI/Push DIM)	
	<b>A03619.100.0502</b>	IP20	
	<b>A03621.100.0502</b>	Riflettore satinato / Satin reflector	

Fotometrie disponibili [www.panzeri.it](http://www.panzeri.it) / Photometric data available at [www.panzeri.it](http://www.panzeri.it)

Disponibili a richiesta LED 3000K / On request 3000K LED available

## CODICI COLORI DISPONIBILI / COLOUR CODES AVAILABLE

<b>01</b> bianco white	<b>02</b> nero black	<b>17</b> bronzo bronze	<b>19</b> ottone satinato mat brass	<b>21</b> foglia oro gold leaf	<b>22</b> cromo chrome
---------------------------	-------------------------	----------------------------	--	-----------------------------------	---------------------------



# ZERO SHAPES

Enzo Panzeri 2022



Lampada a sospensione orizzontale in alluminio estruso curvato, con schermo in policarbonato opale. Emissione interna attraverso modulo LED e tecnologia ZigBee di serie su tutte le versioni inserita nel rosone. Anello rifinito con vernice poliaccrilica color bianco, nero, titanio, bronzo e ottone satinato. Ideale per ambienti residenziali e zone living.

Horizontal suspension lamp in extruded curved aluminum, with opal polycarbonate screen. Emission on the internal side provided by LED modules with ZigBee technology integrated into the canopy. Polyacrylic paint white, black, titanium, bronze and mat brass finishes are available. Ideal for residential spaces and living areas.

CODICE CODE	FONTE LUMINOSE LIGHT SOURCES	kg
-------------	------------------------------	----

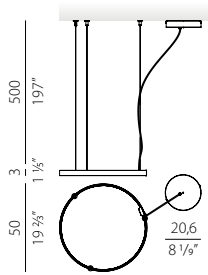

- L03301.050.0523**
- L03302.050.0523**
- L03317.050.0523**
- L03319.050.0523**
- L03330.050.0523**

Potenza assorbita apparecchio / Luminaire power consumption 25W  
 Flusso luminoso apparecchio / Luminaire luminous flux 2039lm  
 2700K Ra>90 220-240V AC dimmable (ZigBee)

IP20

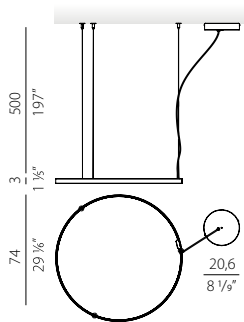

- L03301.075.0523**
- L03302.075.0523**
- L03317.075.0523**
- L03319.075.0523**
- L03330.075.0523**

Potenza assorbita apparecchio / Luminaire power consumption 36W  
 Flusso luminoso apparecchio / Luminaire luminous flux 3059lm  
 2700K Ra>90 220-240V AC dimmable (ZigBee)

IP20

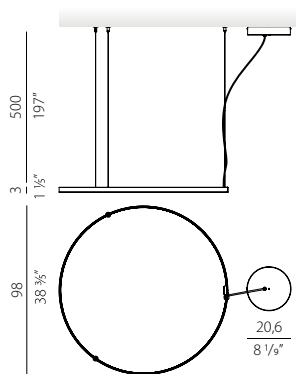

- L03301.100.0523**
- L03302.100.0523**
- L03317.100.0523**
- L03319.100.0523**
- L03330.100.0523**

Potenza assorbita apparecchio / Luminaire power consumption 47W  
 Flusso luminoso apparecchio / Luminaire luminous flux 4079lm  
 2700K Ra>90 220-240V AC dimmable (ZigBee)

IP20



### YCO.T001

Telecomando per dispositivi wireless ZigBee, per accensione/spengimento e regolazione di 4 gruppi di massimo 30 corpi illuminanti.  
 Remote controller for ZigBee wireless devices, supporting switch and dimming control of 4 groups with up to 30 lighting fixtures maximum.

Fotometrie disponibili [www.panzeri.it](http://www.panzeri.it) / Photometric data available at [www.panzeri.it](http://www.panzeri.it)

### CODICI COLORI DISPONIBILI / COLOUR CODES AVAILABLE

- 01** bianco white
- 02** nero black
- 17** bronzo bronze
- 19** ottone satinato mat brass
- 30** titanio titanium

# ZERO ROUND SMART

Zero Round Smart è collegabile facilmente alle reti domestiche esistenti e non richiede modifiche all'impianto elettrico. Accensione, spegnimento e regolazione della luce possono avvenire in diversi modi, tramite telecomando, smartphone, assistente vocale, ... Di seguito alcuni esempi di configurazioni possibili.

Zero Round Smart could be easily connected to existing home networks and does not require modification to electrical system. Switching on, switching off and dimming of the light could be obtained in various ways, through remote control, smartphone, voice assistant... As follow some examples of possible configurations.



L'apparecchio d'illuminazione può essere controllato grazie al telecomando (accessorio).  
**Non richiede una connessione internet o modifiche all'impianto elettrico.**

Lighting fixtures could be controlled by remote control (accessory).  
**It does not require an internet connection or modifications to the electrical system.**



L'apparecchio d'illuminazione può essere controllato tramite assistente vocale e altri dispositivi di controllo smart, come smartphone, ecc. Necessita di una connessione internet e di un hub Zigbee\* (ad esempio Philips Hue Bridge v.2.0\*, raccomandato). Possibilità di controllo anche tramite telecomando.  
**Non sono necessarie modifiche all'impianto elettrico.**

Lighting fixtures could be controlled by voice assistant and other smart control devices, such as smartphones, etc. Internet connection and Zigbee\* hub required (e.g. Philips Hue Bridge v.2.0\*, recommended). Possibility of control also by remote control.  
**Modifications to the electrical system not required.**

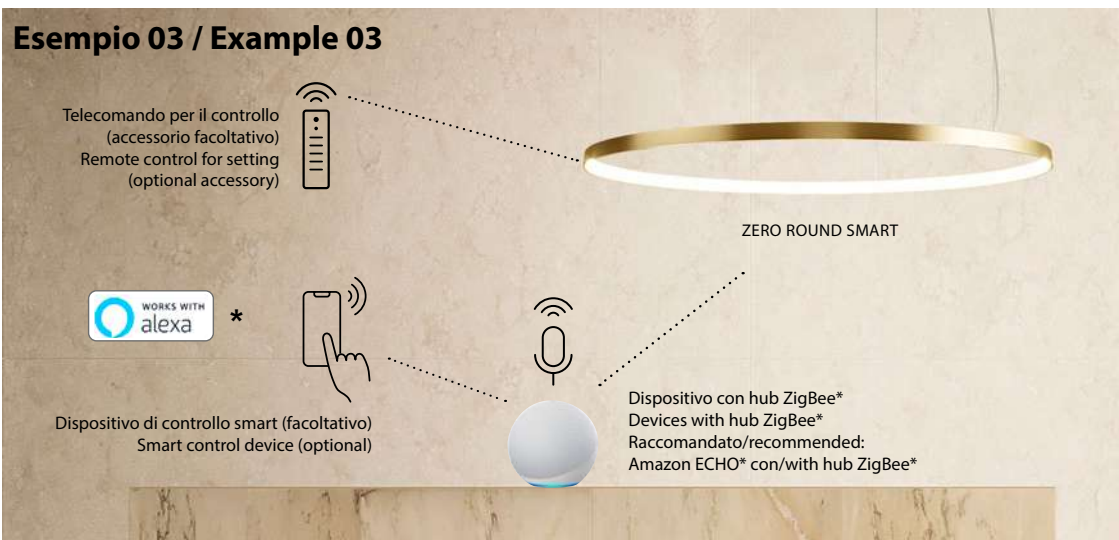

L'apparecchio d'illuminazione può essere controllato tramite assistente vocale e dispositivi di controllo smart, come smartphone, ecc. Necessita di una connessione internet Wi-Fi e di un assistente vocale con hub ZigBee\* integrato (Amazon Echo\* con hub ZigBee\* raccomandato). Possibilità di controllo anche tramite telecomando.  
**Non sono necessarie modifiche all'impianto elettrico.**

Lighting fixtures could be controlled by voice assistant and smart control devices, such as smartphones, etc. Wi-Fi internet connection and voice assistant with integrated ZigBee\* hub required (Amazon Echo\* with hub ZigBee\* recommended). Possibility of control also by remote control.  
**Modifications to the electrical system not required.**

\*ZigBee, Philips Hue Bridge, Amazon Echo, Alexa, Hey Google e Apple HomeKit sono marchi registrati di terzi senza alcun collegamento con Panzeri Carlo s.r.l.  
\*ZigBee, Philips Hue Bridge, Amazon Echo, Alexa, Hey Google e Apple HomeKit are registered trademarks without any relationship with Panzeri Carlo s.r.l.





# ZERO SHAPES

Enzo Panzeri 2018



Lampada a sospensione orizzontale, a parete e a soffitto in alluminio estruso curvato, con schermo in policarbonato opale. Emissione interna attraverso modulo LED e tecnologia DALI/Push DIM di serie su tutte le versioni inserita nel rosone. Anello rifinito con vernice poliaccrilica color bianco, nero, titanio, bronzo e ottone satinato. Disponibilità di rosone per installazioni singole e per composizioni multiple da ordinare separatamente. Ideale per uffici, hall, zone living, grandi spazi, anche in abbinamento con Zero Round Acoustic e Arena Acoustic.

Horizontal suspension lamp, wall and ceiling lamp in extruded curved aluminum, with opal polycarbonate screen. Emission on the internal side provided by LED modules with technology DALI/Push DIM integrated into the canopy. Polyacrilic paint white, black, titanium, bronze and mat brass finishes are available. Canopies for single and multiple configurations with Zero Ellipse and Zero Square are available, to be ordered separately. Ideal for offices, halls, living, and public spaces, also combined with Zero Round Acoustic and Arena Acoustic.

CODICE CODE	FONTI LUMINOSE LIGHT SOURCES	kg
-------------	------------------------------	----

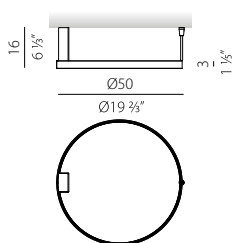

**P03301.050.0502**  
**P03302.050.0502**  
**P03317.050.0502**  
**P03319.050.0502**  
**P03330.050.0502**

Potenza assorbita apparecchio / Luminaire power consumption 29W  
 Flusso luminoso apparecchio / Luminaire luminous flux 2039lm  
 2700K Ra>90 220-240V AC dimmable (DALI/Push DIM)

IP20

1,41



**P03301.050.0402**  
**P03302.050.0402**  
**P03317.050.0402**  
**P03319.050.0402**  
**P03330.050.0402**

Potenza assorbita apparecchio / Luminaire power consumption 29W  
 Flusso luminoso apparecchio / Luminaire luminous flux 2039lm  
 3000K Ra>90 220-240V AC dimmable (DALI/Push DIM)

IP20

1,41

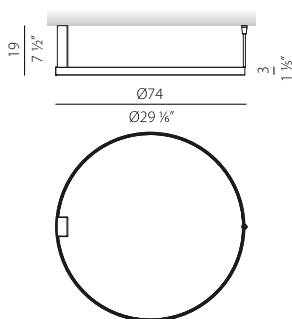

**P03301.075.0502**  
**P03302.075.0502**  
**P03317.075.0502**  
**P03319.075.0502**  
**P03330.075.0502**

Potenza assorbita apparecchio / Luminaire power consumption 42W  
 Flusso luminoso apparecchio / Luminaire luminous flux 3059lm  
 2700K Ra>90 220-240V AC dimmable (DALI/Push DIM)

IP20

1,80



**P03301.075.0402**  
**P03302.075.0402**  
**P03317.075.0402**  
**P03319.075.0402**  
**P03330.075.0402**

Potenza assorbita apparecchio / Luminaire power consumption 42W  
 Flusso luminoso apparecchio / Luminaire luminous flux 3059lm  
 3000K Ra>90 220-240V AC dimmable (DALI/Push DIM)

IP20

1,80

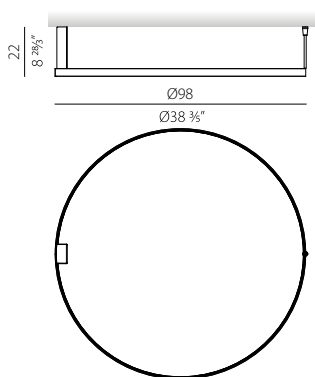

**P03301.100.0502**  
**P03302.100.0502**  
**P03317.100.0502**  
**P03319.100.0502**  
**P03330.100.0502**

Potenza assorbita apparecchio / Luminaire power consumption 54W  
 Flusso luminoso apparecchio / Luminaire luminous flux 4079lm  
 2700K Ra>90 220-240V AC dimmable (DALI/Push DIM)

IP20

2,06



**P03301.100.0402**  
**P03302.100.0402**  
**P03317.100.0402**  
**P03319.100.0402**  
**P03330.100.0402**

Potenza assorbita apparecchio / Luminaire power consumption 54W  
 Flusso luminoso apparecchio / Luminaire luminous flux 4079lm  
 3000K Ra>90 220-240V AC dimmable (DALI/Push DIM)

IP20

2,06

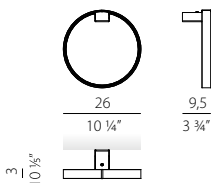

**A03301.025.0501**  
**A03302.025.0501**  
**A03317.025.0501**  
**A03319.025.0501**  
**A03330.025.0501**

Potenza assorbita apparecchio / Luminaire power consumption 13W  
 Flusso luminoso apparecchio / Luminaire luminous flux 796lm  
 2700K Ra>90 220-240V AC ON-OFF

IP40

0,62



**A03301.025.0401**  
**A03302.025.0401**  
**A03317.025.0401**  
**A03319.025.0401**  
**A03330.025.0401**

Potenza assorbita apparecchio / Luminaire power consumption 13W  
 Flusso luminoso apparecchio / Luminaire luminous flux 796lm  
 3000K Ra>90 220-240V AC ON-OFF

IP40

0,62

# ZERO SHAPES

Enzo Panzeri 2018

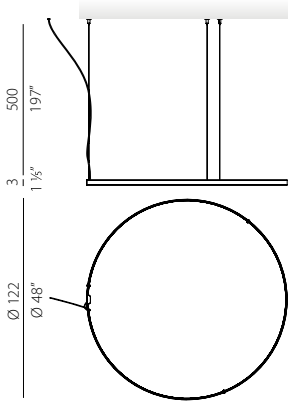
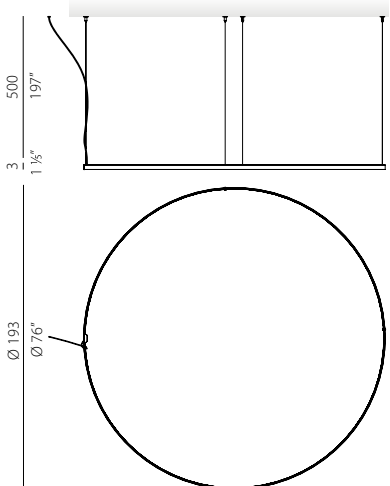
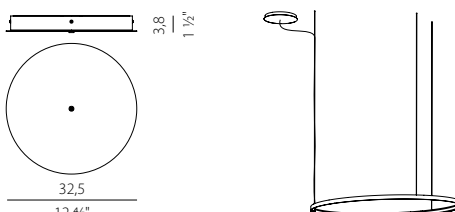
	CODICE CODE	FONTI LUMINOSE LIGHT SOURCES	kg
	<b>M10301.125.0510</b> <b>M10302.125.0510</b> <b>M10317.125.0510</b> <b>M10319.125.0510</b> <b>M10330.125.0510</b>	Potenza assorbita apparecchio / Luminaire power consumption 62W Flusso luminoso apparecchio / Luminaire luminous flux 5099lm 2700K Ra>90 24V DC <b>LED IP20</b>	1,50
	<b>M10301.125.0410</b> <b>M10302.125.0410</b> <b>M10317.125.0410</b> <b>M10319.125.0410</b> <b>M10330.125.0410</b>	Potenza assorbita apparecchio / Luminaire power consumption 62W Flusso luminoso apparecchio / Luminaire luminous flux 5099lm 3000K Ra>90 24V DC <b>LED IP20</b>	1,50
	<b>M10301.150.0510</b> <b>M10302.150.0510</b> <b>M10317.150.0510</b> <b>M10319.150.0510</b> <b>M10330.150.0510</b>	Potenza assorbita apparecchio / Luminaire power consumption 71W Flusso luminoso apparecchio / Luminaire luminous flux 6120lm 2700K Ra>90 24V DC <b>LED IP20</b>	1,58
	<b>M10301.150.0410</b> <b>M10302.150.0410</b> <b>M10317.150.0410</b> <b>M10319.150.0410</b> <b>M10330.150.0410</b>	Potenza assorbita apparecchio / Luminaire power consumption 71W Flusso luminoso apparecchio / Luminaire luminous flux 6120lm 3000K Ra>90 24V DC <b>LED IP20</b>	1,58
	<b>M10301.200.0510</b> <b>M10302.200.0510</b> <b>M10317.200.0510</b> <b>M10319.200.0510</b> <b>M10330.200.0510</b>	Potenza assorbita apparecchio / Luminaire power consumption 88W Flusso luminoso apparecchio / Luminaire luminous flux 8158lm 2700K Ra>90 24V DC <b>LED IP20</b>	2,34
	<b>M10301.200.0410</b> <b>M10302.200.0410</b> <b>M10317.200.0410</b> <b>M10319.200.0410</b> <b>M10330.200.0410</b>	Potenza assorbita apparecchio / Luminaire power consumption 88W Flusso luminoso apparecchio / Luminaire luminous flux 8158lm 3000K Ra>90 24V DC <b>LED IP20</b>	2,34
	<b>XM10301.521.0002</b> <b>XM10302.521.0002</b> <b>XM10317.521.0002</b> <b>XM10319.521.0002</b> <b>XM10330.521.0002</b>	Rosone per alimentazione di 1 modello Zero Round 125 - Zero Round 150 - Zero Round 200, con driver DALI/Push DIM. Canopy for power supply of 1 Zero Round 125 - Zero Round 150 - Zero Round 200 model, with DALI/Push DIM driver. dimmable (DALI/Push DIM)	2,56
			

# ZERO SHAPES

Enzo Panzeri 2018

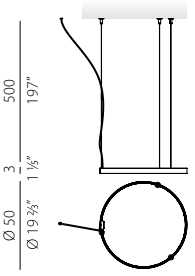
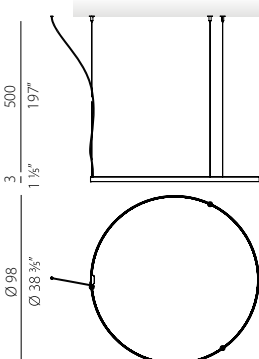
	CODICE CODE	FONTI LUMINOSE LIGHT SOURCES	kg
	<b>M03301.050.0510</b> <b>M03302.050.0510</b> <b>M03317.050.0510</b> <b>M03319.050.0510</b> <b>M03330.050.0510</b>	Potenza assorbita apparecchio / Luminaire power consumption 25W Flusso luminoso apparecchio / Luminaire luminous flux 2039lm 2700K Ra>90 24V DC <b>LED IP20</b>	0,83
	<b>M03301.050.0410</b> <b>M03302.050.0410</b> <b>M03317.050.0410</b> <b>M03319.050.0410</b> <b>M03330.050.0410</b>	Potenza assorbita apparecchio / Luminaire power consumption 25W Flusso luminoso apparecchio / Luminaire luminous flux 2039lm 3000K Ra>90 24V DC <b>LED IP20</b>	0,83
	<b>M03301.075.0510</b> <b>M03302.075.0510</b> <b>M03317.075.0510</b> <b>M03319.075.0510</b> <b>M03330.075.0510</b>	Potenza assorbita apparecchio / Luminaire power consumption 36W Flusso luminoso apparecchio / Luminaire luminous flux 3059lm 2700K Ra>90 24V DC <b>LED IP20</b>	1,12
	<b>M03301.075.0410</b> <b>M03302.075.0410</b> <b>M03317.075.0410</b> <b>M03319.075.0410</b> <b>M03330.075.0410</b>	Potenza assorbita apparecchio / Luminaire power consumption 36W Flusso luminoso apparecchio / Luminaire luminous flux 3059lm 3000K Ra>90 24V DC <b>LED IP20</b>	1,12
	<b>M03301.100.0510</b> <b>M03302.100.0510</b> <b>M03317.100.0510</b> <b>M03319.100.0510</b> <b>M03330.100.0510</b>	Potenza assorbita apparecchio / Luminaire power consumption 47W Flusso luminoso apparecchio / Luminaire luminous flux 4079lm 2700K Ra>90 24V DC <b>LED IP20</b>	1,43
	<b>M03301.100.0410</b> <b>M03302.100.0410</b> <b>M03317.100.0410</b> <b>M03319.100.0410</b> <b>M03330.100.0410</b>	Potenza assorbita apparecchio / Luminaire power consumption 47W Flusso luminoso apparecchio / Luminaire luminous flux 4079lm 3000K Ra>90 24V DC <b>LED IP20</b>	1,43

Fotometrie disponibili [www.panzeri.it](http://www.panzeri.it) / Photometric data available at [www.panzeri.it](http://www.panzeri.it)

## CODICI COLORI DISPONIBILI / COLOUR CODES AVAILABLE

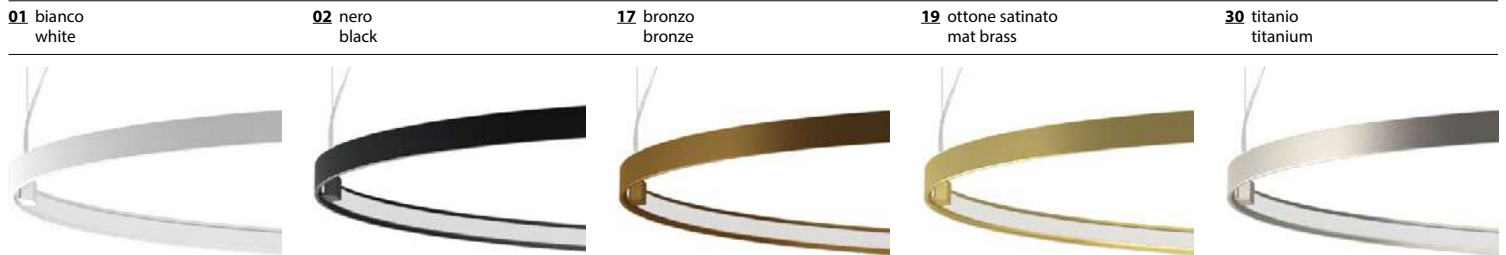

**ROSONI PER ZERO SHAPES A PAGINA 94 / CANOPIES FOR ZERO SHAPES ON PAGE 94**













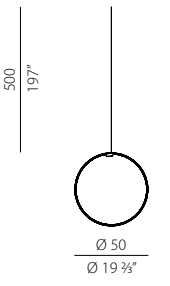



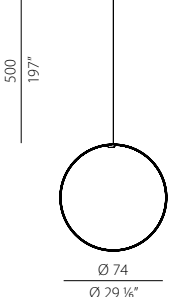



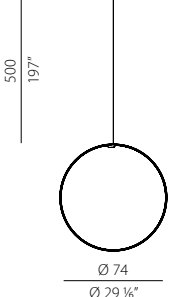



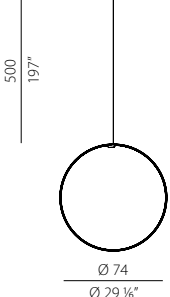

# ZERO SHAPES

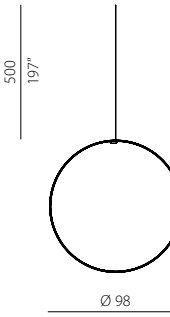
Enzo Panzeri 2018

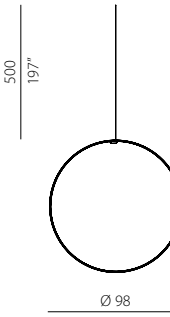

Lampada a sospensione verticale in alluminio estruso curvato con schermo in policarbonato opale. Emissione interna attraverso modulo LED e tecnologia DALI/Push DIM di serie su tutte le versioni inserita nel rosone. Anello rifinito con vernice poliaccrilica color bianco, nero, titanio, bronzo e ottone satinato. Possibili colori custom su richiesta. Disponibilità di rosone per installazioni singole e rosone per composizioni multiple da ordinare separatamente. Ideale per uffici, hall, zone living, grandi spazi, anche in abbinamento con Zero Round Acoustic e Arena Acoustic.

Vertical suspension lamp in extruded curved aluminum with opal polycarbonate screen. Emission of internal light through LED module and DALI/Push DIM technology on all the versions in the canopy. Polyacrylic white, black titanium bronze or mat brass painted. Canopy for single installations and canopies for multiple configurations are available, to be ordered separately. Ideal for offices, halls, living areas, large spaces, also combined with Zero Round Acoustic and Arena Acoustic.

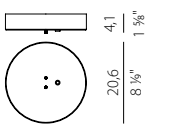
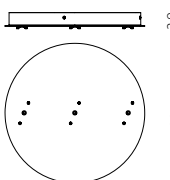
	CODICE CODE	FONTI LUMINOSE LIGHT SOURCES	kg
 <p>500 197"</p> <p>Ø 50 Ø 19 3/8"</p>	 <b>M03401.050.0510</b>	Potenza assorbita apparecchio / Luminaire power consumption 25W	0,81
	<b>M03402.050.0510</b>	Flusso luminoso apparecchio / Luminaire luminous flux 2039lm	
	<b>M03417.050.0510</b>	2700K Ra>90 24V DC  <b>IP20</b> 	
	<b>M03419.050.0510</b>	Fornito senza rosone e driver, per composizioni singole o multiple	
	<b>M03430.050.0510</b>	Supplied without canopy and driver, for multiple configurations	
 <p>500 197"</p> <p>Ø 74 Ø 29 1/8"</p>	 <b>M03401.050.0410</b>	Potenza assorbita apparecchio / Luminaire power consumption 25W	0,81
	<b>M03402.050.0410</b>	Flusso luminoso apparecchio / Luminaire luminous flux 2039lm	
	<b>M03417.050.0410</b>	3000K Ra>90 24V DC  <b>IP20</b> 	
	<b>M03419.050.0410</b>	Fornito senza rosone e driver, per composizioni singole o multiple	
	<b>M03430.050.0410</b>	Supplied without canopy and driver, for multiple configurations	
 <p>500 197"</p> <p>Ø 74 Ø 29 1/8"</p>	 <b>M03401.075.0510</b>	Potenza assorbita apparecchio / Luminaire power consumption 36W	1,09
	<b>M03402.075.0510</b>	Flusso luminoso apparecchio / Luminaire luminous flux 3059lm	
	<b>M03417.075.0510</b>	2700K Ra>90 24V DC  <b>IP20</b> 	
	<b>M03419.075.0510</b>	Fornito senza rosone e driver, per composizioni singole o multiple	
	<b>M03430.075.0510</b>	Supplied without canopy and driver, for multiple configurations	
 <p>500 197"</p> <p>Ø 74 Ø 29 1/8"</p>	 <b>M03401.075.0410</b>	Potenza assorbita apparecchio / Luminaire power consumption 36W	1,09
	<b>M03402.075.0410</b>	Flusso luminoso apparecchio / Luminaire luminous flux 3059lm	
	<b>M03417.075.0410</b>	3000K Ra>90 24V DC  <b>IP20</b> 	
	<b>M03419.075.0410</b>	Fornito senza rosone e driver, per composizioni singole o multiple	
	<b>M03430.075.0410</b>	Supplied without canopy and driver, for multiple configurations	
 <p>500 197"</p> <p>Ø 98 Ø 38 5/8"</p>	 <b>M03401.100.0510</b>	Potenza assorbita apparecchio / Luminaire power consumption 47W	1,39
	<b>M03402.100.0510</b>	Flusso luminoso apparecchio / Luminaire luminous flux 4079lm	
	<b>M03417.100.0510</b>	2700K Ra>90 24V DC  <b>IP20</b> 	
	<b>M03419.100.0510</b>	Fornito senza rosone e driver, per composizioni singole o multiple	
	<b>M03430.100.0510</b>	Supplied without canopy and driver, for multiple configurations	
 <p>500 197"</p> <p>Ø 98 Ø 38 5/8"</p>	 <b>M03401.100.0410</b>	Potenza assorbita apparecchio / Luminaire power consumption 47W	1,39
	<b>M03402.100.0410</b>	Flusso luminoso apparecchio / Luminaire luminous flux 4079lm	
	<b>M03417.100.0410</b>	3000K Ra>90 24V DC  <b>IP20</b> 	
	<b>M03419.100.0410</b>	Fornito senza rosone e driver, per composizioni singole o multiple	
	<b>M03430.100.0410</b>	Supplied without canopy and driver, for multiple configurations	
 <p>41 1 5/8"</p> <p>20,6 8 1/8"</p>	<b>XM03401.531.0002</b>	Rosone per alimentazione e sospensione di 1 modello Zero Round Vertical, con driver 60W/24V DALI/Push DIM.	1,05
	<b>XM03402.531.0002</b>	Canopy for power supply and suspension of 1 Zero Round Vertical model, with 60W/24V DALI/Push DIM drivers.	
	<b>XM03417.531.0002</b>		
	<b>XM03419.531.0002</b>		
	<b>XM03430.531.0002</b>		
 <p>3,8 1 1/2"</p> <p>39,5 15 5/8"</p>	<b>XM03401.533.0002</b>	Rosone per alimentazione e sospensione di 3 modelli Zero Round Vertical, con n.3 driver 60W/24V DALI/Push DIM.	4,26
	<b>XM03402.533.0002</b>	Canopy for power supply and suspension of 3 Zero Round Vertical models, with n.3 60W/24V DALI/Push DIM drivers.	
	<b>XM03417.533.0002</b>		
	<b>XM03419.533.0002</b>		
	<b>XM03430.533.0002</b>		

Fotometrie disponibili [www.panzeri.it](http://www.panzeri.it) / Photometric data available at [www.panzeri.it](http://www.panzeri.it)

## CODICI COLORI DISPONIBILI / COLOUR CODES AVAILABLE

<b>01</b> bianco white	<b>02</b> nero black	<b>17</b> bronzo bronze	<b>19</b> ottone satinato mat brass	<b>30</b> titanio titanium
---------------------------	-------------------------	----------------------------	--	-------------------------------



Lampada a sospensione in alluminio estruso curvato con schermo in policarbonato opale. Emissione interna attraverso modulo LED e tecnologia DALI/Push DIM di serie su tutte le versioni inserita nel rosone. Anello rifinito con vernice poliacrilica color bianco, nero, titanio, bronzo e ottone satinato. Possibili colori custom su richiesta. Disponibilità di rosone per installazioni singole e composizioni multiple in abbinamento a Zero Round e Zero Square da ordinare separatamente. Ideale per uffici, hall, zone living, grandi spazi, anche con Zero Round Acoustic e Arena Acoustic.

Suspension lamp in extruded curved aluminium with opal polycarbonate screen. Emission on the internal side provided by LED modules with technology DALI/ Push DIM integrated into the canopy. Polyacrilic paint white, black, titanium, bronze and mat brass finishes are available. Custom colors are available on request. Canopies for single and multiple configurations with Zero Round and Zero Square are available, to be ordered separately. Ideal for offices, halls, living, and public spaces, also combined with Zero Round Acoustic and Arena Acoustic.

	CODICE CODE	FONTE LUMINOSA LIGHT SOURCES	kg
	<b>M03101.130.0510</b>	Potenza assorbita apparecchio / Luminaire power consumption 47W	1,53
	<b>M03102.130.0510</b>	Flusso luminoso apparecchio / Luminaire luminous flux 4079lm	
	<b>M03117.130.0510</b>	2700K Ra>90 24V DC	
	<b>M03119.130.0510</b>	IP20	
	<b>M03130.130.0510</b>	Fornito senza rosone e driver, per composizioni singole o multiple Supplied without canopy and driver, for multiple configurations	
	<b>M03101.130.0410</b>	Potenza assorbita apparecchio / Luminaire power consumption 47W	1,53
	<b>M03102.130.0410</b>	Flusso luminoso apparecchio / Luminaire luminous flux 4079lm	
	<b>M03117.130.0410</b>	3000K Ra>90 24V DC	
	<b>M03119.130.0410</b>	IP20	
	<b>M03130.130.0410</b>	Fornito senza rosone e driver, per composizioni singole o multiple Supplied without canopy and driver, for multiple configurations	

Fotometrie disponibili [www.panzeri.it](http://www.panzeri.it) / Photometric data available at [www.panzeri.it](http://www.panzeri.it)

**CODICI COLORI DISPONIBILI / COLOUR CODES AVAILABLE**

- 01** bianco  
white
- 02** nero  
black
- 17** bronzo  
bronze
- 19** ottone satinato  
mat brass
- 30** titanio  
titanium





# ZERO SHAPES

Enzo Panzeri 2019



Lampada a sospensione in alluminio estruso curvato con schermo in policarbonato opale. Emissione interna attraverso modulo LED e tecnologia DALI/Push DIM di serie su tutte le versioni inserita nel rosone. Anello rifinito con vernice poliaccrilica color bianco, nero, titanio, bronzo e ottone satinato. Possibili colori custom su richiesta. Disponibilità di rosone per installazioni singole e composizioni multiple in abbinamento a Zero Ellipse e Zero Round da ordinare separatamente. Ideale per uffici, hall, zone living, grandi spazi, anche in abbinamento con Zero Round Acoustic e Arena Acoustic.

Suspension lamp in extruded curved aluminium with opal polycarbonate screen. Emission on the internal side provided by LED modules with technology DALI/ Push DIM integrated into the canopy. Polyacrilic paint white, black, titanium, bronze and mat brass finishes are available. Custom colors are available on request. Canopies for single and multiple configurations with Zero Ellipse and Zero Round are available, to be ordered separately. Ideal for offices, halls, living, and public spaces, also combined with Zero Round Acoustic and Arena Acoustic.

	CODICE CODE	FONTI LUMINOSE LIGHT SOURCES	kg
	<b>M03201.050.0510</b>	Potenza assorbita apparecchio / Luminaire power consumption 25W	0,92
	<b>M03202.050.0510</b>	Flusso luminoso apparecchio / Luminaire luminous flux 2039lm	
	<b>M03217.050.0510</b>	2700K Ra>90 24V DC	
	<b>M03219.050.0510</b>	<b>IP20</b>	
	<b>M03230.050.0510</b>	Fornito senza rosone e driver, per composizioni singole o multiple Supplied without canopy and driver, for multiple configurations	
	<b>M03201.050.0410</b>	Potenza assorbita apparecchio / Luminaire power consumption 25W	0,92
	<b>M03202.050.0410</b>	Flusso luminoso apparecchio / Luminaire luminous flux 2039lm	
	<b>M03217.050.0410</b>	3000K Ra>90 24V DC	
	<b>M03219.050.0410</b>	<b>IP20</b>	
	<b>M03230.050.0410</b>	Fornito senza rosone e driver, per composizioni singole o multiple Supplied without canopy and driver, for multiple configurations	
	<b>M03201.075.0510</b>	Potenza assorbita apparecchio / Luminaire power consumption 36W	1,21
	<b>M03202.075.0510</b>	Flusso luminoso apparecchio / Luminaire luminous flux 3059lm	
	<b>M03217.075.0510</b>	2700K Ra>90 24V DC	
	<b>M03219.075.0510</b>	<b>IP20</b>	
	<b>M03230.075.0510</b>	Fornito senza rosone e driver, per composizioni singole o multiple Supplied without canopy and driver, for multiple configurations	
	<b>M03201.075.0410</b>	Potenza assorbita apparecchio / Luminaire power consumption 36W	1,21
	<b>M03202.075.0410</b>	Flusso luminoso apparecchio / Luminaire luminous flux 3059lm	
	<b>M03217.075.0410</b>	3000K Ra>90 24V DC	
	<b>M03219.075.0410</b>	<b>IP20</b>	
	<b>M03230.075.0410</b>	Fornito senza rosone e driver, per composizioni singole o multiple Supplied without canopy and driver, for multiple configurations	

Fotometrie disponibili [www.panzeri.it](http://www.panzeri.it) / Photometric data available at [www.panzeri.it](http://www.panzeri.it)

### CODICI COLORI DISPONIBILI / COLOUR CODES AVAILABLE

- 01** bianco white
- 02** nero black
- 17** bronzo bronze
- 19** ottone satinato mat brass
- 30** titanio titanium



ROSONI PER ZERO SHAPES A PAGINA 94 / CANOPIES FOR ZERO SHAPES ON PAGE 94

## **OFFSET AND CANOPIES**

- 99 CANOPIES FOR MULTIPLE FIXING
- 96 OFFSET CANOPIES
- 97 OFFSET CANOPIES ACCESSORIES
- 98 RECESSED CANOPIES
- 94 ZERO SHAPES CANOPIES

# ROSONI ZERO SHAPES / ZERO SHAPES CANOPIES

Officina Panzeri 2024



Un'ampia selezione di rosoni con alimentatore integrato predisposta per la sospensione degli apparecchi della famiglia Zero Shapes. Disponibili in varie misure e finiture, permettono di sostenere e alimentare singoli elementi, oppure creative composizioni multiple. Altre versioni disponibili a richiesta.







A wide selection of canopies with integrated power supply arranged for the suspension of the Zero Shapes family's fixtures. Available in various sizes and finishes, they allow the hanging and feeding of single elements or creative multiple compositions. Other versions available on request.

			CODICE CODE	DESCRIZIONE DESCRIPTION	kg
			<b>XM03301.511.0002</b> <b>XM03302.511.0002</b> <b>XM03317.511.0002</b> <b>XM03319.511.0002</b> <b>XM03330.511.0002</b>	Rosone per alimentazione e sospensione di 1 modello Zero Shapes Horizontal, con driver. Driver 60W / 24V DALI/Push DIM Canopy for power supply and suspension of 1 Zero Shapes Horizontal model, with driver. Driver 60W / 24V DALI/Push DIM	0,7
			<b>XM03301.531.0002</b> <b>XM03302.531.0002</b> <b>XM03317.531.0002</b> <b>XM03319.531.0002</b> <b>XM03330.531.0002</b>	Rosone per alimentazione e sospensione di 1 modello Zero Shapes Horizontal, con driver. Driver 60W / 24V DALI/Push DIM Canopy for power supply and suspension of 1 Zero Shapes Horizontal model, with driver. Driver 60W / 24V DALI/Push DIM	0,7
			<b>XM03301.522.0002</b> <b>XM03302.522.0002</b> <b>XM03317.522.0002</b> <b>XM03319.522.0002</b> <b>XM03330.522.0002</b>	Rosone per alimentazione di 2 modelli Zero Shapes, con n.2 driver. 2 x driver 60W / 24V DALI/Push DIM Canopy for power supply of 2 Zero Shapes models, with n.2 drivers. 2 x driver 60W / 24V DALI/Push DIM	2,93
			<b>XM03301.532.0002</b> <b>XM03302.532.0002</b> <b>XM03317.532.0002</b> <b>XM03319.532.0002</b> <b>XM03330.532.0002</b>	Rosone per alimentazione e sospensione di 2 modelli Zero Shapes Horizontal, con n.2 driver. 2 x driver 60W / 24V DALI/Push DIM Canopy for power supply and suspension of 2 Zero Shapes Horizontal models, with n.2 drivers. 2 x driver 60W / 24V DALI/Push DIM	3,04

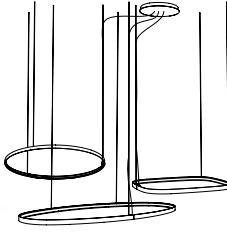
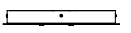
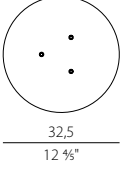
## CODICI COLORI DISPONIBILI / COLOUR CODES AVAILABLE

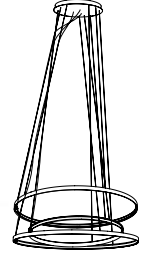
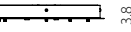
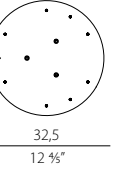
**01** bianco / white      **02** nero / black      **17** bronzo / bronze      **19** ottone satinato / matt brass      **30** titanio / titanium

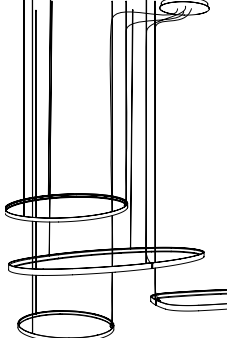
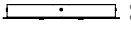
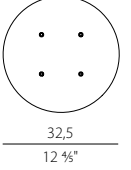

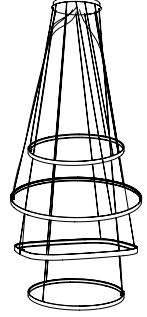
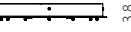
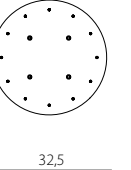
		CODICE CODE	DESCRIZIONE DESCRIPTION	kg	
		 	<b>XM03301.523.0002</b>	Rosone per alimentazione di 3 modelli Zero Shapes, con n.3 driver. 3x driver 60W / 24V DALI/Push DIM Canopy for power supply of 3 Zero Shapes models, with n.3 drivers. 3x driver 60W / 24V DALI/Push DIM	3,02
			<b>XM03302.523.0002</b>		
			<b>XM03317.523.0002</b>		
			<b>XM03319.523.0002</b>		
			<b>XM03330.523.0002</b>		
		 	<b>XM03301.533.0002</b>	Rosone per alimentazione e sospensione di 3 modelli Zero Shapes Horizontal, con n.3 driver. 3x driver 60W / 24V DALI/Push DIM Canopy for power supply and suspension of 3 Zero Shapes Horizontal models, with n.3 drivers. 3x driver 60W / 24V DALI/Push DIM	3,29
			<b>XM03302.533.0002</b>		
			<b>XM03317.533.0002</b>		
			<b>XM03319.533.0002</b>		
			<b>XM03330.533.0002</b>		
		 	<b>XM03301.524.0002</b>	Rosone per alimentazione di 4 modelli Zero Shapes, con n.4 driver. 4x driver 60W / 24V DALI/Push DIM Canopy for power supply of 4 Zero Shapes models, with n.4 drivers. 4x driver 60W / 24V DALI/Push DIM	3,11
			<b>XM03302.524.0002</b>		
			<b>XM03317.524.0002</b>		
			<b>XM03319.524.0002</b>		
			<b>XM03330.524.0002</b>		
		 	<b>XM03301.534.0002</b>	Rosone per alimentazione e sospensione di 4 modelli Zero Shapes Horizontal, con n.4 driver. 4x driver 60W / 24V DALI/Push DIM Canopy for power supply and suspension of 4 Zero Shapes Horizontal models, with n.4 drivers. 4x driver 60W / 24V DALI/Push DIM	3,56
			<b>XM03302.534.0002</b>		
			<b>XM03317.534.0002</b>		
			<b>XM03319.534.0002</b>		
			<b>XM03330.534.0002</b>		

Altre versioni disponibili a richiesta / Other versions available on request.

CODICI COLORI DISPONIBILI / COLOUR CODES AVAILABLE

- |                           |                         |                            |   |                               |
|---------------------------|-------------------------|----------------------------|---|-------------------------------|
| <b>01</b> bianco<br>white | <b>02</b> nero<br>black | <b>17</b> bronzo<br>bronze | <b>19</b> ottone satinato<br>matt brass | <b>30</b> titanio<br>titanium |
|---------------------------|-------------------------|----------------------------|---|-------------------------------|



Rosoni tondi di dimensioni ridotte, senza viti a vista, predisposti per accogliere 1, 2 o 3 apparecchi a sospensione alimentati a tensione di rete. Disponibili a corredo decentramenti per cavi di sospensione e di alimentazione che permettono di sospendere gli apparecchi in posizioni decentrate rispetto al punto luce.

Small round canopies, without visible screws, designed to accommodate 1, 2 or 3 mains-voltage suspension fixtures. Offsets for suspension and power supply cables are available to hang the luminaires off-centre from the lighting point.

NEW

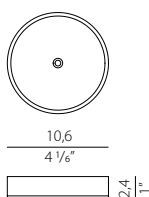

CODICE CODE	DESCRIZIONE DESCRIPTION	kg
<b>RT01001.0001.000</b>	Rosone per collegamento elettrico di n.1	0,03
<b>RT01002.0001.000</b>	apparecchio. Utilizzabile con apparecchi 24V prevedendo driver remoto.	
<b>RT01017.0001.000</b>	Canopy for electrical connection of no.1	
<b>RT01019.0001.000</b>	fixture. Suitable for 24V fixtures: remote driver 24V needed.	

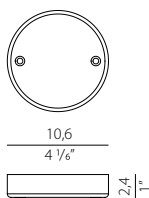

<b>RT01001.0002.000</b>	Rosone per collegamento elettrico di n.2	0,03
<b>RT01002.0002.000</b>	apparecchi. Utilizzabile con apparecchi 24V prevedendo driver remoto.	
<b>RT01017.0002.000</b>	Canopy for electrical connection of no.2	
<b>RT01019.0002.000</b>	fixtures. Suitable for 24V fixtures: remote driver 24V needed.	

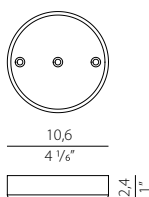

<b>RT01001.0003.000</b>	Rosone per collegamento elettrico di n.3	0,03
<b>RT01002.0003.000</b>	apparecchi. Utilizzabile con apparecchi 24V prevedendo driver remoto.	
<b>RT01017.0003.000</b>	Suitable for 24V fixtures: remote driver	
<b>RT01019.0003.000</b>	24V needed. Canopy for electrical connection of no.3 fixtures.	

## CODICI COLORI DISPONIBILI / COLOUR CODES AVAILABLE





**01** bianco white      **02** nero black      **17** bronzo bronze      **19** ottone satinato matt brass

# ACCESSORI PER DECENTRAMENTI / OFFSET CANOPIES ACCESSORIES

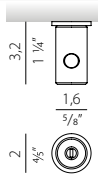

Elementi per il fissaggio di funi di sospensione e cavi di alimentazione per creare composizioni di apparecchi personalizzate..

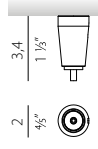
Elements for fixing suspension ropes and power cables to create customized luminaires configurations.

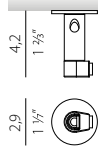
		CODICE CODE	DESCRIZIONE DESCRIPTION	kg
		<b>M800</b>	Appendimento in policarbonato per sospensione Polycarbonate hook for suspension	0,01
		<b>M79D</b>	Dispositivo di sospensione e regolazione per fune in acciaio. Suspension and adjustment device for steel cable.	0,03
		<b>M75D</b>	Dispositivo di sospensione e regolazione per cavo elettrico. Suspension and adjustment device for electric cable.	0,03

CODICI COLORI DISPONIBILI / COLOUR CODES AVAILABLE

01 bianco  
white



Rosoni piccoli e minimali installabili ad incasso nei controsoffitti, predisposti per accogliere il cavo di alimentazione di apparecchi a sospensione.

Small, minimalist ceiling canopies for recessed installation in false ceilings, designed to carry the feeding cable of suspension fixtures.

Apparecchi compatibili 220-240V / Supported fixtures 220-240V



Apparecchi compatibili 24V / Supported fixtures 24V



CODICE CODE	DESCRIZIONE DESCRIPTION	kg
-------------	-------------------------	----



**RI00801.0001.000**

Rosone a scomparsa per sospensioni con solo cavo elettrico, utilizzabile per tutti gli apparecchi a 24V prevedendo driver remoto. 0,13

Recessed canopy for electric cable suspensions. Suitable for 24V fixtures: remote driver 24V needed.

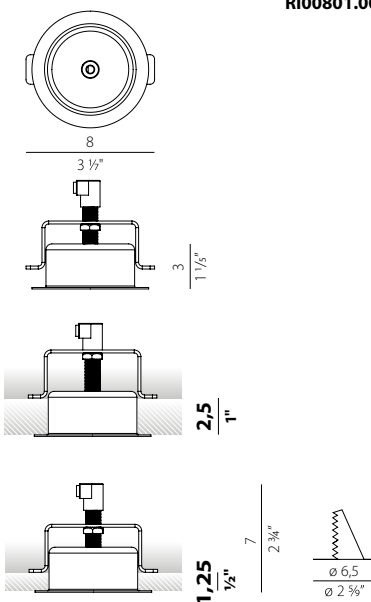

**NEW**

**RF00501.0001.000**

Rosone a filo per sospensioni con solo cavo elettrico, utilizzabile per tutti gli apparecchi a 24V prevedendo driver remoto. 0,10

Flush canopy for electric cable suspensions. Suitable for 24V fixtures: remote driver 24V needed.

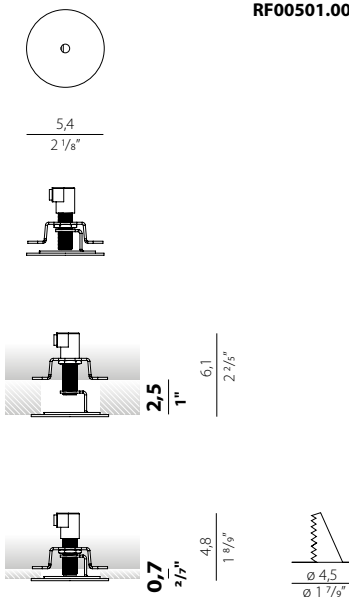

# ROSONI PER FISSAGGI MULTIPLI / CANOPIES FOR MULTIPLE FIXING



Un'ampia selezione di rosoni con alimentatore integrato predisposta per la sospensione degli apparecchi della famiglia Zero Shapes. Disponibili in varie misure e finiture, permettono di sostenere e alimentare singoli elementi, oppure creative composizioni multiple.

A wide selection of canopies with integrated power supply arranged for the suspension of the Zero Shapes family's fixtures. Available in various sizes and finishes, they allow the hanging and feeding of single elements or creative multiple compositions.

Apparecchi compatibili 220-240V / Supported fixtures 220-240V



Apparecchi compatibili 24V / Supported fixtures 24V



NEW

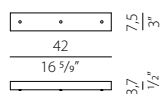

CODICE CODE	DESCRIZIONE DESCRIPTION	kg
<b>RL04201.0003.000</b>	Rosone lineare per collegamento elettrico con 3 uscite.	0,95
<b>RL04202.0003.000</b>	Linear canopy for power supply with 3 outputs.	
<b>RL04217.0003.000</b>		
<b>RL04219.0003.000</b>		
<b>RL04201.0003.A01</b>	Rosone lineare per alimentazione e sospensione di massimo 3 modelli a tensione costante 24V DC.	1,17
<b>RL04202.0003.A01</b>	Driver 30W/24V on/off.	
<b>RL04217.0003.A01</b>		
<b>RL04219.0003.A01</b>	Linear canopy for supply and suspension up to 3 24V DC constant voltage models maximum. Driver 30W/24V on/off.	

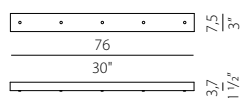

<b>RL07601.0005.000</b>	Rosone lineare per collegamento elettrico con 5 uscite.	1,58
<b>RL07602.0005.000</b>	Linear canopy for power supply with 5 outputs.	
<b>RL07617.0005.000</b>		
<b>RL07619.0005.000</b>		
<b>RL07601.0005.A01</b>	Rosone lineare per alimentazione e sospensione di massimo 5 modelli a tensione costante 24V DC.	1,78
<b>RL07602.0005.A01</b>	Driver 30W/24V on/off.	
<b>RL07617.0005.A01</b>		
<b>RL07619.0005.A01</b>	Linear canopy for supply and suspension up to 5 24V DC constant voltage models maximum. Driver 30W/24V on/off.	

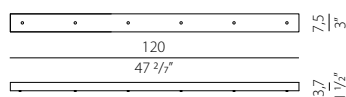

<b>RL12001.0006.000</b>	Rosone lineare per collegamento elettrico con 6 uscite.	2,37
<b>RL12002.0006.000</b>	Linear canopy for power supply with 6 outputs.	
<b>RL12017.0006.000</b>		
<b>RL12019.0006.000</b>		
<b>RL12001.0006.B01</b>	Rosone lineare per alimentazione e sospensione di massimo 6 modelli a tensione costante 24V DC.	2,71
<b>RL12002.0006.B01</b>	Driver 75W/24V on/off.	
<b>RL12017.0006.B01</b>		
<b>RL12019.0006.B01</b>	Linear canopy for supply and suspension up to 6 24V DC constant voltage models maximum. Driver 75W/24V on/off.	

CODICI COLORI DISPONIBILI / COLOUR CODES AVAILABLE

**01** bianco white      **02** nero black      **17** bronzo bronze      **19** ottone satinato matt brass

**NEW**

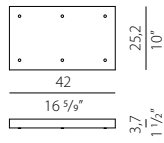

CODICE CODE	DESCRIZIONE DESCRIPTION	kg
<b>RR04201.0006.000</b>	Rosone rettangolare per collegamento elettrico con 6 uscite.	1,78
<b>RR04202.0006.000</b>	Rectangular canopy for power supply with 6 outputs.	
<b>RR04217.0006.000</b>		
<b>RR04219.0006.000</b>		
<b>RR04201.0006.B01</b>	Rosone rettangolare per alimentazione e sospensione di massimo 6 modelli a tensione costante 24V DC. Driver 75W/24V on/off.	2,13
<b>RR04202.0006.B01</b>		
<b>RR04217.0006.B01</b>		
<b>RR04219.0006.B01</b>	Rectangular canopy for power supply and suspension up to 6 24V DC constant voltage models maximum. Driver 75W/24V on/off.	

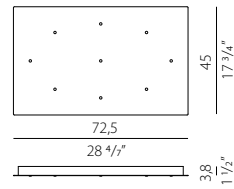



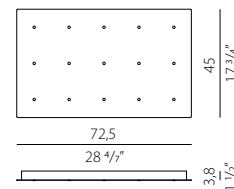

<b>RR07201.0009.000</b>	Rosone rettangolare per collegamento elettrico con 9 uscite.	6,01
	Rectangular canopy for power supply with 9 outputs.	

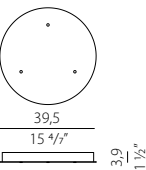

<b>RR07201.0015.000</b>	Rosone rettangolare per collegamento elettrico con 15 uscite.	5,75
	Rectangular canopy for power supply with 15 outputs.	

**CODICI COLORI DISPONIBILI / COLOUR CODES AVAILABLE**

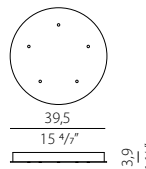
- |                           |                         |                            |   |
|---------------------------|-------------------------|----------------------------|---|
| <b>01</b> bianco<br>white | <b>02</b> nero<br>black | <b>17</b> bronzo<br>bronze | <b>19</b> ottone satinato<br>matt brass |
|---------------------------|-------------------------|----------------------------|---|

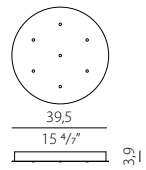
NEW		CODICE CODE	DESCRIZIONE DESCRIPTION	kg
		<b>RT03901.0003.000</b>	Rosone tondo per collegamento elettrico con 3 uscite.	3,00
		<b>RT03902.0003.000</b>	Round canopy for power supply with 3 outputs.	
		<b>RT03917.0003.000</b>		
		<b>RT03919.0003.000</b>		
		<b>RT03901.0005.000</b>	Rosone tondo per collegamento elettrico con 5 uscite.	3,00
		<b>RT03902.0005.000</b>	Round canopy for power supply with 5 outputs.	
		<b>RT03917.0005.000</b>		
		<b>RT03919.0005.000</b>		
		<b>RT03901.0007.000</b>	Rosone tondo per collegamento elettrico con 7 uscite.	3,00
		<b>RT03902.0007.000</b>	Round canopy for power supply with 7 outputs.	
		<b>RT03917.0007.000</b>		
		<b>RT03919.0007.000</b>		
		<b>RT03901.0007.B01</b>	Rosone per alimentazione e sospensione di massimo 7 modelli a tensione costante 24V DC. Driver 75W/24V on/off.	3,25
		<b>RT03902.0007.B01</b>		
		<b>RT03917.0007.B01</b>		
		<b>RT03919.0007.B01</b>	Canopy for supply and suspension up to 7 24V DC constant voltage models maximum. Driver 75W/24V on/off.	

CODICI COLORI DISPONIBILI / COLOUR CODES AVAILABLE

**01** bianco white      **02** nero black      **17** bronzo bronze      **19** ottone satinato matt brass

**NEW**

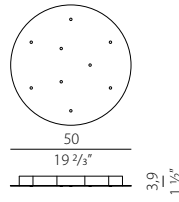

CODICE CODE	DESCRIZIONE DESCRIPTION	kg
<b>RT05001.0009.000</b>	Rosone tondo per collegamento elettrico con 9 uscite.	5,17
<b>RT05002.0009.000</b>		
<b>RT05017.0009.000</b>	Round canopy for power supply with 9 outputs.	
<b>RT05019.0009.000</b>		
<b>RT05001.0009.B01</b>	Rosone tondo per alimentazione e sospensione di massimo 9 modelli a tensione costante 24V DC. Driver 75W/24V on/off.	5,49
<b>RT05002.0009.B01</b>		
<b>RT05017.0009.B01</b>		
<b>RT05019.0009.B01</b>	Round canopy for supply and suspension up to 9 24V DC constant voltage models maximum. Driver 75W/24V on/off.	

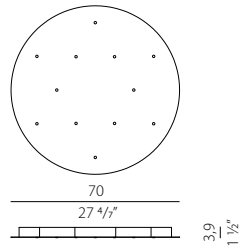

<b>RT07001.0012.000</b>	Rosone tondo per collegamento elettrico con 12 uscite. Round canopy for power supply with 12 outputs.	7,11
-------------------------	--	------

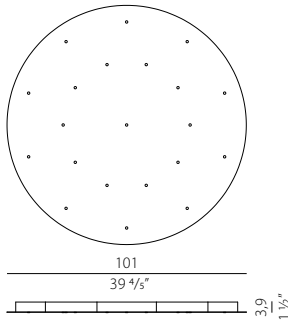

<b>RT10101.0021.000</b>	Rosone tondo per collegamento elettrico con 21 uscite. Round canopy for power supply with 21 outputs.	14,6
-------------------------	--	------

**CODICI COLORI DISPONIBILI / COLOUR CODES AVAILABLE**

- |                           |                         |                            |   |
|---------------------------|-------------------------|----------------------------|---|
| <b>01</b> bianco<br>white | <b>02</b> nero<br>black | <b>17</b> bronzo<br>bronze | <b>19</b> ottone satinato<br>matt brass |
|---------------------------|-------------------------|----------------------------|---|



## ACUSTICA / ACOUSTIC

- 104 ARENA ACOUSTIC
- 105 PHI
- 106 ZERO ROUND ACOUSTIC



# ARENA ACOUSTIC

Enzo Panzeri 2021



Sospensione fonoassorbente per illuminazione diretta, con driver integrato per regolazione dell'intensità luminosa tramite dispositivi DALI o Push DIM. Pannello fonoassorbente in PET con assorbimento acustico di Classe C che riduce fino al 70% del suono riverberato (NRC 0.7) e con classe di reazione al fuoco Classe 1 ISO 9705. La superficie fonoassorbente è inserita nello stesso profilo in alluminio di Arena, prestandosi ad originali composizioni di elementi acustici e lampade a sospensione delle famiglie Zero Shapes e Arena. Bianco, nero, bronzo, ottone satinato e titanio le finiture disponibili. Pannello in PET colore basalto, colori custom a richiesta.

Sound-absorbing suspension with downwards illumination, with integrated power supply for dimming the light intensity through DALI or Push DIM protocol. Acoustic PET panel with sound absorption Class C which reduces up to 70% of reverberated sound (NRC 0.7) and a Group 1 ISO 9705 fire rating. The sound-absorbing panel is inside the same aluminum profile as Arena, useful for compositions of acoustic elements and suspension lamps (Zero Shapes and Arena). White, black, titanium, bronze and mat brass finishes are available. Acoustic PET panel in basalt color, custom colors are available on request.

CODICE CODE	FONTI LUMINOSE LIGHT SOURCES	kg
-------------	------------------------------	----

<b>L04601.100.0502</b>	Potenza assorbita apparecchio / Luminaire power consumption 51W	5,80
<b>L04602.100.0502</b>	Flusso luminoso apparecchio / Luminaire luminous flux 1434lm	
<b>L04617.100.0502</b>	2700K Ra>90 220-240V AC dimmable (DALI/Push DIM)	
<b>L04619.100.0502</b>	IP20	
<b>L04630.100.0502</b>		

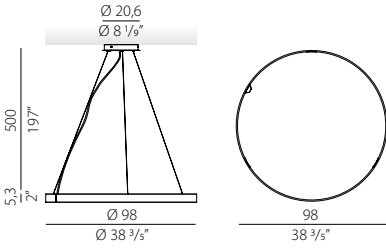

Fotometrie disponibili [www.panzeri.it](http://www.panzeri.it) / Photometric data available at [www.panzeri.it](http://www.panzeri.it)

UGR<19 in funzione delle condizioni di installazione / UGR<19 depending on installation conditions

## CODICI COLORI DISPONIBILI / COLOUR CODES AVAILABLE



**slalom**<sup>®</sup>  
acoustic & partition systems

<b>L05601.100.0502</b>	Potenza assorbita apparecchio / Luminaire power consumption 51W	5,80
<b>L05602.100.0502</b>	Flusso luminoso apparecchio / Luminaire luminous flux 1434lm	
<b>L05617.100.0502</b>	2700K Ra>90 220-240V AC dimmable (DALI/Push DIM)	
<b>L05619.100.0502</b>	IP20	
<b>L05630.100.0502</b>		

## Panel by Slalom

<b>L05601.100.0502</b>	Potenza assorbita apparecchio / Luminaire power consumption 51W	5,80
<b>L05602.100.0502</b>	Flusso luminoso apparecchio / Luminaire luminous flux 1434lm	
<b>L05617.100.0502</b>	2700K Ra>90 220-240V AC dimmable (DALI/Push DIM)	
<b>L05619.100.0502</b>	IP20	
<b>L05630.100.0502</b>		

Pannello fonoassorbente by Slalom  
Struttura bianca 01, pannello "natural grey"  
Struttura nera 02, pannello "morning green"  
Struttura bronzo 17, pannello "brick"  
Struttura ottone satinato 19, pannello "milk"  
Struttura titanio 30, pannello "mud"

Sound-absorbing panel by Slalom  
White 01 structure, "natural grey" panel  
Black 02 structure, "morning green" panel  
Bronze 17 structure, "brick" panel  
Mat brass 19 structure, "milk" panel  
Titanium 30 structure, "mud" panel

Il pannello fonoassorbente "MILLERIGHE" con rivestimento "PETfelt", realizzato con il materiale ricavato dal riciclo di bottiglie di plastica, o "PETfabric", in poliestere riciclato, offre un elevato comfort acustico, resistenza al fuoco ed idoneo per le certificazioni architettoniche di edifici Breeam, Leed, Well e Fitwel.

Sound-absorbing panel "MILLERIGHE" with "PETfelt" finish, made with the material obtained from the recycling of plastic bottles, or "PETfabric", recycled polyester, offers high acoustic comfort, fire resistance and is suitable for Breeam, Leed, Well and Fitwel building certifications.



## YPA05602.030

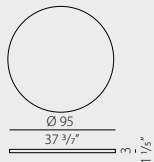

Pannello fonoassorbente per aumento prestazione acustica [coefficiente Alpha W (aw) 0,9]. Altezza finale apparecchio 6,5cm (2 5/9")

Sound absorbing panel for increased acoustic performance [Alpha W coefficient (aw) 0.9]. Fixture total height 6,5cm (2 5/9")

Fotometrie disponibili [www.panzeri.it](http://www.panzeri.it) / Photometric data available at [www.panzeri.it](http://www.panzeri.it)

UGR<19 in funzione delle condizioni di installazione / UGR<19 depending on installation conditions

## CODICI COLORI DISPONIBILI / COLOUR CODES AVAILABLE





Finitura / Finishes **YPA05602.038**

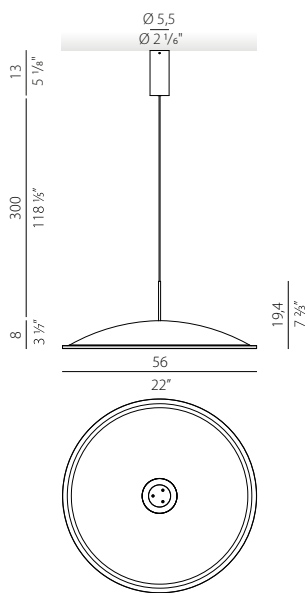

Sospensione fonoassorbente per illuminazione diretta, con driver integrato. Il paralume fonoassorbente by Slalom è composto al 75% da materiale plastico riciclato, rivestito da un sottile strato di feltro sempre riciclato al 96% e accoglie una piccolo elemento luminoso circolare in alluminio pressofuso con sorgente luminosa LED. Disponibile in finiture bianco, nero e ottone satinato con paralume "milk" e in finiture bronzo e titanio con paralume "mud". Adatto a garantire il giusto comfort visivo e acustico negli spazi in cui viene collocata, principalmente ristoranti, aree comuni e spazi commerciali.

Sound-absorbing suspension lamp for direct lighting, with integrated driver. The sound-absorbing lampshade by Slalom is composed of 75% recycled plastic material, covered with a thin layer of felt, also 96% recycled, and houses a small circular die-casted aluminium light element with LED light source. Available in white, black and mat brass finishes with 'milk' lampshade and in bronze and titanium finishes with 'mud' lampshade. Suitable for ensuring the right visual and acoustic comfort in the spaces where it is placed, mainly restaurants, public areas and commercial spaces.



-  **L05801.060.0501**
-  **L05802.060.0501**
-  **L05817.060.0501**
-  **L05819.060.0501**
-  **L05830.060.0501**

CODICE CODE	FONTI LUMINOSE LIGHT SOURCES	kg
-------------	------------------------------	----

Potenza assorbita apparecchio / Luminaire power consumption 8,5W  
 Flusso luminoso apparecchio / Luminaire luminous flux 422lm  
 2700K Ra>90 220-240V AC ON-OFF

 **IP40**  
 Struttura bianca 01, nera 02, ottone satinato 19: paralume fonoassorbente "milk".  
 Struttura bronzo 17, titanio 30: paralume fonoassorbente "mud"  
 White 01, black 02, mat brass 19 structure: sound-absorbing lampshade "milk"  
 Bronze 17, titanium 30 structure: sound-absorbing lampshade "mud"

**slalom**<sup>®</sup>  
 acoustic & partition systems

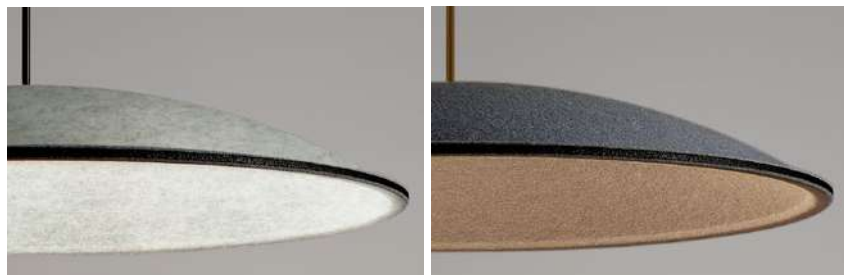

Fotometrie disponibili [www.panzeri.it](http://www.panzeri.it) / Photometric data available at [www.panzeri.it](http://www.panzeri.it)

**CODICI COLORI DISPONIBILI / COLOUR CODES AVAILABLE**

- 01** bianco white
- 02** nero black
- 19** ottone satinato mat brass
- 17** bronzo bronze
- 30** titanio titanium





# ZERO ROUND ACOUSTIC

Enzo Panzeri 2020



Pannello fonoassorbente a sospensione in PET con assorbimento acustico di Classe C che riduce fino al 70% del suono riverberato (NRC 0.7) e con classe di reazione al fuoco Classe 1 ISO 9705. La superficie fonoassorbente è inserita nello stesso profilo in alluminio di Zero Round, prestandosi ad originali composizioni di elementi privi di sorgente luminosa (Zero Round Acoustic) e lampade a sospensione (Zero Round e Arena). Bianco, nero, titanio, bronzo e ottone satinato le finiture disponibili. Pannello in PET colore basalto, colori custom a richiesta.

Acoustic PET panel with sound absorption Class C which reduces up to 70% of reverberated sound (NRC0.7) and a Group 1 ISO 9705 fire rating. The sound-absorbing panel is inside the same aluminium profile as Zero Round, useful for compositions of elements without light source (Zero Round Acoustic) and suspension lamps (Zero Round and Arena). White, black, titanium, bronze and mat brass finishes are available. Acoustic PET panel in basalt color, custom colors are available on request.

CODICE CODE	kg
<b>L04501.100.0099</b>	3,33
<b>L04502.100.0099</b>	
<b>L04517.100.0099</b>	
<b>L04519.100.0099</b>	
<b>L04530.100.0099</b>	

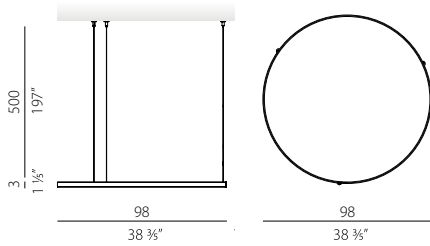

## CODICI COLORI DISPONIBILI / COLOUR CODES AVAILABLE

- 01** bianco / white
- 02** nero / black
- 17** bronzo / bronze
- 19** ottone satinato / mat brass
- 30** titanio / titanium

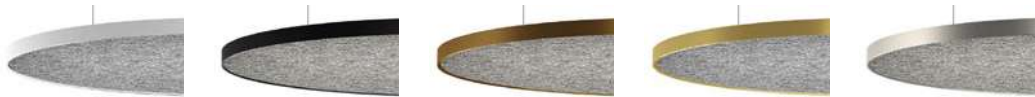

**slalom**  
acoustic & partition systems

- L05501.100.0099**
- L05502.100.0099**
- L05517.100.0099**
- L05519.100.0099**
- L05530.100.0099**

## Panel by Slalom

kg  
3,33

Pannello fonoassorbente by Slalom  
Struttura bianca 01, pannello "natural grey"  
Struttura nera 02, pannello "morning green"  
Struttura bronzo 17, pannello "brick"  
Struttura ottone satinato 19, pannello "milk"  
Struttura titanio 30, pannello "mud"

Sound-absorbing panel by Slalom  
White 01 structure, "natural grey" panel  
Black 02 structure, "morning green" panel  
Bronze 17 structure, "brick" panel  
Mat brass 19 structure, "milk" panel  
Titanium 30 structure, "mud" panel



RECYCLED PLASTIC



ECO FRIENDLY



100% RECYCLABLE



LOW EMISSIONS



100% TRACEABLE SOURCES



MADE IN ITALY

Il pannello fonoassorbente "MILLERIGHE" con rivestimento "PETfelt", realizzato con il materiale ricavato dal riciclo di bottiglie di plastica, o "PETfabric", in poliestere riciclato, offre un elevato comfort acustico, resistenza al fuoco ed idoneo per le certificazioni architettoniche di edifici Breeam, Leed, Well e Fitwel.

Sound-absorbing panel "MILLERIGHE" with "PETfelt" finish, made with the material obtained from the recycling of plastic bottles, or "PETfabric", recycled polyester, offers high acoustic comfort, fire resistance and is suitable for Breeam, Leed, Well and Fitwel building certifications.

## CODICI COLORI DISPONIBILI / COLOUR CODES AVAILABLE

- 01** bianco / natural grey / white / natural grey
- 02** nero / morning green / white / morning green
- 17** bronzo / brick / bronze / brick
- 19** ottone satinato / milk / mat brass / milk
- 30** titanio / mud / titan / mud

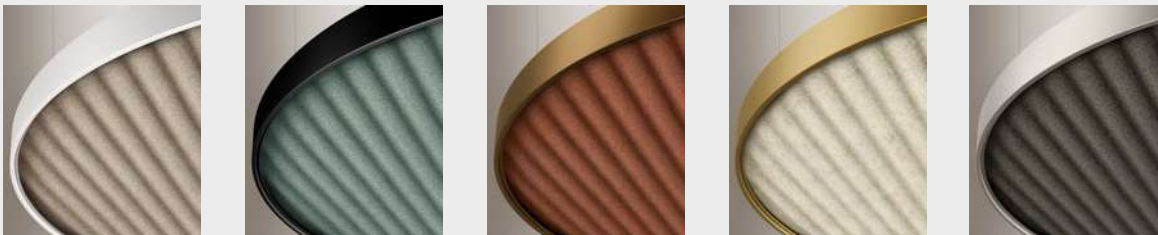

## ESTERNO / OUTDOOR

- 108 DIP
- 109 FIREFLY in the sky
- 111 RALPH
- 113 ROMA
- 114 VENEXIA



# DIP

Hangar Design Group

Registered Design



Con le sue versioni sospensione, parete, soffitto e terra indoor/outdoor, Dip porta la luce dove è necessario, valorizzando con classe ed eleganza ambienti residenziali e commerciali. Il design minimale degli apparecchi viene enfatizzato da un'accurata selezione di finiture specifiche per ogni tipologia di installazione che nella versione terra indoor, lavorano in abbinamento alla base in marmo nero marquina o travertino. Versione da sospensione con cavo di alimentazione regolabile in altezza; versioni da terra, parete e soffitto caratterizzate da un braccio curvo che sostiene la testa orientabile, permettendo di scegliere la direzione del fascio luminoso.

With its suspension, wall, ceiling and floor indoor/outdoor versions, Dip brings light to where it is needed, enhancing residential and commercial environments with class and elegance. The minimalist design of the fixtures is emphasized by a careful selection of specific finishes for each type of installation which in the indoor ground version, work in combination with the black marquina marble or travertine. Suspension version with height-adjustable power supply cable; floor, wall and ceiling versions characterized by a curved arm that supports the adjustable head, allowing the direction of the light beam to be chosen.

NEW

CODICE CODE	FONTI LUMINOSE LIGHT SOURCES	kg
-------------	------------------------------	----

-  **ET08416.170.0527**
- ET08427.170.0527**
- ET08428.170.0527**
- ET08434.170.0527**

Potenza assorbita apparecchio / Luminaire power consumption 18W  
 Flusso luminoso apparecchio / Luminaire luminous flux 1931lm  
 2700K Ra>90 220-240V AC dimmable (Push DIM)

20,00

 IP65 

Fornito completo di interruttore push, cavo 3m e spina  
 Supplied complete with push switch, 3m cable and plug

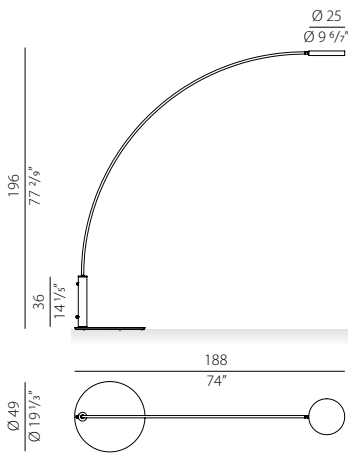

Fotometrie disponibili [www.panzeri.it](http://www.panzeri.it) / Photometric data available at [www.panzeri.it](http://www.panzeri.it)

### CODICI COLORI DISPONIBILI / COLOUR CODES AVAILABLE

- 16** corten  
corten
- 27** verde oliva materico  
textured olive green
- 28** bianco soft materico  
textured soft white
- 34** grigio micaceo  
micaceous grey





# FIREFLY IN THE SKY

Matteo Thun 2019

Registered Design



Firefly in the sky è un apparecchio a batteria da tavolo. La testa removibile racchiude sistema di aggancio magnetico, batteria ricaricabile tramite USB-C, sorgente LED e comando Step DIM a 5 regolazioni di intensità luminosa. In funzione delle condizioni di utilizzo per una ricarica di circa 4 ore si stima un'autonomia di circa 6 ore con intensità della luce al 100% e di circa 24 ore con intensità della luce al 25%. Base antiscivolo già in dotazione. Verde oliva materico, bianco soft materico, terracotta naturale materico e corten si aggiungono alle finiture disponibili nero satinato, bronzo e champagne.

Firefly in the sky is a battery table lamp. The removable head contains magnetic coupling system, rechargeable battery via USB-C, LED source and Step DIM control with 5 light intensity settings. Depending on the conditions of use for a recharge of approximately 4 hours, an autonomy of approximately 6 hours is estimated with 100% light intensity and approximately 24 hours with 25% light intensity. Anti-slip base included. Textured olive green, textured soft white, textured natural terracotta and corten are added to mat black, bronze and champagne finishes available.

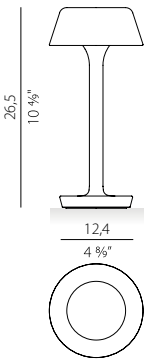

CODICE CODE	FONTI LUMINOSE LIGHT SOURCES	kg
-------------	------------------------------	----



- C07805.011.0514**
- C07806.011.0514**
- C07816.011.0514**
- C07817.011.0514**
- C07827.011.0514**
- C07828.011.0514**
- C07829.011.0514**

Potenza assorbita apparecchio / Luminaire power consumption 2W  
 Flusso luminoso apparecchio / Luminaire luminous flux 134lm  
 2700K Ra>90 5V DC battery Dimmable (Step DIM)

**IP65**

Interruttore incluso / Switch included

In funzione delle condizioni di utilizzo per una ricarica di circa 4 ore si stima un'autonomia di circa 6 ore con intensità della luce al 100% e di circa 24 ore con intensità della luce al 25%. Indicatore LED per lo stato di carica. La carica avviene tramite USB-C. Caricabatteria e cavetto inclusi.

Depending on the conditions of use for a recharge of approximately 4 hours, an autonomy of approximately 6 hours is estimated with 100% light intensity and approximately 24 hours with 25% light intensity. LED indicator for the load status. Charging takes place via USB-C. Battery charger and cable Included.

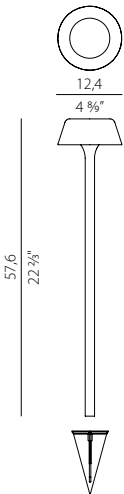

- PE07805.011.0514**
- PE07806.011.0514**
- PE07816.011.0514**
- PE07817.011.0514**
- PE07827.011.0514**
- PE07828.011.0514**
- PE07829.011.0514**

Potenza assorbita apparecchio / Luminaire power consumption 2W  
 Flusso luminoso apparecchio / Luminaire luminous flux 134lm  
 2700K Ra>90 5V DC battery Dimmable (Step DIM)

**IP65**

Fornito completo di picchetto di fissaggio al suolo, interruttore incluso  
 Supplied with peg to fix to the ground, switch included

In funzione delle condizioni di utilizzo per una ricarica di circa 4 ore si stima un'autonomia di circa 6 ore con intensità della luce al 100% e di circa 24 ore con intensità della luce al 25%. Indicatore LED per lo stato di carica. La carica avviene tramite USB-C. Caricabatteria e cavetto inclusi.

Depending on the conditions of use for a recharge of approximately 4 hours, an autonomy of approximately 6 hours is estimated with 100% light intensity and approximately 24 hours with 25% light intensity. LED indicator for the load status. Charging takes place via USB-C. Battery charger and cable Included.



reddot winner 2020

# FIREFLY IN THE SKY

Matteo Thun 2019

Registered Design

CODICE  
CODE  
**YRM07802.010**

FONTI LUMINOSE  
LIGHT SOURCES

kg

Vassoio per ricarica multipla di massimo 10 modelli Firefly in the Sky.  
Multiple charging tray for up to 10 Firefly in the Sky models.

4,03

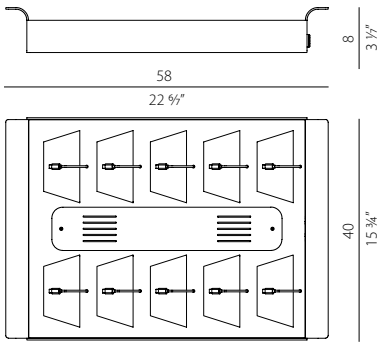

Fotometrie disponibili [www.panzeri.it](http://www.panzeri.it) / Photometric data available at [www.panzeri.it](http://www.panzeri.it)

## CODICI COLORI DISPONIBILI / COLOUR CODES AVAILABLE

**05** champagne  
champagne

**06** nero satinato  
mat black

**16** corten  
corten

**17** bronzo  
bronze

**27** verde oliva materico  
textured olive green

**28** bianco soft materico  
textured soft white

**29** terracotta naturale materico  
textured natural terracotta

**02** nero  
black







Lampada a sospensione, tavolo, terra e picchetto studiata per esterni. Paralume in rattan sintetico intrecciato a mano colore marrone e stelo in alluminio/ottone (versione da tavolo, terra e picchetto). Diffusore in policarbonato trasparente con portalampada E27. Diffusore con attacco a baionetta studiato per permettere una facile rimozione per l'eventuale ritiro del paralume durante l'inverno. Versione a sospensione fornita con 1 cavo di alimentazione in color arancione (versione da 90 equipaggiata anche con 1 cavo di sospensione in acciaio). Disponibili accessori per fissaggio a parete. Ideale per zone living esterne o illuminazione di giardini.

Outdoor lamp in the suspension, table, floor and peg versions. Lampshade in hand-woven synthetic brown rattan and body in aluminium/brass (table, floor and peg versions). Transparent polycarbonate diffuser with E27 lamp socket. Diffuser with bayonet fitting, designed for an easy removal of the lampshade during the winter. Suspended version supplied with 1 power cable in orange (version 90 also equipped with 1 suspension steel cable). Available accessories for wall fixing. Ideal for outdoor living areas or garden lighting.

	CODICE CODE	FONTI LUMINOSE LIGHT SOURCES	kg
<p>Versione con rosone IP20 Canopy version IP20</p>	<b>EL04744.035.0000</b>	LED retrofit bulb E27 (L max 125mm - Ø max 65mm) max 53W E27 <b>IP65</b> <input type="checkbox"/> Fornito completo di cavo di collegamento 4,5m, spina, rosone, o-ring in silicone, moschettone. IP65 solo versione con spina Supplied with 4,5m cable, plug, canopy, silicone o-ring, hook. IP65 only plug version	2,49
<p>Versione con O-Ring IP65 O-Ring version IP65</p>			







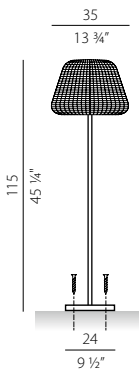

<p>Versione con rosone IP20 Canopy version IP20</p>	<b>EL04744.050.0000</b>	LED retrofit bulb E27 (L max 125mm - Ø max 65mm) max 53W E27 <b>IP65</b> <input type="checkbox"/> Fornito completo di cavo di collegamento 4,5m, spina, rosone, o-ring in silicone, moschettone. IP65 solo versione con spina Supplied with 4,5m cable, plug, canopy, silicone o-ring, hook. IP65 only plug version	4,16
<p>Versione con O-Ring IP65 O-Ring version IP65</p>			

<p>Versione con rosone IP20 Canopy version IP20</p>	<b>EL04744.090.0000</b>	LED retrofit bulb E27 (L max 125mm - Ø max 65mm) max 53W E27 <b>IP65</b> <input type="checkbox"/> Fornito completo di cavo di collegamento 4,5m, spina e rosone. IP65 solo versione con spina Supplied with 4,5m cable, plug and canopy. IP65 only plug version	11,37
<p>Versione con spina IP65 Version plug IP65</p>			

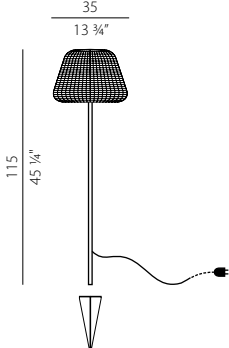
	<b>EC04744.035.0000</b>	LED retrofit bulb E27 (L max 125mm - Ø max 65mm) max 53W E27 <b>IP65</b> <input type="checkbox"/> Fornito con interruttore Supplied with switch	3,36
--	-------------------------	---	------

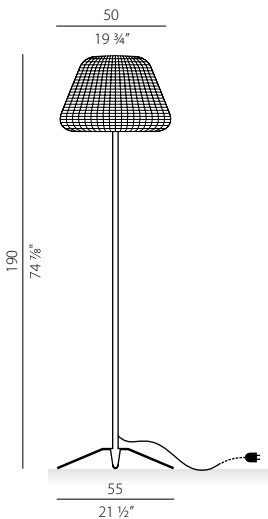
# RALPH

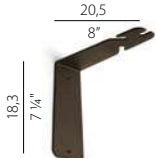
Officina Panzeri 2011

	CODICE CODE	FONTI LUMINOSE LIGHT SOURCES	kg
	<b>ET04744.035.0000</b>	LED retrofit bulb E27 (L max 125mm - Ø max 65mm) max 53W E27  <b>IP65</b>  Fornito completo di base. Da fissare al suolo Supplied complete with base. To be fixed to the ground	3,42
	<b>PE04744.035.0000</b>	LED retrofit bulb E27 (L max 125mm - Ø max 65mm) max 53W E27  <b>IP65</b>  Fornito completo di picchetto di fissaggio al suolo, spina e interruttore Supplied with peg to fix to the ground, plug and switch	3,84
	<b>ET04744.050.0000</b>	LED retrofit bulb E27 (L max 125mm - Ø max 65mm) max 53W E27  <b>IP65</b>  Fornito completo di base, interruttore e spina Supply with base, switch and plug	9,25
	<b>M4744 A</b>	Staffa per fissaggio a parete in alluminio plastificato. Accessorio per EL047__035.0000  Wall fixing bracket in plasticised aluminium. Accessory for EL047__035.0000	0,59
	<b>M47 T</b>	Picchetto per il fissaggio al suolo per ET047__050.0000. Peg for ground fixing for ET047__050.0000.	0,87

Fotometrie disponibili [www.panzeri.it](http://www.panzeri.it) / Photometric data available at [www.panzeri.it](http://www.panzeri.it)

## CODICI COLORI DISPONIBILI / COLOUR CODES AVAILABLE

**44** marrone metallizzato  
metallized brown





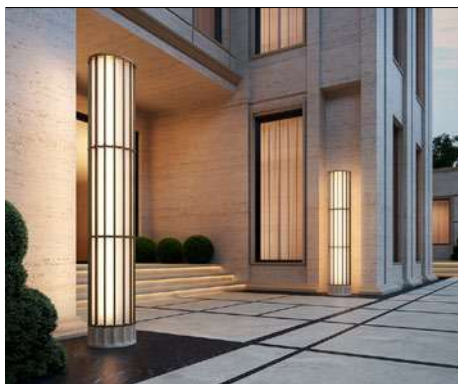

paralume marrone  
lampshade brown



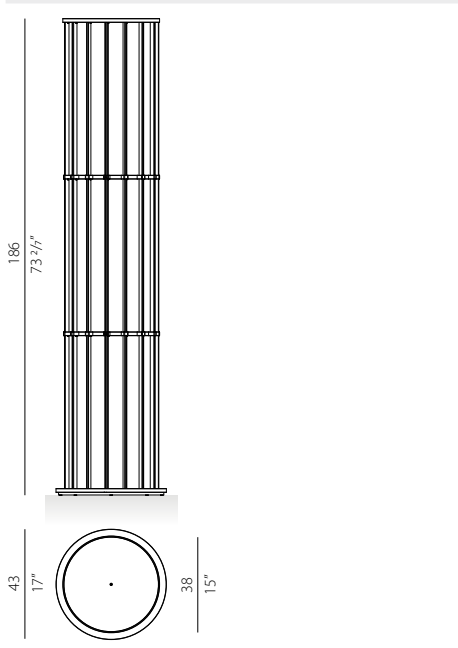

Una famiglia di prodotti che rappresenta un prestigioso connubio tra classicità e modernità. La sapiente unione di forme che evocano il passato, materiali raffinati e tecnologie contemporanee crea un prodotto senza tempo, in grado di esaltare la texture del vetro cattedrale attraverso una luce morbida e diffusa. Roma diventa assoluta protagonista dello spazio che occupa grazie al suo carattere forte e distintivo. Versione da terra per esterni. Completano la famiglia diverse versioni per interno.

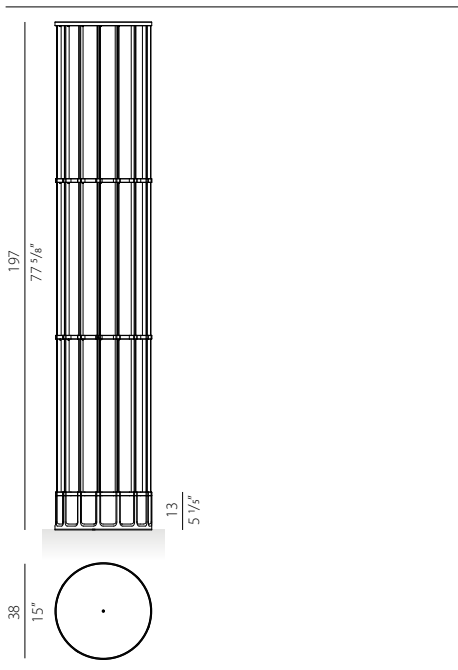
A family of products that represents a prestigious blend of classicism and modernity. The clever combination of shapes that evoke the past, refined materials and contemporary technology creates a timeless product that enhances the texture of cathedral glass through soft, diffused light. Roma becomes the absolute protagonist of the space it occupies thanks to its strong and distinctive character. Floor-standing version for outdoors. Several indoor versions complete the family.

NEW	CODICE CODE	FONTI LUMINOSE LIGHT SOURCES	kg
	<b>ET14817.185.0510</b>	Potenza assorbita apparecchio / Luminaire power consumption 70W Flusso luminoso apparecchio / Luminaire luminous flux 5400lm 2700K Ra>90 24V  <b>IP65</b>  Fornito completo di cavo 5m. Driver non incluso Supplied with 5m cable. Driver not included	56,00
	<b>ET14817.200.0510</b>	Potenza assorbita apparecchio / Luminaire power consumption 70W Flusso luminoso apparecchio / Luminaire luminous flux 5400lm 2700K Ra>90 24V  <b>IP65</b>  Basamento in travertino. Fornito completo di cavo 5m. Driver non incluso Travertine base. Supplied with 5m cable Driver not included	72,00

Fotometrie disponibili [www.panzeri.it](http://www.panzeri.it) / Photometric data available at [www.panzeri.it](http://www.panzeri.it)

CODICI COLORI DISPONIBILI / COLOUR CODES AVAILABLE

**17** bronzo  
bronze



Lampada a sospensione, parete e paletto per esterni IP65 con testa in vetro colato e piattello in alluminio tornito. Paletto in alluminio disponibile in tre altezze, completo di sistema di fissaggio per installazione a terra. Versione parete con braccio rigido di fissaggio a parete. Finiture grigio micaceo, legno verniciato con accessori in ottone satinato, corten. Ideale per hotel, ristoranti, residenze.

Suspension, wall lamp and bollard for outdoor IP65 with cast glass head and turned aluminium plate. Bollard available in three heights, complete with fixing system for ground installation. Wall version with fixed wall arm. Micaceous grey, varnished wood with mat brass accessories and corten finishes are available. Ideal for hotels, restaurants, residences.

	CODICE CODE	FONTI LUMINOSE LIGHT SOURCES	kg
	<b>ET04816.045.0201</b> <b>ET04834.045.0201</b> <b>ET04845.045.0201</b>	Potenza assorbita apparecchio / Luminaire power consumption 8W Flusso luminoso apparecchio / Luminaire luminous flux 594lm 2700K Ra>80 220-240V AC ON-OFF IP65	3,43
	<b>ET04816.070.0201</b> <b>ET04834.070.0201</b> <b>ET04845.070.0201</b>	Potenza assorbita apparecchio / Luminaire power consumption 8W Flusso luminoso apparecchio / Luminaire luminous flux 594lm 2700K Ra>80 220-240V AC ON-OFF IP65	3,70
	<b>ET04816.095.0201</b> <b>ET04834.095.0201</b> <b>ET04845.095.0201</b>	Potenza assorbita apparecchio / Luminaire power consumption 8W Flusso luminoso apparecchio / Luminaire luminous flux 594lm 2700K Ra>80 220-240V AC ON-OFF IP65	3,82
	<b>YTF04800.012</b>	Tirafondi per il fissaggio al suolo. Anchor bolts for ground fixing.	0,22

# VENEXIA

Matteo Thun 2020

	CODICE CODE	FONTI LUMINOSE LIGHT SOURCES	kg
	<b>EL04816.022.0201</b> <b>EL04819.022.0201</b> <b>EL04834.022.0201</b>	Potenza assorbita apparecchio / Luminaire power consumption 8W Flusso luminoso apparecchio / Luminaire luminous flux 594lm 2700K Ra>80 220-240V AC ON-OFF <b>LED IP65 IK06</b>	3,40
	<b>EA04816.022.0201</b> <b>EA04819.022.0201</b> <b>EA04834.022.0201</b>	Potenza assorbita apparecchio / Luminaire power consumption 8W Flusso luminoso apparecchio / Luminaire luminous flux 594lm 2700K Ra>80 220-240V AC ON-OFF <b>LED IP65 IK06</b>	3,60
		<b>EA04816.022.0201</b> <b>EA04819.022.0201</b> <b>EA04834.022.0201</b>	Potenza assorbita apparecchio / Luminaire power consumption 8W Flusso luminoso apparecchio / Luminaire luminous flux 594lm 2700K Ra>80 220-240V AC ON-OFF <b>LED IP65 IK06</b>

Fotometrie disponibili [www.panzeri.it](http://www.panzeri.it) / Photometric data available at [www.panzeri.it](http://www.panzeri.it)

## CODICI COLORI DISPONIBILI / COLOUR CODES AVAILABLE

- |                            |  |   |  |
|----------------------------|--|---|--|
| <b>16</b> corten<br>corten | <b>34</b> grigio micaceo<br>micaceous grey | <b>45</b> legno/ottone satinato<br>wood/mat brass | <b>19</b> ottone satinato<br>mat brass |
|----------------------------|--|---|--|



## PROFILI / PROFILES

136	BROADWAY
117	BRONX
119	BROOKLYN
123	BROOKLYN OUT
121	BROOKLYN TRIM
125	CORNER
127	GIANO
130	HARLEM
132	KIPS
131	KIPS ROUND
133	MANHATTAN
137	NOOK
138	TRIBECA



# BRONX XG247

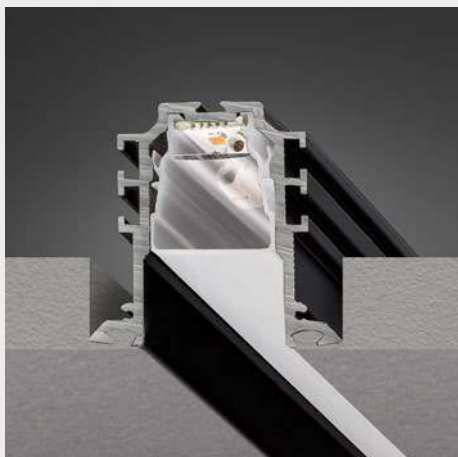

Profilo in alluminio estruso ad incasso, completo di diffusore in policarbonato estruso, studiato per consentire l'installazione su pannelli in cartongesso di diverso spessore (12,5mm e 25mm), grazie alla possibilità di posizionare gli elementi di fissaggio su due livelli. La sorgente luminosa è inserita a scorrimento senza incollaggio all'interno del diffusore in policarbonato estruso rimovibile a scatto, permettendo una semplice installazione.

Bronx is a recessed aluminium profile, characterized by the recessed positioning of the light source, and by a thin line of light of only 29 mm. The extrusion is designed to allow installation both on standard plasterboard panels and on panels with double thickness, thanks to the possibility of positioning the fixing tabs on two different levels. The light source is sliding inside the extruded polycarbonate diffuser without gluing, removable by snap, allowing a simple installation.

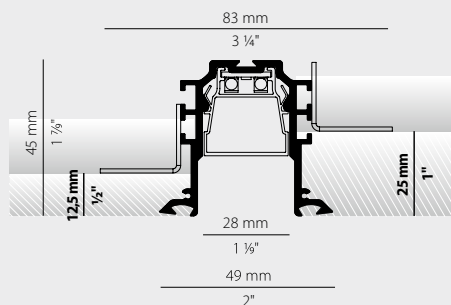

Electric options only with remote components page 188

Dimming / Power supply 192/193

Technical information 193

Wiring diagram 1 193

UGR <19 depending on installation conditions

Photometric data available at [www.panzeri.it](http://www.panzeri.it)

CODICE  
CODE

FONTI LUMINOSE  
LIGHT SOURCES

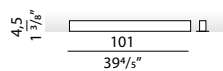

**KG247\_\_100.0410**

Potenza assorbita apparecchio / Luminaire power consumption 17,2W  
Flusso luminoso apparecchio / Luminaire luminous flux 915lm  
3000K Ra>90 24V DC

IP40 IP20

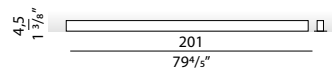

**KG247\_\_200.0410**

Potenza assorbita apparecchio / Luminaire power consumption 34,4W  
Flusso luminoso apparecchio / Luminaire luminous flux 1830lm  
3000K Ra>90 24V DC

IP40 IP20

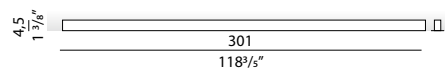

**KG247\_\_300.0410**

Potenza assorbita apparecchio / Luminaire power consumption 51,6W  
Flusso luminoso apparecchio / Luminaire luminous flux 2745lm  
3000K Ra>90 24V DC

IP40 IP20

Forniti completi di LED, tappi di chiusura, staffe di fissaggio per installazione in cartongesso e schermo diffusore in policarbonato opalino.

Supplied complete with LED, end caps, fixing brackets for drywall installation and opal polycarbonate diffuser screen.

## CODICI COLORI DISPONIBILI / COLOUR CODES AVAILABLE

**01** bianco  
white

**02** nero  
black

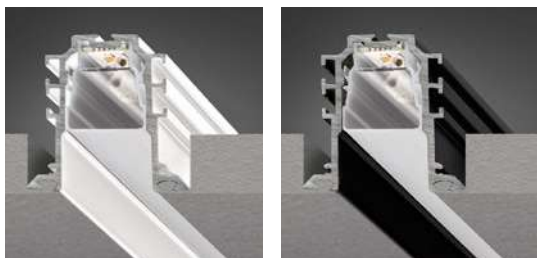

**XM24701.302.0099****XM24702.302.0099**

Elemento di collegamento per due linee di profili componibili con angolo di giunzione piano di 90°, per installazione incassata a scomparsa.  
 Connection joint for two lines of modular profiles with level junction 90°, for total built-in installation.

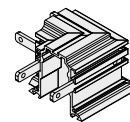

0,10

**XM24700.301.0099**

Kit di giunzione lineare.  
 Linear junction kit.

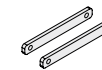

0,03

**XM2033/34/32/31-S**

Cavi di alimentazione.  
 Power cables.



0,01

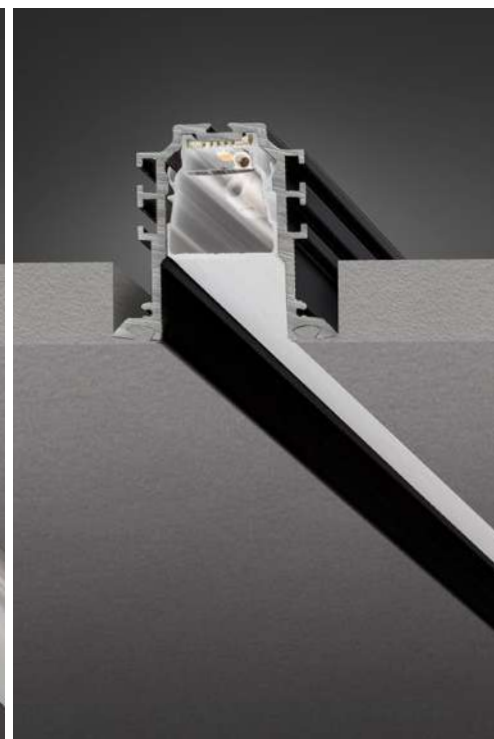
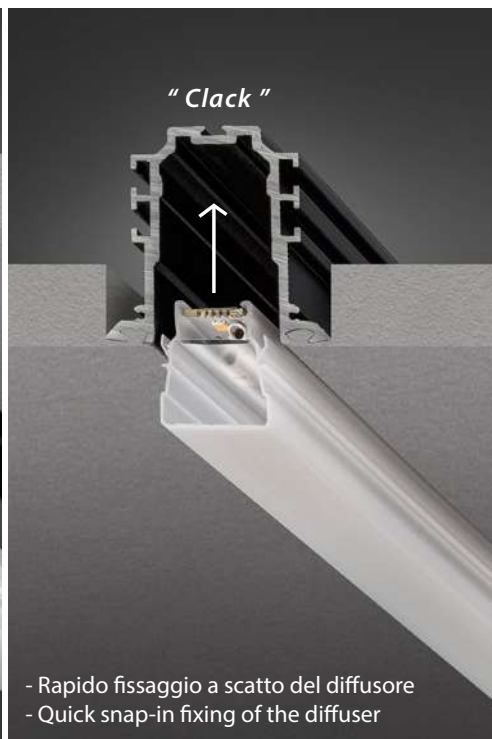
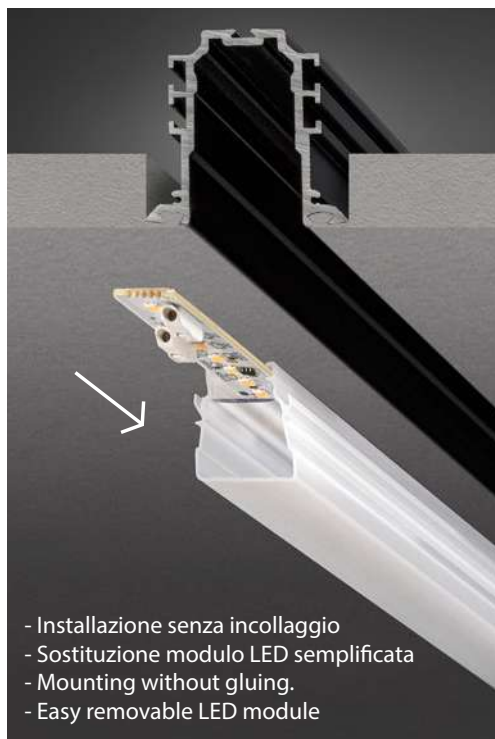

**L'Ufficio Tecnico Panzeri è disponibile a supporto della progettazione / Panzeri Technical Department is available to support the design**





# BROOKLYN

## XG2033



Sistema modulare LED in alluminio estruso verniciato bianco sezionabile, da incasso a scomparsa totale (trimless), per applicazioni in verticale o orizzontale per cartongesso/laterizio. Doppi schermi: il primo monouso per rasatura, stuccatura e verniciatura, il secondo definitivo opalino o microprismato. Per una corretta e facile installazione nel cartongesso sono disponibili farfalle micro regolabili opzionali, applicabili ogni 400mm ca. Moduli LED multipli da 500mm frazionabili ogni 62,5mm 3000K 8,6W 24V. Moduli LED da 125mm 3000K 2,2W 24V, completi di 2 cavetti per collegamento. Predisporre, se necessari, eventuali appendimenti.

Modular LED system in white painted extruded aluminium (trimless), dividable, and fully recessed wall for vertical or horizontal use in drywall/concrete. Two screens: the first disposable for shaving, plastering and painting, the second definitive in opaline or microprismatic finish. For a quick and easy installation in drywall, are available micro adjustable wings nut optional, applicable every 400mm approx. Multiple LED modules (500mm long) divisible every 62,5mm 3000K 8,6W 24V. Modules (125mm long) 3000K 2,2W 24V, complete with 2 connection cables. Prepare, if necessary, any hangings to support the system.

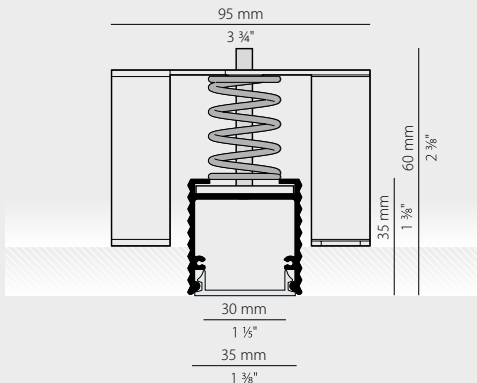

Electric options only with remote components	page 188
Dimming / Power supply	192/193
Technical information	193
Wiring diagram 1	193
UGR <19 depending on installation conditions	
Photometric data available at <a href="http://www.panzeri.it">www.panzeri.it</a>	

CODICE  
CODE

FONTI LUMINOSE  
LIGHT SOURCES

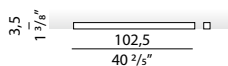

**KG23301.100.0410**

Potenza assorbita apparecchio / Luminaire power consumption 17,2W  
Flusso luminoso apparecchio / Luminaire luminous flux 1142lm  
3000K Ra>90 24V DC

IP40 IP20

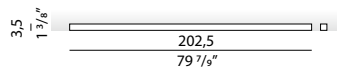

**KG23301.200.0410**

Potenza assorbita apparecchio / Luminaire power consumption 34,4W  
Flusso luminoso apparecchio / Luminaire luminous flux 2284lm  
3000K Ra>90 24V DC

IP40 IP20

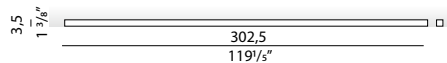

**KG23301.300.0410**

Potenza assorbita apparecchio / Luminaire power consumption 51,6W  
Flusso luminoso apparecchio / Luminaire luminous flux 3426lm  
3000K Ra>90 24V DC

IP40 IP20

Forniti completi di LED, tappi di chiusura, farfalle di fissaggio per istallazione in cartongesso e schermo diffusore in policarbonato opalino.

Supplied complete with LED, end caps, fixing brackets for drywall installation and opal polycarbonate diffuser screen.

Fotometrie disponibili [www.panzeri.it](http://www.panzeri.it) / Photometric data available at [www.panzeri.it](http://www.panzeri.it)

CODICI COLORI DISPONIBILI / COLOUR CODES AVAILABLE

**01** bianco  
white

L'Ufficio Tecnico Panzeri è disponibile a supporto della progettazione / Panzeri Technical Department is available to support the design

ACCESSORI / ACCESSORIES

**XM2033/34-WHI**

Riflettore bianco di lunghezza 1000mm (39,4") sezionabile.  
White reflector with 1000mm (39,4") length to be cut.

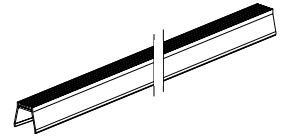

kg  
0,23

**XM2033/34-L**

Coppia di piastrine di fissaggio per incasso in muratura.  
Pair of fixing plates for recessed installation in brick wall or concrete.



0,04

**XM2033/34/38/39P**

Piastrina per appendimento.  
Plate for hanging.



0,01

**XM2033-U90**

Elemento di collegamento per due linee di profili componibili con angolo di giunzione piano di 90°, per installazione a incasso a scomparsa.  
Connection joint for two lines of modular profiles with level junction 90°, for total built-in installation.

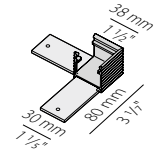

0,11

**XM2033-UT**

Giunzione piana per tre profili a "T", per installazione a incasso a scomparsa.  
Three profiles "T" level junction, for total built-in installation.

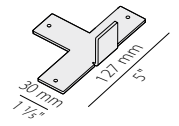

0,17

**XM2033-X**

Giunzione piana per quattro profili a "X", per installazione a incasso a scomparsa.  
Four profiles "X" level junction, for total built-in installation.

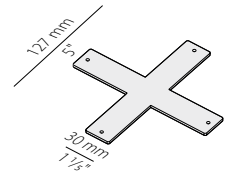

0,16

**XM2033/34-ANG**

Giunzione perpendicolare per due profili con taglio a 45°.  
Two profiles perpendicular junction with 45° cut.

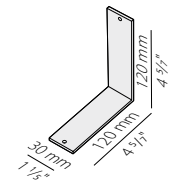

0,15

**XM2033/34-U**

Giunzione lineare.  
Linear junction.

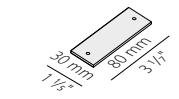

0,06

**XM2033/34/32/31-S**

Cavi di alimentazione.  
Power cables.



0,01

**DIFFUSERS**

CODICE / CODE	L MM	L INCHES		kg
<b>YDM23301.110</b>	1100 x 30	43 1/8" x 1 1/8"	Schermo diffusore in policarbonato estruso microprismatico, di lunghezza 1100mm (43,3"). Microprismatic extruded polycarbonate diffuser, 1100mm (43,3") long.	0,08
<b>YDM23301.210</b>	2100 x 30	82 3/4" x 1 1/8"	Schermo diffusore in policarbonato estruso microprismatico, di lunghezza 2100mm (82,7"). Microprismatic extruded polycarbonate diffuser, 2100mm (82,7") long.	0,16
<b>YDM23301.310</b>	3100 x 30	122 1/2" x 1 1/8"	Schermo diffusore in policarbonato estruso microprismatico, di lunghezza 3100mm (122"). Microprismatic extruded polycarbonate diffuser, 3100mm (122") long.	0,24
<b>XM2033/34/45/46-600S PR</b>	6000 x 30	236 3/8" x 1 1/8"	Schermo diffusore in policarbonato estruso microprismatico, di lunghezza 6000mm (236,2"). Micro-prismatic extruded polycarbonate diffuser, 6000mm (236,2") long.	0,47
<b>XM2033/34/45/46-900S PR</b>	9000 x 30	354 3/8" x 1 1/8"	Schermo diffusore in policarbonato estruso microprismatico, di lunghezza 9000mm (354,3"). Micro-prismatic extruded polycarbonate diffuser, 9000mm (354,3") long.	0,69
<b>XM2033/34/45/46-1200S PR</b>	12000 x 30	472 1/8" x 1 1/8"	Schermo diffusore in policarbonato estruso microprismatico, di lunghezza 12000mm (472,4"). Micro-prismatic extruded polycarbonate diffuser, 12000mm (472,4") long.	0,93
<b>XM2033/34/45/46-600S</b>	6000 x 30	236 3/8" x 1 1/8"	Schermo diffusore in policarbonato estruso con finitura opalina, di lunghezza 6000mm (236,2"). Extruded polycarbonate diffuser with opaline finish, 6000mm (236,2") long.	0,47
<b>XM2033/34/45/46-900S</b>	9000 x 30	354 3/8" x 1 1/8"	Schermo diffusore in policarbonato estruso con finitura opalina, di lunghezza 9000mm (354,3"). Extruded polycarbonate diffuser with opaline finish, 9000mm (354,3") long.	0,69
<b>XM2033/34/45/46-1200S</b>	12000 x 30	472 1/8" x 1 1/8"	Schermo diffusore in policarbonato estruso con finitura opalina, di lunghezza 12000mm (472,4"). Extruded polycarbonate diffuser with opaline finish, 12000mm (472,4") long.	0,93



# BROOKLYN TRIM

## XG2034



Sistema modulare LED in alluminio estruso verniciato bianco sezionabile, da incasso con bordo (trim), per applicazioni in verticale o orizzontale per cartongesso/laterizio. Per una corretta e facile installazione nel cartongesso sono disponibili farfalle opzionali, applicabili ogni 400mm ca. Moduli LED multipli da 500mm frazionabili ogni 62,5mm 3000K 8,6W 24V. Moduli LED da 125mm 3000K 2,2W 24V, completi di 2 cavetti per collegamento. Predisporre, se necessari, eventuali appendimenti.

Modular LED system in extruded aluminium painted white, for recessed installation with border (trim), for vertical or horizontal application in drywall /brick. Wings nut (an optional) are available for correct and simple installation in false ceiling applicable every 400mm approx. Multiple 500mm LED modules 8,6W 24V 3000K divisible every 62,5mm. 125mm LED modules 3000k 2,2W 24V complete with 2 connection cable. Prepare any suspensions, if necessary.

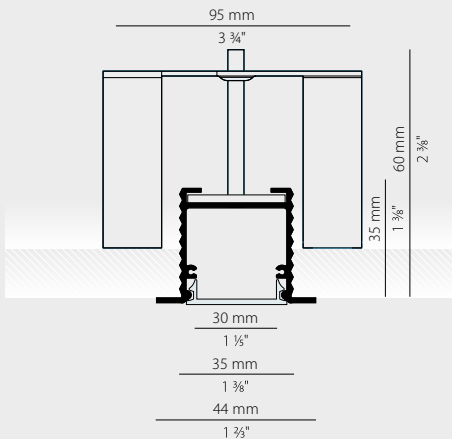

Electric options only with remote components	page 188
Dimming / Power supply	192/193
Technical information	193
Wiring diagram 1	193
UGR <19 depending on installation conditions	
Photometric data available at <a href="http://www.panzeri.it">www.panzeri.it</a>	

CODICE  
CODE

FONTI LUMINOSE  
LIGHT SOURCES

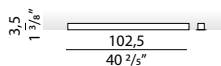

**KG23401.100.0410**

Potenza assorbita apparecchio / Luminaire power consumption 17,2W  
Flusso luminoso apparecchio / Luminaire luminous flux 1142lm  
3000K Ra>90 24V DC

IP40 IP20

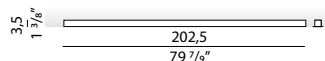

**KG23401.200.0410**

Potenza assorbita apparecchio / Luminaire power consumption 34,4W  
Flusso luminoso apparecchio / Luminaire luminous flux 2284lm  
3000K Ra>90 24V DC

IP40 IP20

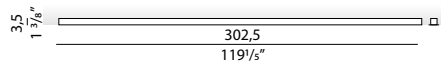

**KG23401.300.0410**

Potenza assorbita apparecchio / Luminaire power consumption 51,6W  
Flusso luminoso apparecchio / Luminaire luminous flux 3426lm  
3000K Ra>90 24V DC

IP40 IP20

Forniti completi di LED, tappi di chiusura, farfalle di fissaggio per istallazione in cartongesso e schermo diffusore in policarbonato opalino.

Supplied complete with LED, end caps, fixing brackets for drywall installation and opal polycarbonate diffuser screen.

Fotometrie disponibili [www.panzeri.it](http://www.panzeri.it) / Photometric data available at [www.panzeri.it](http://www.panzeri.it)

CODICI COLORI DISPONIBILI / COLOUR CODES AVAILABLE

**01** bianco  
white

## ACCESSORI / ACCESSORIES

**XM2033/34-WHI**

Riflettore bianco di lunghezza 1000mm (39,4") sezionabile.  
White reflector with 1000mm (39,4") length to be cut.

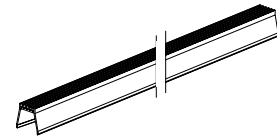
kg  
0,23**XM2033/34-L**

Coppia di piastrelle di fissaggio per incasso in muratura.  
Pair of fixing plates for recessed installation in brick wall or concrete.



0,04

**XM2033/34/38/39P**

Piastrina per appendimento.  
Plate for hanging.



0,01

**XM2034-U90**

Elemento di collegamento per due linee di profili componibili con angolo di giunzione piano di 90°, per installazione a incasso.  
Connection joint for two lines of modular profiles with level junction 90°, for built-in installation.

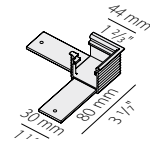

0,22

**XM2033/34-ANG**

Giunzione perpendicolare per due profili con taglio a 45°.  
Two profiles perpendicular junction with 45° cut.

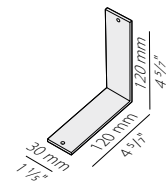

0,15

**XM2033/34-U**

Giunzione lineare.  
Linear junction.

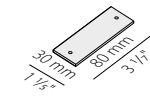

0,06

**XM2033/34/32/31-S**

Cavi di alimentazione.  
Power cables.



0,01

**DIFFUSERS**

CODICE / CODE	L MM	L INCHES		kg
<b>YDM23301.110</b>	1100 x 30	43 1/8" x 1 1/8"	Schermo diffusore in policarbonato estruso microprismato, di lunghezza 1100mm (43,3"). Microprismatic extruded polycarbonate diffuser, 1100mm (43,3") long.	0,08
<b>YDM23301.210</b>	2100 x 30	82 3/4" x 1 1/8"	Schermo diffusore in policarbonato estruso microprismato, di lunghezza 2100mm (82,7"). Microprismatic extruded polycarbonate diffuser, 2100mm (82,7") long.	0,16
<b>YDM23301.310</b>	3100 x 30	122 1/2" x 1 1/8"	Schermo diffusore in policarbonato estruso microprismato, di lunghezza 3100mm (122"). Microprismatic extruded polycarbonate diffuser, 3100mm (122") long.	0,24
<b>XM2033/34/45/46-600S PR</b>	6000 x 30	236 3/8" x 1 1/8"	Schermo diffusore in policarbonato estruso microprismatico, di lunghezza 6000mm (236,2"). Micro-prismatic extruded polycarbonate diffuser, 6000mm (236,2") long.	0,47
<b>XM2033/34/45/46-900S PR</b>	9000 x 30	354 3/8" x 1 1/8"	Schermo diffusore in policarbonato estruso microprismatico, di lunghezza 9000mm (354,3"). Micro-prismatic extruded polycarbonate diffuser, 9000mm (354,3") long.	0,69
<b>XM2033/34/45/46-1200S PR</b>	12000 x 30	472 4/8" x 1 1/8"	Schermo diffusore in policarbonato estruso microprismatico, di lunghezza 12000mm (472,4"). Micro-prismatic extruded polycarbonate diffuser, 12000mm (472,4") long.	0,93
<b>XM2033/34/45/46-600S</b>	6000 x 30	236 3/8" x 1 1/8"	Schermo diffusore in policarbonato estruso con finitura opalina, di lunghezza 6000mm (236,2"). Extruded polycarbonate diffuser with opaline finish, 6000mm (236,2") long.	0,47
<b>XM2033/34/45/46-900S</b>	9000 x 30	354 3/8" x 1 1/8"	Schermo diffusore in policarbonato estruso con finitura opalina, di lunghezza 9000mm (354,3"). Extruded polycarbonate diffuser with opaline finish, 9000mm (354,3") long.	0,69
<b>XM2033/34/45/46-1200S</b>	12000 x 30	472 4/8" x 1 1/8"	Schermo diffusore in policarbonato estruso con finitura opalina, di lunghezza 12000mm (472,4"). Extruded polycarbonate diffuser with opaline finish, 12000mm (472,4") long.	0,93

L'Ufficio Tecnico Panzeri è disponibile a supporto della progettazione / Panzeri Technical Department is available to support the design



# BROOKLYN OUT

## XP2033







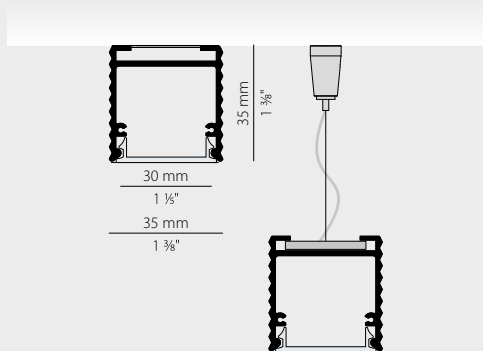

Sistema modulare LED in alluminio estruso verniciato bianco (nero a richiesta) sezionabile, da parete/plafone o a sospensione. Moduli LED multipli da 500mm frazionabili ogni 62,5mm 3000K 8,6W 24V. Moduli LED da 125mm 3000K 2,2W 24V, completi di 2 cavetti per collegamento.

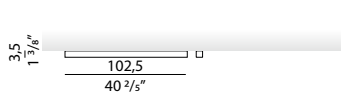
Modular LED system in extruded aluminium painted white for wall/ ceiling or suspension (black on request). 500mm Multiple LED modules 8,6W 24V 3000K divisible in 62,5mm sections. 125mm LED modules 3000K 2,2W 24V, complete with 2 connection cables.

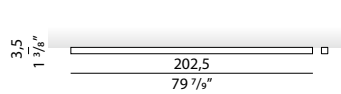

Electric options only with remote components	page 188
Dimming / Power supply	192-193
Technical information	193
Wiring diagram 1	193
UGR <19 depending on installation conditions	
Photometric data available at <a href="http://www.panzeri.it">www.panzeri.it</a>	

	CODICE CODE	FONTI LUMINOSE LIGHT SOURCES
	<b>KP23301.100.0410</b>	Potenza assorbita apparecchio / Luminaire power consumption 17,2W Flusso luminoso apparecchio / Luminaire luminous flux 1142lm 3000K Ra>90 24V DC  <b>IP40 IP20</b>
	<b>KP23301.200.0410</b>	Potenza assorbita apparecchio / Luminaire power consumption 34,4W Flusso luminoso apparecchio / Luminaire luminous flux 2284lm 3000K Ra>90 24V DC  <b>IP40 IP20</b>
	<b>KP23301.300.0410</b>	Potenza assorbita apparecchio / Luminaire power consumption 51,6W Flusso luminoso apparecchio / Luminaire luminous flux 3426lm 3000K Ra>90 24V DC  <b>IP40 IP20</b>  Forniti completi di LED, tappi di chiusura, e schermo diffusore in policarbonato opalino. Supplied complete with LED, end caps and opal polycarbonate diffuser screen.

Fotometrie disponibili [www.panzeri.it](http://www.panzeri.it) / Photometric data available at [www.panzeri.it](http://www.panzeri.it)

CODICI COLORI DISPONIBILI / COLOUR CODES AVAILABLE

**01** bianco  
white

L'Ufficio Tecnico Panzeri è disponibile a supporto della progettazione / Panzeri Technical Department is available to support the design

ACCESSORI / ACCESSORIES

### XM2033/34-WHI

Riflettore bianco di lunghezza 1000mm (39,4") sezionabile.  
White reflector with 1000mm (39,4") length to be cut.

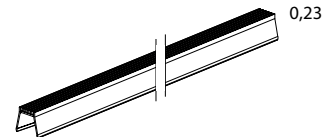

kg

0,23

### XM-KIT-S

Kit di sospensione singolo, con fune di acciaio di lunghezza 2000mm (78 7/8").  
Single suspension kit, with 2000mm (78 7/8") long steel wire.

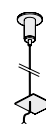

0,05

### XM231/32-P

Distanziale per installazione a soffitto/parete.  
Spacer for ceiling/wall installation.



0,08

**XM2033-U90 XP**

Elemento di collegamento per due linee di profili componibili con angolo di giunzione piano di 90°, per installazione a sospensione o a soffitto.  
Connection joint for two lines of modular profiles with level junction 90°, for suspended or ceiling installation.

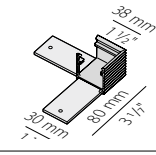

0,11

**XM2033/34-ANG**

Giunzione perpendicolare per due profili con taglio a 45°.  
Two profiles perpendicular junction with 45° cut.

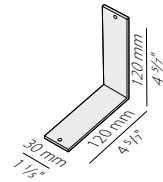

0,15

**XM2033/34-U**

Giunzione lineare.  
Linear junction.

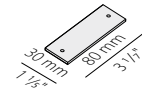

0,06

**XM2033-A**

Coppia di copriluce adesivi per giunzioni.  
Pair of adhesive light covers for junctions.

**XM2033-T120W**

Kit di alimentazione con rosone bianco e alimentatore 120W.  
Power supply kit with white canopy and 120W driver.

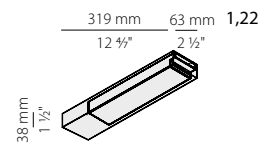

1,22

**XM2033-T150W DIM**

Kit di alimentazione con rosone bianco e alimentatore 150W dimmerabile DALI/ Push DIM.  
Power supply kit with white canopy and 150W DALI/ Push DIM dimmable driver.

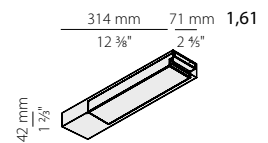

1,61

**XM2033-ST120W**

Kit di alimentazione con rosone bianco, alimentatore 120W, cavo di alimentazione di lunghezza 2,2m (86,6").  
Power supply kit with white canopy, 120W driver, power cable with length 2,2m (86,6").

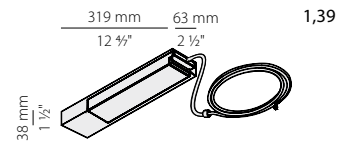

1,39

**XM2033-ST150W DIM**

Kit di alimentazione con rosone bianco, alimentatore 150W dimmerabile DALI/ Push DIM, cavo di alimentazione di lunghezza 2,2m (86,6").  
Power supply kit with white canopy, 150W DALI/ Push DIM dimmable driver, power cable with length 2,2m (86,6").

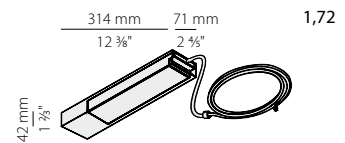

1,72

**XM2033/34/32/31-S**

Cavi di alimentazione / Power cables.



0,01

**DIFFUSERS**

CODICE / CODE	L MM	L INCHES		kg
<b>YDM23301.110</b>	1100 x 30	43 1/8" x 1 1/8"	Schermo diffusore in policarbonato estruso microprismato, di lunghezza 1100mm (43,3"). Microprismatic extruded polycarbonate diffuser, 1100mm (43,3") long.	0,08
<b>YDM23301.210</b>	2100 x 30	82 3/4" x 1 1/8"	Schermo diffusore in policarbonato estruso microprismato, di lunghezza 2100mm (82,7"). Microprismatic extruded polycarbonate diffuser, 2100mm (82,7") long.	0,16
<b>YDM23301.310</b>	3100 x 30	122 1/2" x 1 1/8"	Schermo diffusore in policarbonato estruso microprismato, di lunghezza 3100mm (122"). Microprismatic extruded polycarbonate diffuser, 3100mm (122") long.	0,24
<b>XM2033/34/45/46-600S PR</b>	6000 x 30	236 3/8" x 1 1/8"	Schermo diffusore in policarbonato estruso microprismato, di lunghezza 6000mm (236,2"). Micro-prismatic extruded polycarbonate diffuser, 6000mm (236,2") long.	0,47
<b>XM2033/34/45/46-900S PR</b>	9000 x 30	354 3/8" x 1 1/8"	Schermo diffusore in policarbonato estruso microprismato, di lunghezza 9000mm (354,3"). Micro-prismatic extruded polycarbonate diffuser, 9000mm (354,3") long.	0,69
<b>XM2033/34/45/46-1200S PR</b>	12000 x 30	472 4/8" x 1 1/8"	Schermo diffusore in policarbonato estruso microprismato, di lunghezza 12000mm (472,4"). Micro-prismatic extruded polycarbonate diffuser, 12000mm (472,4") long.	0,93
<b>XM2033/34/45/46-600S</b>	6000 x 30	236 3/8" x 1 1/8"	Schermo diffusore in policarbonato estruso con finitura opalina, di lunghezza 6000mm (236,2"). Extruded polycarbonate diffuser with opaline finish, 6000mm (236,2") long.	0,47
<b>XM2033/34/45/46-900S</b>	9000 x 30	354 3/8" x 1 1/8"	Schermo diffusore in policarbonato estruso con finitura opalina, di lunghezza 9000mm (354,3"). Extruded polycarbonate diffuser with opaline finish, 9000mm (354,3") long.	0,69
<b>XM2033/34/45/46-1200S</b>	12000 x 30	472 4/8" x 1 1/8"	Schermo diffusore in policarbonato estruso con finitura opalina, di lunghezza 12000mm (472,4"). Extruded polycarbonate diffuser with opaline finish, 12000mm (472,4") long.	0,93



# CORNER XG2045



XG2045-\_\_+LED+XM2045-T

Sistema modulare a soffitto o parete caratterizzato dal posizionamento arretrato della sorgente. L'installazione prevede l'ancoraggio alle superfici perimetrali e l'inserimento finale del pannello in cartongesso a filo con l'estruso, per un effetto di luce a scomparsa.

Modular LED system in extruded aluminum white painted, for wall or ceiling perimeter installation, characterized by the back positioning of the light source. The installation foresees the fixation of profiles to side surfaces and the final placing of plasterboard panel flush with the extruded body, to have a total recessed light effect.

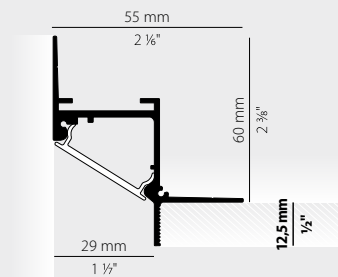

Electric options only with remote components page 188

Dimming / Power supply 192/193

Technical information 193

Wiring diagram 1-2 193

UGR <19 depending on installation conditions

Photometric data available at [www.panzeri.it](http://www.panzeri.it)

## TRIMLESS PROFILE

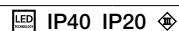

	CODICE / CODE	L MM	L INCHES	kg
Fornito completo di schermo diffusore	<b>XG2045-50TRACK</b>	510	20"	0,45
Supplied with diffuser	<b>XG2045-100TRACK</b>	1010	39 3/8"	0,78
	<b>XG2045-200TRACK</b>	2010	79 1/8"	1,45
	<b>XG2045-300TRACK</b>	3010	118 3/8"	2,05

## LED MODULE



	CODICE / CODE	L MM	L INCHES	MM	INCHES	W	W/M	LM	LM/M	NR. LED	LED	V
	<b>XM006.050.0410</b>	500	19 3/8"	62,5	2 1/2"	8,6W	17,2W/m	1140lm	2280lm/m	64	3000K Ra>90	24V DC
	<b>XM006.012.0410</b>	125	5"	62,5	2 1/2"	2,15W	17,2W/m	258lm	2280lm/m	16	3000K Ra>90	24V DC
	<b>YLR005.010.0410</b>	5000	197"	50	2"		9,6W/m		1220lm/m	200/m	3000K Ra>80	24V DC
	<b>YLR006.017.0410</b>	5000	197"	42	1 3/8"		16,8W/m		2070lm/m	200/m	3000K Ra>90	24V DC
	<b>YLR007.022.0410</b>	5000	197"	42	1 3/8"		22W/m		2700lm/m	240/m	3000K Ra>90	24V DC

Altre temperature di colore disponibili a pag. 188 / Other colour temperatures available on page 188

Matrice di compatibilità LED / Profili pag. 139 / LED Profile Matrix page 139

## DIFFUSERS

CODICE / CODE	L MM	L INCHES		kg
<b>XM2033/34/45/46-600S</b>	6000 x 30	236 3/8" x 1 1/8"	Schermo diffusore in policarbonato estruso con finitura opalina, di lunghezza 6000mm (236,2"). Extruded polycarbonate diffuser with opaline finish, 6000mm (236,2") long.	0,47
<b>XM2033/34/45/46-900S</b>	9000 x 30	354 3/8" x 1 1/8"	Schermo diffusore in policarbonato estruso con finitura opalina, di lunghezza 9000mm (354,3"). Extruded polycarbonate diffuser with opaline finish, 9000mm (354,3") long.	0,69
<b>XM2033/34/45/46-1200S</b>	12000 x 30	472 4/8" x 1 1/8"	Schermo diffusore in policarbonato estruso con finitura opalina, di lunghezza 12000mm (472,4"). Extruded polycarbonate diffuser with opaline finish, 12000mm (472,4") long.	0,93

Fotometrie disponibili [www.panzeri.it](http://www.panzeri.it) / Photometric data available at [www.panzeri.it](http://www.panzeri.it)

CODICI COLORI DISPONIBILI / COLOUR CODES AVAILABLE

01 bianco  
white

**XM2045-U90 1**

Elemento di collegamento per due linee di profili componibili con angolo di giunzione piano interno di 90°, per installazione perimetrale.  
Connection joint for two lines of modular profiles with internal level junction 90°, for perimetral installation.

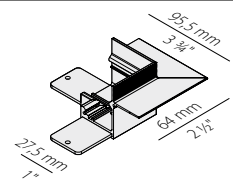

0,09

**XM2045-U90 2**

Elemento di collegamento per due linee di profili componibili con angolo di giunzione piano esterno di 90°, per installazione perimetrale.  
Connection joint for two lines of modular profiles with external level junction 90°, for perimetral installation.

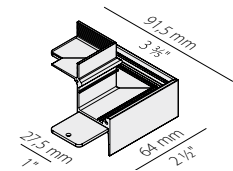

0,13

**XM2045-ANG 3**

Elemento di collegamento per due linee di profili componibili con angolo di giunzione perpendicolare interno di 90°, per installazione perimetrale.  
Connection joint for two lines of modular profiles with internal perpendicular junction 90°, for perimetral installation.

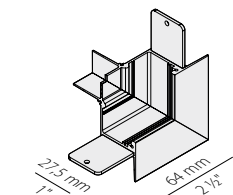

0,11

**XM2045-ANG 4**

Elemento di collegamento per due linee di profili componibili con angolo di giunzione perpendicolare esterno di 90°, per installazione perimetrale.  
Connection joint for two lines of modular profiles with external perpendicular junction 90°, for perimetral installation.

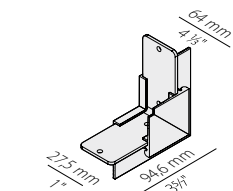

0,09

**XM2045-U**

Giunzione lineare.  
Linear junction.

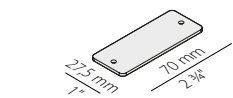

0,03

**XM2045-T**

Coppia di testate di chiusura con viti.  
Pair of end caps with screws.

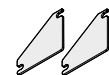

0,01

**XM2045-CUT**

Taglio lineare per moduli dritti.  
Linear cut for straight modules.

**L'Ufficio Tecnico Panzeri è disponibile a supporto della progettazione / Panzeri Technical Department is available to support the design**

**XM2045-U**

Giunzione lineare  
Linear junction

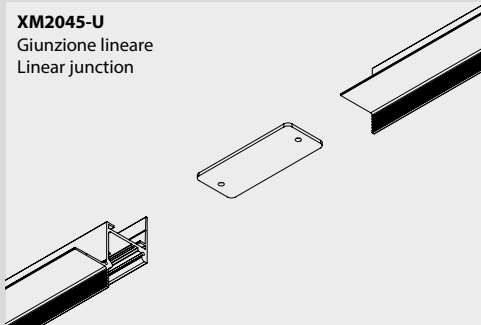
**XM2045-U90 1**

Angolo 1 piano 90° parete-parete / soffitto-soffitto misure esterne 64x64mm  
Angle 1 horizontal 90° wall-wall / ceiling-ceiling, external measurements 64x64mm

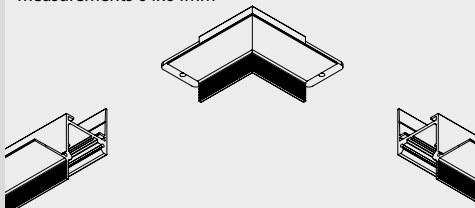
**XM2045-U90 2**

Angolo 2 piano 90° parete-parete / soffitto-soffitto misure esterne 64x64mm  
Angle 2 horizontal 90° wall-wall / ceiling-ceiling, external measurements 64x64mm

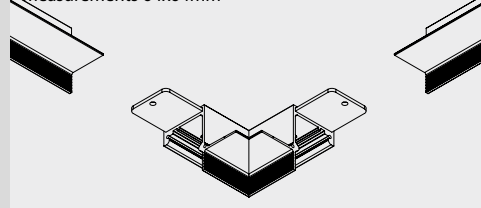
**XM2045-ANG 3**

Angolo 3 verticale 90° parete-soffitto/parete-parete misure esterne 64x64mm  
Angle 3 vertical 90° wall-ceiling / wall-wall, external measurements 64x64mm

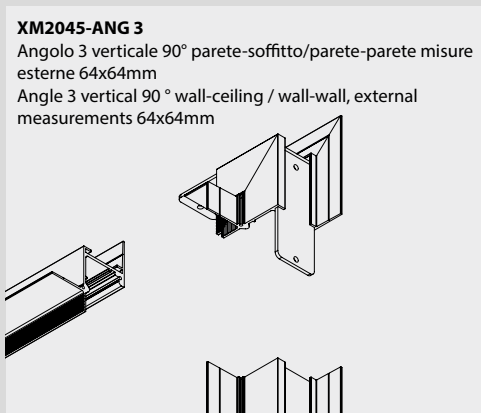
**XM2045-ANG 4**

Angolo 4 orizzontale 90° parete-parete misure esterne 64x64mm  
Angle 4 horizontal 90° wall-wall, external measurements 64x64mm

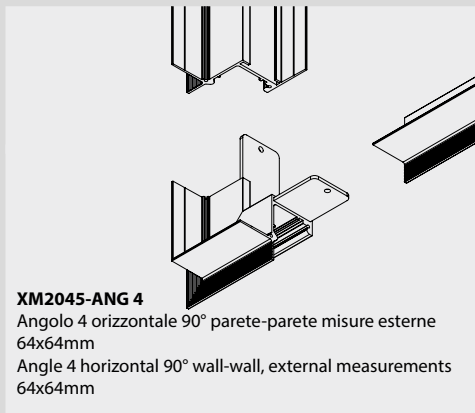





# GIANO XP246

XP246\_\_+LED+FEEDING KIT +XM246-\_\_T



Sistema modulare in alluminio estruso disponibile in versione sospensione o parete. Sorgente luminosa composta da modulo LED a luce diretta e indiretta e driver ON-OFF con accensione separata o DALI/Push DIM da integrare all'interno del profilo. Finitura con vernice poliaccrilica in bianco o nero e finitura frontale del profilo liscia. Schermo in policarbonato estruso opale o microprismatico. Ideale per uffici, corridoi, scale.

Modular extruded aluminum wall and suspension system. Light source made of LED module with direct and indirect light and separate switching ON-OFF or DALI/Push DIM drivers to be integrated into the profile. Finish in polyacrylic paint in white or black and smooth front finish of the profile. Diffuser in opal or micro prismatic polycarbonate. Ideal for offices, corridors, stairways.

Electric options page 188

Technical information 193

Wiring diagram 1 193

UGR <19 depending on installation conditions

Photometric data available at [www.panzeri.it](http://www.panzeri.it)

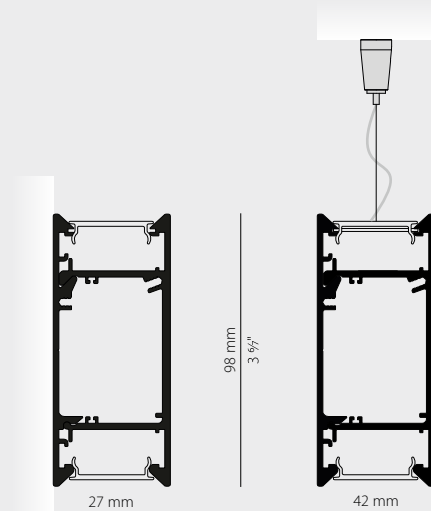

## WALL SUSPENSION

IP40 850°

	CODICE / CODE	L MM	L INCHES	kg
Fornito completo di n.2 schermi diffusori opalini	<b>XP24646.050.0099</b>	515	20 3/4"	1,19
Supplied with n.2 opal diffuser	<b>XP24648.050.0099</b>	515	20 3/4"	1,19
	<b>XP24646.100.0099</b>	1015	40"	2,38
	<b>XP24648.100.0099</b>	1015	40"	2,38
	<b>XP24646.200.0099</b>	2015	79 3/8"	4,76
	<b>XP24648.200.0099</b>	2015	79 3/8"	4,76
	<b>XP24646.300.0099</b>	3015	118 4/8"	7,14
	<b>XP24648.300.0099</b>	3015	118 4/8"	7,14

## LED MODULE



	CODICE / CODE	L MM	L INCHES	MM	INCHES	W	W/M	LM	LM/M	NR. LED	LED	V
	<b>XM006.050.0410</b>	500	19 3/8"	62,5	2 1/2"	8,6W	17,2W/m	1140lm	2280lm/m	64	3000K Ra>90	24V DC
	<b>XM006.012.0410</b>	125	5"	62,5	2 1/2"	2,15W	17,2W/m	258lm	2280lm/m	16	3000K Ra>90	24V DC
	<b>YLR005.010.0410</b>	5000	197"	50	2"		9,6W/m		1220lm/m	200/m	3000K Ra>80	24V DC
	<b>YLR006.017.0410</b>	5000	197"	42	1 3/8"		16,8W/m		2070lm/m	200/m	3000K Ra>90	24V DC

**Altre temperature di colore disponibili a pag. 188 / Other colour temperatures available on page 188**

Matrice di compatibilità LED / Profili pag. 139 / LED Profile Matrix page 139

## CODICI COLORI DISPONIBILI / COLOUR CODES AVAILABLE

<b>46</b> bianco/schermo opalino white/opal screen	<b>48</b> nero/schermo opalino black/opal screen	<b>01</b> bianco white	<b>02</b> nero black
---	---	---------------------------	-------------------------

## ACCESSORI / ACCESSORIES

	kg
<b>XM246-U</b> Kit di giunzione lineare. Linear junction kit.	0,04
<b>XM246-01T</b> <b>XM246-02T</b> Coppia di testate di chiusura. Pair of end caps.	0,03
<b>XM246-01-KIT-S</b> <b>XM246-02-KIT-S</b> Coppia di kit di sospensione, con fune di acciaio di lunghezza 2000mm (78 4/5"). Pair of suspension kits, with 2000mm (78 4/5") long steel wire..	0,12
<b>XM246-01-KIT-S1</b> <b>XM246-02-KIT-S1</b> Kit di sospensione singolo per giunzioni, con fune di acciaio di lunghezza 2000mm (78 4/5"). Single suspension kit for junctions, with 2000mm (78 4/5") long steel wire..	0,06
<b>XM30/24I</b> Alimentatore LED, 30W 24V DC. LED driver, 30W 24V DC.	0,04
<b>XM60/24I</b> Alimentatore LED, 75W 24V DC. LED driver, 75W 24V DC.	0,30
<b>XM120/24I</b> Alimentatore LED, 120W 24V DC. LED driver, 120W 24V DC.	0,28
<b>XM35/24I DIM</b> Alimentatore LED, 35W 24V DC, dimmerabile DALI/Push DIM. LED driver, 35W 24V DC, DALI/Push DIM dimmable.	0,15
<b>XM60/24I DIM</b> Alimentatore LED, 60W 24V DC, dimmerabile DALI/Push DIM. LED driver, 60W 24V DC, DALI/Push DIM dimmable.	0,18
<b>XM100/24I DIM</b> Alimentatore LED, 100W 24V DC, dimmerabile DALI/Push DIM. LED driver, 100W 24V DC, DALI/Push DIM dimmable.	0,27
<b>XM150/24I DIM</b> Alimentatore LED, 150W 24V DC, dimmerabile DALI/Push DIM. LED driver, 150W 24V DC, DALI/Push DIM dimmable.	0,29
<b>XM2038/46-3</b> Kit di alimentazione con rosone bianco, cavo di alimentazione a 3 poli di lunghezza 2,2m (86,6"). Power supply kit with white canopy, 3 pole power cable with lenght 2,2m (86,6").	0,45
<b>XM2038/46-5</b> Kit di alimentazione con rosone bianco, cavo di alimentazione a 5 poli di lunghezza 2,2m (86,6"). Power supply kit with white canopy, 5 pole power cable with lenght 2,2m (86,6").	0,56
<b>XM246-ALU CUT</b> Taglio a richiesta di estruso di alluminio. Extruded aluminum cut on request.	

**XM246-SCREEN CUT**

Taglio a richiesta di schermo in policarbonato.  
Polycarbonate screen cut on request.

**DRIVER MATRIX XP246**

CODE	KIT ALIMENTAZIONE INTERNA POWER SUPPLY KIT	KIT ALIMENTAZIONE DALI / PUSH DIM INTERNA DALI / PUSH DIM POWER SUPPLY KIT
<b>XP246__050.0099</b>	1x XM30/24I	1x XM35/24I DIM
<b>XP246__100.0099</b>	1x XM60/24I	1x XM60/24I DIM
<b>XP246__200.0099</b>	1x XM120/24I	1x XM100/24I DIM
<b>XP246__300.0099</b>	1x XM120/24I	1x XM150/24I DIM

**DIFFUSERS**

CODICE / CODE	L MM	L INCHES		kg
<b>XM2033/34/45/46-600S</b>	6000 x 30	236 <sup>3</sup> / <sub>8</sub> " x 1 <sup>1</sup> / <sub>8</sub> "	Schermo diffusore in policarbonato estruso con finitura opalina, di lunghezza 6000mm (236,2"). Extruded polycarbonate diffuser with opaline finish, 6000mm (236,2") long.	0,47
<b>XM2033/34/45/46-900S</b>	9000 x 30	354 <sup>3</sup> / <sub>8</sub> " x 1 <sup>1</sup> / <sub>8</sub> "	Schermo diffusore in policarbonato estruso con finitura opalina, di lunghezza 9000mm (354,3"). Extruded polycarbonate diffuser with opaline finish, 9000mm (354,3") long.	0,69
<b>XM2033/34/45/46-1200S</b>	12000 x 30	472 <sup>4</sup> / <sub>8</sub> " x 1 <sup>1</sup> / <sub>8</sub> "	Schermo diffusore in policarbonato estruso con finitura opalina, di lunghezza 12000mm (472,4"). Extruded polycarbonate diffuser with opaline finish, 12000mm (472,4") long.	0,93
<b>XM2033/34/45/46-600S PR</b>	6000 x 30	236 <sup>3</sup> / <sub>8</sub> " x 1 <sup>1</sup> / <sub>8</sub> "	Schermo diffusore in policarbonato estruso microprismatico, di lunghezza 6000mm (236,2"). Micro-prismatic extruded polycarbonate diffuser, 6000mm (236,2") long.	0,47
<b>XM2033/34/45/46-900S PR</b>	9000 x 30	354 <sup>3</sup> / <sub>8</sub> " x 1 <sup>1</sup> / <sub>8</sub> "	Schermo diffusore in policarbonato estruso microprismatico, di lunghezza 9000mm (354,3"). Micro-prismatic extruded polycarbonate diffuser, 9000mm (354,3") long.	0,69
<b>XM2033/34/45/46-1200S PR</b>	12000 x 30	472 <sup>4</sup> / <sub>8</sub> " x 1 <sup>1</sup> / <sub>8</sub> "	Schermo diffusore in policarbonato estruso microprismatico, di lunghezza 12000mm (472,4"). Micro-prismatic extruded polycarbonate diffuser, 12000mm (472,4") long.	0,93

**L'Ufficio Tecnico Panzeri è disponibile a supporto della progettazione / Panzeri Technical Department is available to support the design**



# HARLEM XG251

Enzo Panzeri 2022

Patent pending

XG251\_+\_LED+YTC25101.K02

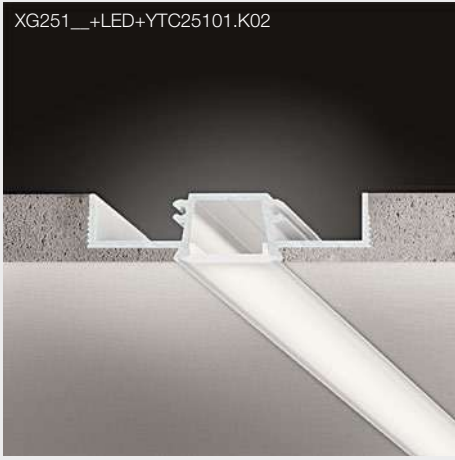

Sistema modulare di profili in alluminio estruso verniciato bianco, studiati per l'incasso in pannelli di cartongesso con effetto di scomparsa totale. La forma è pensata per non interferire con i telai di sostegno dei pannelli, garantendo la possibilità di posa in fila continua in qualunque punto della struttura. Le superfici forate su cui applicare il materiale per la rasatura assicurano una tenuta del gesso nel tempo; il risultato ottimale delle operazioni di rasatura, stuccatura e verniciatura è agevolato anche dalla presenza dello schermo monouso fornito di serie. Ogni modulo è completo di diffusore in policarbonato opalino.

Modular system of profiles in extruded aluminum in white finish, conceived for total recessed installation in drywall. The design allow not to interfere with the support frames of drywall panels, and grant free installation wherever required. The perforated surface of the profile enhances a durable application of plaster over time; moreover the disposable screen for installation ensures an optimal result in plastering and finishing the wall or ceiling. Supplied with additional opal polycarbonate diffuser.

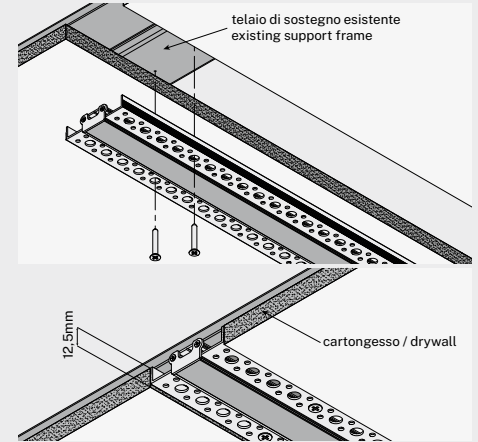
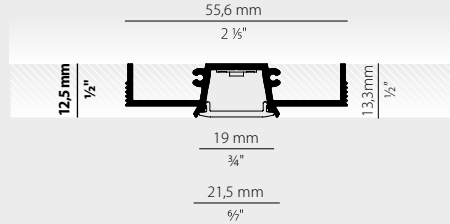

Electric options	page 188
Technical information	193
Wiring diagram 1	193
UGR <19 depending on installation conditions	
Photometric data available at <a href="http://www.panzeri.it">www.panzeri.it</a>	

## TRIMLESS PROFILE

	CODICE / CODE	L MM	L INCHES	MM	INCHES	kg
Fornito completo di schermo monouso e schermo diffusore opalino	<b>XG25101.100.0099</b>	1010	39 1/8"	1015 x 55	40" x 2 1/8"	
Supplied with disposable screen and opal diffuser	<b>XG25101.200.0099</b>	2010	79 1/8"	2015 x 55	79 3/8" x 2 1/8"	
	<b>XG25101.300.0099</b>	3010	118 3/8"	3015 x 55	118 4/8" x 2 1/8"	

## LED MODULE

	CODICE / CODE	L MM	L INCHES	MM	INCHES	W/M	LM/M	NR. LED	LED	V
	<b>YLR005.010.0410</b>	5000	197"	42	1 7/8"	9,6W/m	1220lm/m	200/m	3000K Ra>90	24V DC
	<b>YLR006.017.0410</b>	5000	197"	42	1 7/8"	16,8W/m	2070lm/m	200/m	3000K Ra>90	24V DC

Altre temperature di colore disponibili a pag. 188 / Other colour temperatures available on page 188

Matrice di compatibilità LED / Profili pag. 139 / LED Profile Matrix page 139

## CODICI COLORI DISPONIBILI / COLOUR CODES AVAILABLE

01 bianco  
white

## ACCESSORI / ACCESSORIES

### YTC25101.K02

Coppia di testate di chiusura con viti.  
Pair of end caps with screws.

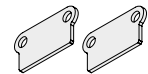

### XM27000.301.0099

Kit di giunzione lineare.  
Linear junction kit.

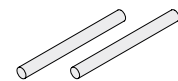

L'Ufficio Tecnico Panzeri è disponibile a supporto della progettazione / Panzeri Technical Department is available to support the design



# KIPS ROUND XG271-XG272-XG273

XG271/272/273\_+LED+XM27001.202.0099

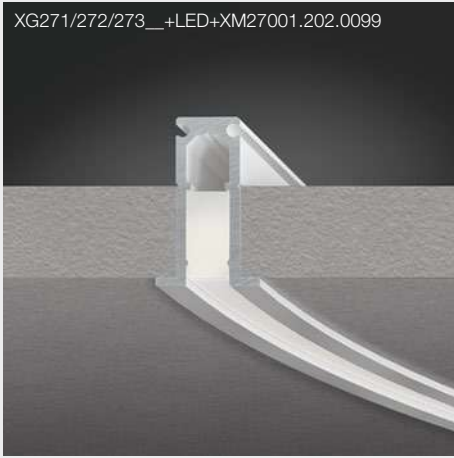

Profilo in alluminio estruso ad incasso di piccole dimensioni, strip LED con guaina in silicone bianco opale da acquistare separatamente. Studiato per consentire l'installazione su pannelli in cartongesso a soffitto o parete. Disponibili moduli lineari e curvi, con molteplici possibilità di combinazione.

Small extruded aluminum profile recessed, with LED strip with opal white silicone sheath to order separately. Designed to allow installation on ceiling or wall plasterboard panels. Linear and curved modules are available with multiple combination possibilities.

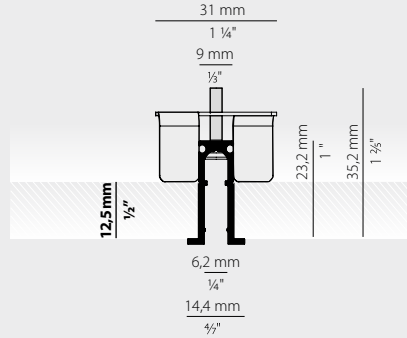

Electric options only with remote components	page 191
Dimming / Power supply	191-192
Technical information	193
Wiring diagram 2	193
Photometric data available at <a href="http://www.panzeri.it">www.panzeri.it</a>	

## TRIM PROFILE



LED IP40 IP20 850°

CODICE / CODE	DEGREES	Ø MM	Ø INCHES	H MM	H INCHES	NR. ADVISED	MM	INCHES	kg
<input type="radio"/> XG27101.100.0099	45°	1033	40 5/8"	23,2	1"	2	Ø ext. 1029 / int. 1008	Ø ext. 40 1/2" / int. 39 5/8"	0,09
<input type="radio"/> XG27201.100.0099	90°	1033	40 5/8"	23,2	1"	2	Ø ext. 1029 / int. 1008	Ø ext. 40 1/2" / int. 39 5/8"	0,18
<input type="radio"/> XG27301.100.0099	180°	1033	40 5/8"	23,2	1"	3	Ø ext. 1029 / int. 1008	Ø ext. 40 1/2" / int. 39 5/8"	0,36

## LED MODULE



CODICE / CODE	L MM	L INCHES	MM	INCHES	W	LM	LM/M	LED	V
 YLR101.011.0110	1000	39 3/8"	50	2"	10,6W	401lm	401lm/m	3000K Ra>80	24V DC
YLR102.011.0110	5000	197"	50	2"	10,6W/m	2005lm	401lm/m	3000K Ra>80	24V DC

Matrice di compatibilità LED / Profili pag. 139 / LED Profile Matrix page 139

## CODICI COLORI DISPONIBILI / COLOUR CODES AVAILABLE

01 bianco  
white

### Esempio di composizione / Example of configuration:

- N.3 Kips Round XG27201.100.0099
- N.4 Kips XG27001.050.0099
- N.14 wing nut XM2701.201.0099
- N.6 kit linear junction XM27000.301.0099
- N.1 kit faston XM27000.401.0099
- N.2 strip LED YLR102.011.0110
- N.1 driver YDV.024.120.A01





# KIPS XG270

XG270\_+LED+XM27001.202.0099



Profilo in alluminio estruso ad incasso di piccole dimensioni, strip LED con guaina in silicone bianco opale da acquistare separatamente. Studiato per consentire l'installazione su pannelli in cartongesso a soffitto o parete. Disponibili moduli lineari e curvi, con molteplici possibilità di combinazione.

Small extruded aluminum profile recessed, with LED strip with opal white silicone sheath to order separately. Designed to allow installation on ceiling or wall plasterboard panels. Linear and curved modules are available with multiple combination possibilities.

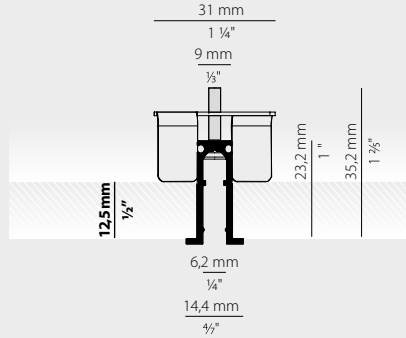

Electric options only with remote components	page 191
Dimming / Power supply	191-192
Technical information	193
Wiring diagram 2	193
Photometric data available at <a href="http://www.panzeri.it">www.panzeri.it</a>	

## TRIM PROFILE

CODICE / CODE	L MM	L INCHES	NR. ADVISED	MM	INCHES	kg
<b>XG27001.050.0099</b>	500	19 3/8"	2	505 x 11	19 8/8" x 3/8"	0,11
<b>XG27001.100.0099</b>	1000	39 3/8"	2	1005 x 11	39 3/8" x 3/8"	0,23
<b>XG27001.200.0099</b>	2000	78 4/8"	3	2005 x 11	79" x 3/8"	0,45
<b>XG27001.300.0099</b>	3000	118 1/8"	4	3005 x 11	118 2/8" x 3/8"	0,68

## LED MODULE

CODICE / CODE	L MM	L INCHES	MM	INCHES	W	LM	LM/M	LED	V
<b>YLR101.011.0110</b>	1000	39 3/8"	50	2"	10,6W	401lm	401lm/m	3000K Ra>80	24V DC
<b>YLR102.011.0110</b>	5000	197"	50	2"	10,6W/m	2005lm	401lm/m	3000K Ra>80	24V DC

Matrice di compatibilità LED / Profili pag. 139 / LED Profile Matrix page 139

## CODICI COLORI DISPONIBILI / COLOUR CODES AVAILABLE

01 bianco  
white

## ACCESSORI / ACCESSORIES

### XM27000.201.0099

Farfalla di fissaggio su cartongesso.  
Drywall fixing bracket.

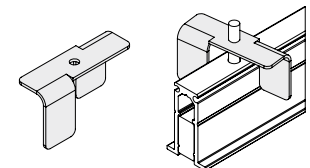

### XM27001.202.0099

Coppia di testate di chiusura con viti.  
Pair of end caps with screws.

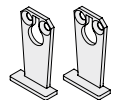

### XM27000.301.0099

Kit di giunzione lineare.  
Linear junction kit.

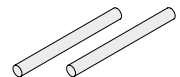

### XM27000.401.0099

Kit di faston per il collegamento elettrico (10 pezzi).  
Faston kit for electrical connection (10 pieces).

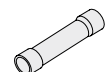



# MANHATTAN XG2044

XG2044-\_\_TRACK+LED+XM2044-T



Sistema modulare LED in alluminio estruso verniciato bianco, da incasso a scomparsa totale (trimless) per applicazioni in cartongesso. Oltre alla possibilità di installazione a parete e soffitto, in posizione orizzontale e verticale, si presta in modo particolare per installazioni perimetrali. Grazie alla riflessione della luce interna, il profilo non necessita di un diffusore.

Trimless modular LED system in extruded aluminum painted white for use in false ceiling. Besides the possibility of horizontal or vertical installation on walls and ceilings, this system is particularly suitable for perimeter installation. Due to the reflection of the internal light, this profile does not require a diffuser.

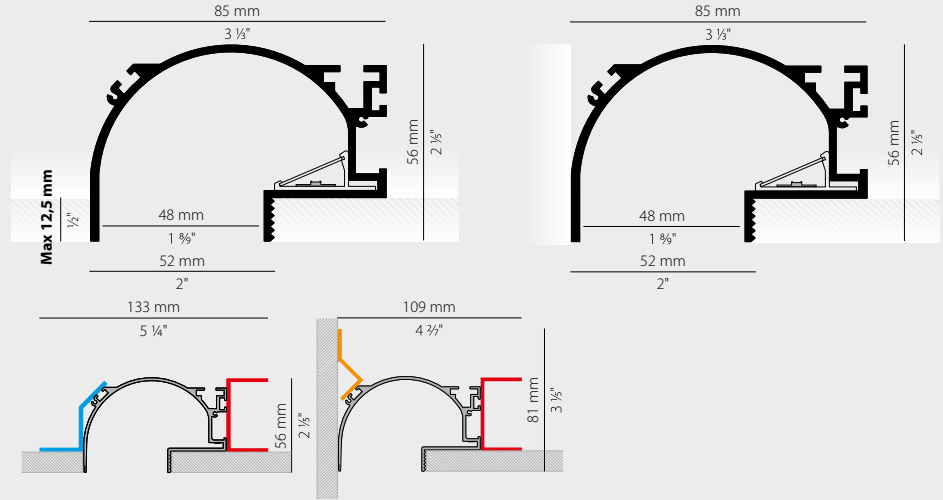

Electric options only with remote components	page 188
Dimming / Power supply	191-192
Technical information	193
Wiring diagram 2-3	193-194
UGR <19 depending on installation conditions	
Photometric data available at <a href="http://www.panzeri.it">www.panzeri.it</a>	

## TRIMLESS PROFILE

Fornito completo di supporto in alluminio per LED e schermo diffusore  
Supplied with aluminium LED frame and diffuser

CODICE / CODE	L MM	L INCHES	NR. ADVISED	MM	INCHES	kg
<b>XG2044-50TRACK</b>	420	16 5/8"	2	425 x 58	16 3/4" x 2 3/8"	0,69
<b>XG2044-100TRACK</b>	920	36 1/4"	2	925 x 58	36 5/8" x 2 3/8"	1,38
<b>XG2044-200TRACK</b>	1920	75 3/8"	3	1925 x 58	75 5/8" x 2 3/8"	2,64
<b>XG2044-300TRACK</b>	2920	115"	4	2925 x 58	115 1/4" x 2 3/8"	4,13

## LED MODULE



CODICE / CODE	L MM	L INCHES	MM	INCHES	W/M	LM/M	NR. LED	LED	V
<b>YLR005.010.0410</b>	5000	197"	50	2"	9,6W/m	1220lm/m	200/m	3000K Ra>80	24V DC
<b>YLR006.017.0410</b>	5000	197"	42	1 3/8"	16,8W/m	2070lm/m	200/m	3000K Ra>90	24V DC
<b>YLR007.022.0410</b>	5000	197"	42	1 3/8"	22W/m	2700lm/m	240/m	3000K Ra>90	24V DC

**Altre temperature di colore disponibili a pag. 188 / Other colour temperatures available on page 188**

**Matrice di compatibilità LED / Profili pag. 139 / LED Profile Matrix page 139**

**Eventuali tagli e saldature su rollina sono da quantificare a progetto.  
Required cutting and welding on roll are to be calculated for each project.**

## CODICI COLORI DISPONIBILI / COLOUR CODES AVAILABLE

**01** bianco  
white

**21** foglia oro (a richiesta)  
gold leaf (available on request)

**23** foglia argento (a richiesta)  
silver leaf (available on request)

**24** foglia rame (a richiesta)  
copper leaf (available on request)

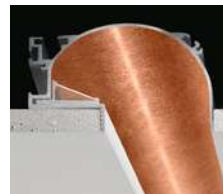

## ACCESSORI / ACCESSORIES

**XM2044-U90 1**

Elemento di collegamento per due linee di profili componibili con angolo di giunzione piano esterno di 90°, per installazione incassata a scomparsa.  
Connection joint for two lines of modular profiles with external level junction 90°, for total built-in installation.

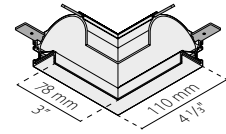
kg  
0,31**XM2044-U90 2**

Elemento di collegamento per due linee di profili componibili con angolo di giunzione piano interno di 90°, per installazione incassata a scomparsa.  
Connection joint for two lines of modular profiles with internal level junction 90°, for total built-in installation.

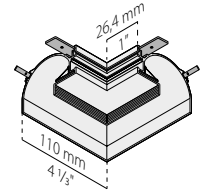

0,27

**XM2044-ANG 3**

Elemento di collegamento per due linee di profili componibili con angolo di giunzione perpendicolare interno di 90°, per installazione incassata a scomparsa.  
Connection joint for two lines of modular profiles with internal perpendicular junction 90°, for total built-in installation.

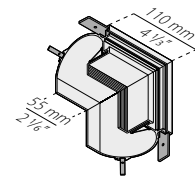

0,35

**XM2044-ANG 4**

Elemento di collegamento per due linee di profili componibili con angolo di giunzione perpendicolare esterno di 90°, per installazione incassata a scomparsa.  
Connection joint for two lines of modular profiles with external perpendicular junction 90°, for total built-in installation.

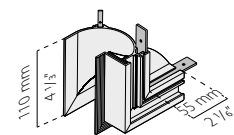

0,31

**XM2044-U**

Kit di giunzione lineare.  
Linear junction kit.

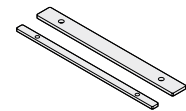

0,45

**XM2044-TA**

Vano per alimentazione con viti da fissare sulle giunzioni.  
Power compartment with screws for installation on junctions.

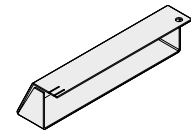

0,11

**XM2044-T**

Coppia di testate di chiusura con viti.  
Pair of end caps with screws.

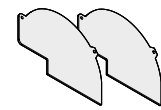

0,03

**XM2044-F**

Kit di staffe di fissaggio su cartongesso.  
Drywall fixing bracket kit.



0,06

**XM2044-FP**

Kit di staffe di fissaggio filo parete.  
Flush wall fixing bracket kit.

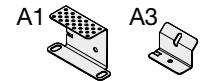

0,05

**XM2044-P**

Piastrina per appendimento.  
Plate for hanging.

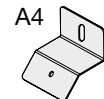

0,02

**XM2044-CUT**

Taglio lineare per moduli dritti.  
Linear cut for straight modules.

In considerazione della particolare forma del prodotto e delle eventuali sfumature di colore lungo e tra gli elementi del sistema XG2044, si evidenzia che è cura dell'installatore abbinare i pezzi adiacenti in modo da ottenere più uniformità possibile di colore. Nessuna responsabilità è imputabile al produttore.

Given the particular shape of the product and the eventual colour shades along and between the elements of system XG2044, please note that the installer has the responsibility to match the adjacent pieces so as to obtain the best colour uniformity. The manufacturer does not accept any liability.

L'Ufficio Tecnico Panzeri è disponibile a supporto della progettazione / Panzeri Technical Department is available to support the design



**XM2044-U**  
Giunzione lineare  
Linear junction

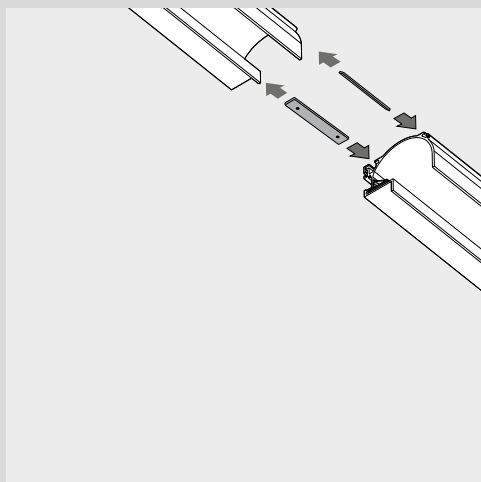

**XM2044-U90 1**  
Angolo 1 piano 90° parete-parete / soffitto-soffitto misure esterne 110x110mm  
Angle 1 horizontal 90° wall-wall / ceiling-ceiling, external measurements 110x110mm

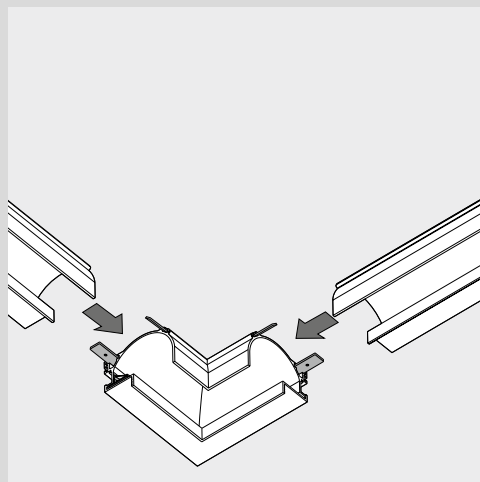

**XM2044-U90 2**  
Angolo 2 piano 90° parete-parete / soffitto-soffitto misure esterne 110x110mm  
Angle 2 horizontal 90° wall-wall / ceiling-ceiling, external measurements 110x110mm

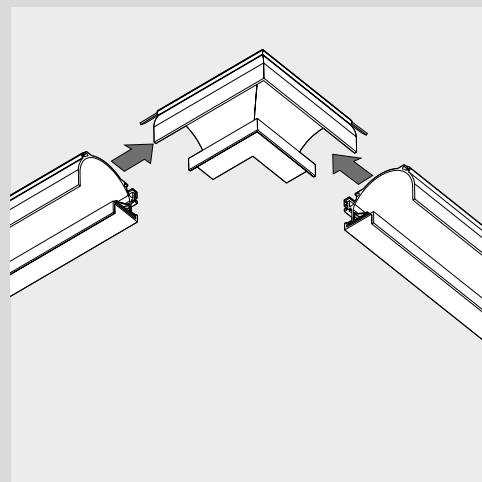

**XM2044-ANG 3**  
Angolo 3 verticale 90° parete-soffitto/parete-parete misure esterne 110x110mm  
Angle 3 vertical 90° wall-ceiling / wall-wall, external measurements 110x110mm

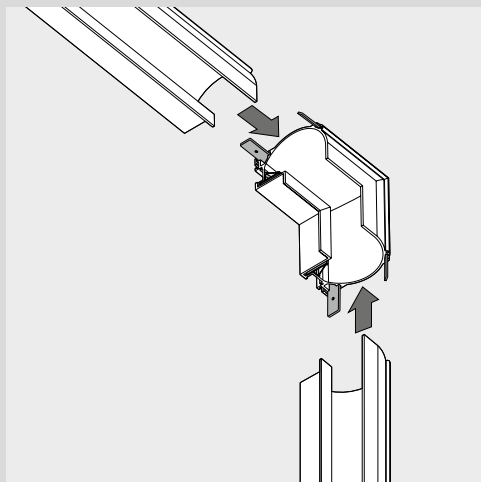

**XM2044-ANG 4**  
Angolo 4 orizzontale 90° parete-parete misure esterne 110x110mm  
Angle 4 horizontal 90° wall-wall, external measurements 110x110mm

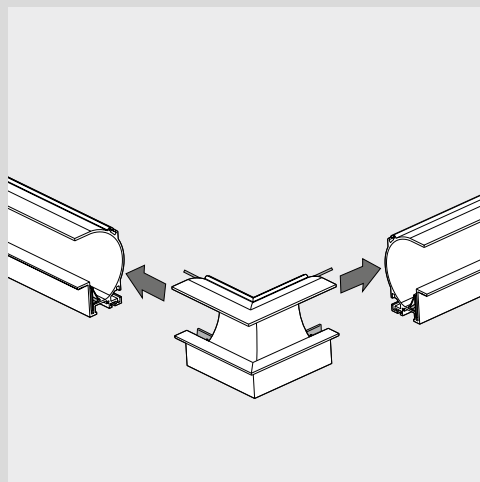

**XM2044-TA**  
Vano alimentazione (opzionale) con viti da fissare sulla giunzione  
Power compartment (optional) with screws for installation on the junction

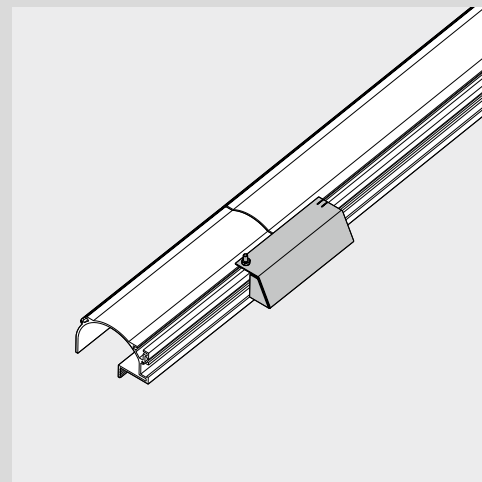

**ESEMPI DI INSTALLAZIONE / INSTALLATION EXAMPLE**

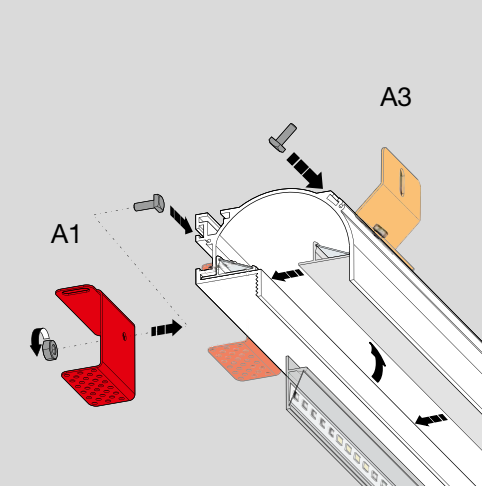
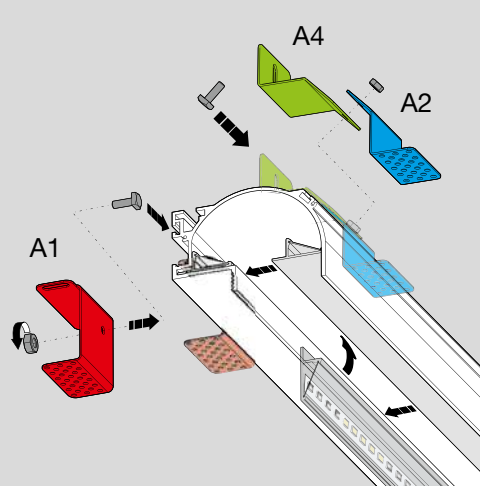
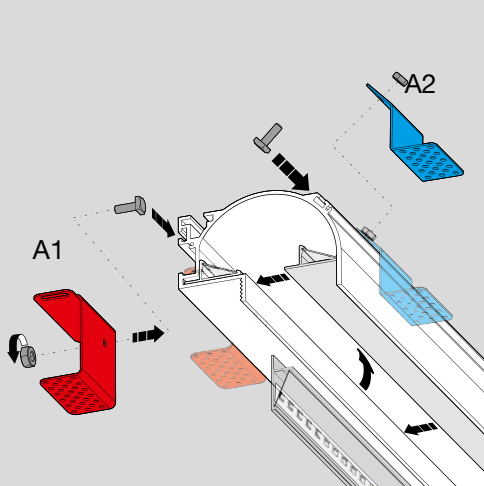



# BROADWAY XP248

XP248\_\_+LED+XM24801.202.0099



Profilo da parete/soffitto, sezionabile in alluminio estruso mm 2000 completo di diffusore in policarbonato.

Wall/ceiling cuttable profile in extruded aluminium supplied with polycarbonate diffuser.

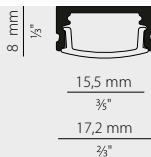

Electric options only with remote components	page 188
Dimming / Power supply	191-192
Technical information	193
Wiring diagram 2	193
Photometric data available at <a href="http://www.panzeri.it">www.panzeri.it</a>	

## CEILING / WALL PROFILE

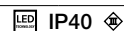

	CODICE / CODE	L MM	L INCHES	kg
Fornito completo di schermo diffusore Supplied with diffuser	<b>XP24801.200.0099</b>	2000	78 1/2"	0,27

## LED MODULE



	CODICE / CODE	L MM	L INCHES	MM	INCHES	W/M	LM/M	NR. LED	LED	V
	<b>YLR005.010.0410</b>	5000	197"	50	2"	9,6W/m	1220lm/m	200/m	3000K Ra>80	24V DC
	<b>YLR006.017.0410</b>	5000	197"	42	1 3/8"	16,8W/m	2070lm/m	200/m	3000K Ra>90	24V DC

Altre temperature di colore disponibili a pag. 188 / Other colour temperatures available on page 188

Matrice di compatibilità LED / Profili pag. 139 / LED Profile Matrix page 139

## CODICI COLORI DISPONIBILI / COLOUR CODES AVAILABLE

01 bianco  
white

## ACCESSORI / ACCESSORIES

### XM24801.202.0099

Coppia di testate di chiusura.  
Pair of end caps.

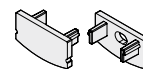

### XM24800.201.0099

Coppia di clip di fissaggio.  
Pair of fixing clips.

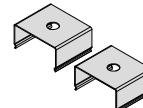



# NOOK XP250

XP250\_+LED+XM25001.202.0099



Profilo per installazione angolare, pensato per il montaggio in corrispondenza degli spigoli formati da due pareti o da parete e soffitto, oppure per applicazione sotto mensole e pensili. Modulo sezionabile, in alluminio estruso di lunghezza 2000mm completo di diffusore in policarbonato.

Profile for corner perimetral installation, designed to be installed at the edge of two walls or one wall and the ceiling, or alternatively as an application underneath shelves and cabinets. The profile can be cut on the project site, and is made of extruded aluminum 2000mm in length supplied with a opal polycarbonate diffuser.

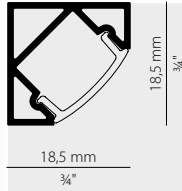

Electric options only with remote components	page 188
Dimming / Power supply	191-192
Technical information	193
Wiring diagram 2	193
Photometric data available at <a href="http://www.panzeri.it">www.panzeri.it</a>	

## CEILING /WALL PROFILE

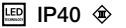

	CODICE / CODE	L MM	L INCHES	kg
Fornito completo di schermo diffusore Supplied with diffuser	<b>XP25001.200.0099</b>	2000	78 3/4"	

## LED MODULE



CODICE / CODE	L MM	L INCHES	MM	INCHES	W/M	LM/M	NR. LED	LED	V
<b>YLR005.010.0410</b>	5000	197"	50	2"	9,6W/m	1220lm/m	200/m	3000K Ra>80	24V DC
<b>YLR006.017.0410</b>	5000	197"	42	1 1/2"	16,8W/m	2070lm/m	200/m	3000K Ra>90	24V DC



**Altre temperature di colore disponibili a pag. 188 / Other colour temperatures available on page 188**

**Matrice di compatibilità LED / Profili pag. 139 / LED Profile Matrix page 139**

## CODICI COLORI DISPONIBILI / COLOUR CODES AVAILABLE

- 01** bianco  
white

## ACCESSORI / ACCESSORIES

kg

### XM25001.202.0099

Coppia di testate di chiusura.  
Pair of end caps.



### XM25000.201.0099

Coppia di clip di fissaggio.  
Pair of fixing clips.





# TRIBECA XG249

XP249\_+\_LED+XM24901.202.0099



Profilo con bordo (trim) in alluminio estruso sezionabile, 2000mm completo di diffusore in policarbonato, da incasso per applicazioni in verticale o orizzontale.

Cutttable profile with border (trim) in extruded aluminium 2000mm complete of polycarbonate diffuser, recessed for vertical or horizontal use.

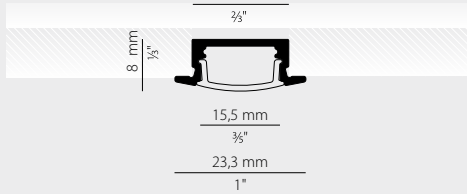

Electric options only with remote components	page 188
Dimming / Power supply	191-192
Technical information	193
Wiring diagram 2	193
Photometric data available at <a href="http://www.panzeri.it">www.panzeri.it</a>	

## TRIM PROFILE

	CODICE / CODE	L MM	L INCHES	MM	INCHES	kg
Fornito completo di schermo diffusore Supplied with diffuser	<b>XG24901.200.0099</b>	2000	78 1/2"	2000 x 17	78 1/2" x 3/8"	0,31

## LED MODULE

	CODICE / CODE	L MM	L INCHES	MM	INCHES	W/M	LM/M	NR. LED	LED	V
	<b>YLR005.010.0410</b>	5000	197"	50	2"	9,6W/m	1220lm/m	200/m	3000K Ra>80	24V DC
	<b>YLR006.017.0410</b>	5000	197"	42	1 3/4"	16,8W/m	2070lm/m	200/m	3000K Ra>90	24V DC

Altre temperature di colore disponibili a pag. 188 / Other colour temperatures available on page 188

Matrice di compatibilità LED / Profili pag. 139 / LED Profile Matrix page 139

## CODICI COLORI DISPONIBILI / COLOUR CODES AVAILABLE

01 bianco  
white

## ACCESSORI / ACCESSORIES

**XM24901.202.0099**  
Coppia di testate di chiusura.  
Pair of end caps.

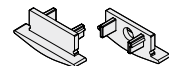

# VADEMECUM PROFILI / PROFILE HANDBOOK

GIUNZIONI DISPONIBILI / AVAILABLE JOINTS						
MODELLO / MODEL	GIUNZIONE / JOINT					
	LINEARE/LINEAR	90°	T	X	ANG. VERTICALI/VERTICAL ANGLE	SPECIALI / SPECIAL
XG2033	•	•	•	•	•	•
XP2033	•	•				
XG2034	•	•			•	
XG2044	•	•				
XG2045	•	•			•	
XP246	•					
XG247	•	•				
XP248	•					
XG249	•					
XP250	•					
XG251	•					
XG270	•					
XG271 / XG272 / XG273	•					

•\* Solo versione ON/OFF / ON/OFF version only

MATRICE LED/PROFILO / LED PROFILE MATRIX							
MODELLO / MODEL	XM006	YLR007	YLR006	YLR005	YLR008	YLR101	YLR102
XG2033	•	•	•	•	•		
XP2033	•	•	•	•	•		
XG2034	•	•	•	•	•		
XG2044		•	•	•	•		
XG2045	•	•	•	•	•		
XP246	•	•	•	•	•		
XG247							
XP248			•	•			
XG249			•	•			
XP250			•	•			
XG251			•	•			
XG270						•	•
XG271 / XG272 / XG273						•	•

INFORMAZIONI LED / LED SPECIFICATION					
MODELLO / MODEL	POTENZA (W/m) POWER (W/m)	FLUSSO LUMINOSO (lm/m) LUMINOUS FLUX (lm/m)	DIVISIBILE OGNI (mm) ✂ CUT EVERY (mm)	LED/m	LUNGHEZZA (mm) / LENGHT (mm)
XM006	17,2	2280	62,5	128	50% <sub>125</sub>
YLR005	9,6	1100 - 1220 - 1300	5	200	5000
YLR006	16,8	1900 - 2070 - 2220	5	200	5000
YLR007	22	2490 - 2700 - 2750	4,2	240	5000
YLR008	9,6	1100 - 1220	5	200	5000
YLR101	10,6	401	50		1000
YLR102	10,6	401	50		5000

DIMENSIONI E POSSIBILITÀ DI TAGLIO / DIMENSIONS AND CUT CONFIGURATION						
MODELLO / MODEL	DIMENSIONI STANDARD / STANDARD DIMENSIONS				TAGLIABILE / CUTTABLE	
XG2033	510	1010	2010	3010	•	
XP2033	525	1025	2025	3025	•	
XG2034	510	1010	2010	3010	•	
XG2044	420	920	1920	2920	•	
XG2045	510	1010	2010	3010	•	
XP246	515	1015	2015	3015	•	
XG247	510	1010	2010	3010	•	
XP248	2000				•	
XG249	2000				•	
XP250	2000				•	
XG251	1010	2010	3010		•	
XG270	500	1000	2000	3000	•	

## ANGOLI / ANGLE U90-1/U90-2

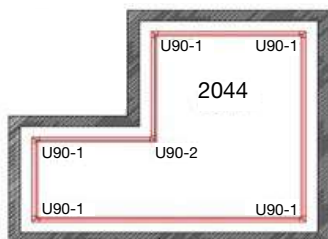

La luce nella configurazione standard è rivolta principalmente verso la parete

With standard configuration light is mainly oriented towards the wall

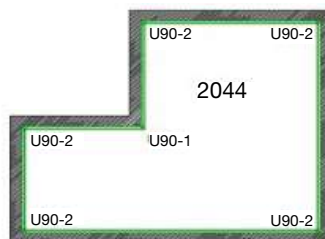

La luce nella configurazione standard è rivolta principalmente verso il centro della stanza

With standard configuration light is mainly oriented towards the center of room

## **PROIETTORI / SPOTLIGHT**

143	<b>ASTORIA 3</b>
142	<b>ASTORIA 5</b>
141	<b>ASTORIA 8</b>
146	<b>ASTORIA IN</b>
144	<b>ASTORIA LINE</b>
148	<b>ASTORIA OUT</b>
145	<b>ASTORIA SPOT</b>
155	<b>QUEENS</b>
154	<b>QUEENS 10</b>
153	<b>QUEENS 20</b>
152	<b>QUEENS 25</b>
151	<b>QUEENS 45</b>
162	<b>SOHO IN</b>
161	<b>SOHO LINE</b>
164	<b>SOHO OUT</b>
159	<b>SOHO 5</b>
158	<b>SOHO 10</b>
157	<b>SOHO 20</b>
160	<b>SOHO S 15</b>



# ASTORIA 8



Proiettore orientabile in pressofusione di alluminio con LED ad alta efficienza e adattatore integrato, per binario elettrificato a bassissima tensione 48V. Completo di cilindro antiabbagliamento e lente con fascio medio in materiale termoplastico. Disponibile in versione 2700K e 3000K, in finitura bianco, nero, ottone satinato e bronzo, con braccio e coperchio posteriore in colore nero.

Die-cast aluminium adjustable spotlight with high efficiency LED and integrated adapter for 48V low voltage electrified track. Complete with anti-glare snoot and thermoplastic medium-beam lens. Available in 2700K and 3000K version, in white, black, mat brass and bronze finishes, with black arm and back cover.

NEW	CODICE CODE	FONTI LUMINOSE LIGHT SOURCES	kg
	<b>B43401.008.1719</b>	Potenza assorbita apparecchio / Luminaire power consumption 15W	0,20
	<b>B43402.008.1719</b>	Flusso luminoso apparecchio / Luminaire luminous flux 1100lm	
	<b>B43417.008.1719</b>	2700K Ra>90 24° 48V DC dimmable (DALI)	
	<b>B43419.008.1719</b>	IP20	
	<b>B43401.008.2519</b>	Potenza assorbita apparecchio / Luminaire power consumption 15W	0,20
	<b>B43402.008.2519</b>	Flusso luminoso apparecchio / Luminaire luminous flux 1100lm	
	<b>B43417.008.2519</b>	3000K Ra>90 24° 48V DC dimmable (DALI)	
	<b>B43419.008.2519</b>	IP20	

	<b>STANDARD</b>	Lente per fascio medio. Flood lens.	
	<b>YLN43400.15</b>	Lente per fascio stretto. Spot lens.	0,01
	<b>YLN43400.35</b>	Lente per fascio medio. Flood lens.	0,01

Fotometrie disponibili [www.panzeri.it](http://www.panzeri.it) / Photometric data available at [www.panzeri.it](http://www.panzeri.it)

### CODICI COLORI DISPONIBILI / COLOUR CODES AVAILABLE

**01** bianco white      **02** nero black      **17** bronzo bronze      **19** ottone satinato mat brass





# ASTORIA 5



Proiettore orientabile in pressofusione di alluminio con LED ad alta efficienza e adattatore integrato, per binario elettrificato a bassissima tensione 48V. Completo di cilindro antiabbagliamento e lente con fascio medio in materiale termoplastico. Disponibile in versione 2700K e 3000K, in finitura bianco, nero, ottone satinato e bronzo, con braccio e coperchio posteriore in colore nero.

Die-cast aluminium adjustable spotlight with high efficiency LED and integrated adapter for 48V low voltage electrified track. Complete with anti-glare snoot and thermoplastic medium-beam lens. Available in 2700K and 3000K version, in white, black, mat brass and bronze finishes, with black arm and back cover.

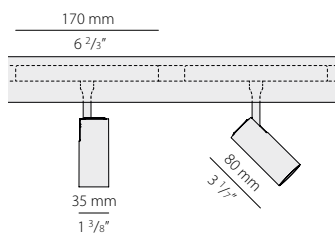

CODICE CODE	FONTI LUMINOSE LIGHT SOURCES	kg
<b>B43201.005.1719</b>	Potenza assorbita apparecchio / Luminaire power consumption 8,4W	0,13
<b>B43202.005.1719</b>	Flusso luminoso apparecchio / Luminaire luminous flux 590lm	
<b>B43217.005.1719</b>	2700K Ra>90 24° 48V DC dimmable (DALI)	
<b>B43219.005.1719</b>	IP20	
<b>B43201.005.2519</b>	Potenza assorbita apparecchio / Luminaire power consumption 8,4W	0,13
<b>B43202.005.2519</b>	Flusso luminoso apparecchio / Luminaire luminous flux 590lm	
<b>B43217.005.2519</b>	3000K Ra>90 24° 48V DC dimmable (DALI)	
<b>B43219.005.2519</b>	IP20	

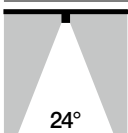

### STANDARD

Lente per fascio medio.  
Flood lens.

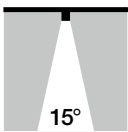

### YLN43200.15

Lente per fascio stretto.  
Spot lens.

0,01

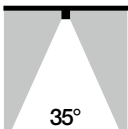

### YLN43200.35

Lente per fascio medio.  
Flood lens.

0,01

Fotometrie disponibili [www.panzeri.it](http://www.panzeri.it) / Photometric data available at [www.panzeri.it](http://www.panzeri.it)

### CODICI COLORI DISPONIBILI / COLOUR CODES AVAILABLE







# ASTORIA 3



Proiettore orientabile in pressofusione di alluminio con LED ad alta efficienza e adattatore integrato, per binario elettrificato a bassissima tensione 48V. Completo di cilindro antiabbagliamento e lente con fascio medio in materiale termoplastico. Disponibile in versione 2700K e 3000K, in finitura bianco, nero, ottone satinato, bronzo e titanio, con braccio e coperchio posteriore in colore nero.

Die-cast aluminium adjustable spotlight with high efficiency LED and integrated adapter for 48V low voltage electrified track. Complete with anti-glare snoot and thermoplastic medium-beam lens. Available in 2700K and 3000K version, in white, black, mat brass, bronze and titanium finishes, with black arm and back cover.

NEW	CODICE CODE	FONTI LUMINOSE LIGHT SOURCES	kg
	<b>B43301.003.1719</b>	Potenza assorbita apparecchio / Luminaire power consumption 7,2W	0,09
	<b>B43302.003.1719</b>	Flusso luminoso apparecchio / Luminaire luminous flux 447lm	
	<b>B43317.003.1719</b>	2700K Ra>90 24° 48V DC dimmable (DALI)	
	<b>B43319.003.1719</b>	IP20	
	<b>B43301.003.2519</b>	Potenza assorbita apparecchio / Luminaire power consumption 7,2W	0,09
	<b>B43302.003.2519</b>	Flusso luminoso apparecchio / Luminaire luminous flux 447lm	
	<b>B43317.003.2519</b>	3000K Ra>90 24° 48V DC dimmable (DALI)	
	<b>B43319.003.2519</b>	IP20	

	<b>STANDARD</b>	Lente per fascio medio. Flood lens.	
	<b>YLN43300.15</b>	Lente per fascio stretto. Spot lens.	0,01
	<b>YLN43300.35</b>	Lente per fascio medio. Flood lens.	0,01

Fotometrie disponibili [www.panzeri.it](http://www.panzeri.it) / Photometric data available at [www.panzeri.it](http://www.panzeri.it)

### CODICI COLORI DISPONIBILI / COLOUR CODES AVAILABLE





# ASTORIA LINE



Modulo lineare a luce diffusa per binario elettrificato a bassissima tensione 48V per applicazioni soffitto/ parete, sospensione e incasso, con corpo in alluminio in colore nero e schermo in policarbonato estruso opale. Possibilità di dimmerazione tramite protocollo DALI.

Linear LED module for 48V low voltage electrified track, for ceiling/wall, suspended or recessed applications. Black aluminium body, opal diffuser made in extruded polycarbonate. Possibility of dimming with DALI protocol.

	CODICE CODE	FONTI LUMINOSE LIGHT SOURCES	kg
	<b>B43102.060.0519</b>	Potenza assorbita apparecchio / Luminaire power consumption 11,4W Flusso luminoso apparecchio / Luminaire luminous flux 990lm 2700K Ra>90 48V DC dimmable (DALI) IP20	0,33
	<b>B43102.060.0419</b>	Potenza assorbita apparecchio / Luminaire power consumption 11,4W Flusso luminoso apparecchio / Luminaire luminous flux 990lm 3000K Ra>90 48V DC dimmable (DALI) IP20	0,33

Fotometrie disponibili [www.panzeri.it](http://www.panzeri.it) / Photometric data available at [www.panzeri.it](http://www.panzeri.it)

CODICI COLORI DISPONIBILI / COLOUR CODES AVAILABLE

**02** nero  
black





# ASTORIA SPOT

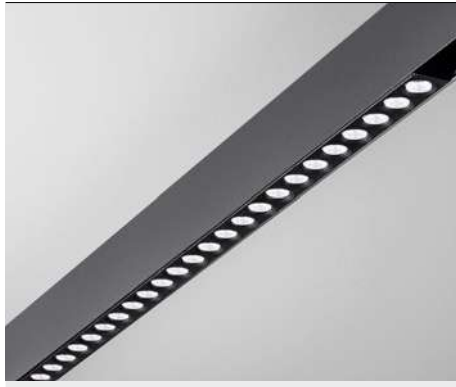

Modulo di luce lineare per binario elettrificato a bassissima tensione 48V per applicazioni soffitto/parete, sospensione e incasso, disponibile in due diverse lunghezze. Corpo in alluminio in colore nero, lenti con fascio 30° in policarbonato e copertura in materiale plastico. Possibilità di dimmerazione tramite protocollo DALI.

Linear LED module for 48V low voltage electrified track, for ceiling/wall, suspended or recessed applications, available in two different lengths. Black aluminium body, 30° beam polycarbonate lens and plastic cover. Possibility of dimming with DALI protocol.

	CODICE CODE	FONTI LUMINOSE LIGHT SOURCES	kg
	<b>B43002.030.1719</b>	Potenza assorbita apparecchio / Luminaire power consumption 5,7W Flusso luminoso apparecchio / Luminaire luminous flux 414lm 2700K Ra>90 30° 48V DC dimmable (DALI) IP20	0,22
	<b>B43002.030.2519</b>	Potenza assorbita apparecchio / Luminaire power consumption 5,7W Flusso luminoso apparecchio / Luminaire luminous flux 414lm 3000K Ra>90 30° 48V DC dimmable (DALI) IP20	0,22
	<b>B43002.060.1719</b>	Potenza assorbita apparecchio / Luminaire power consumption 10,6W Flusso luminoso apparecchio / Luminaire luminous flux 828lm 2700K Ra>90 30° 48V DC dimmable (DALI) IP20	0,37
	<b>B43002.060.2519</b>	Potenza assorbita apparecchio / Luminaire power consumption 10,6W Flusso luminoso apparecchio / Luminaire luminous flux 828lm 3000K Ra>90 30° 48V DC dimmable (DALI) IP20	0,37

Fotometrie disponibili [www.panzeri.it](http://www.panzeri.it) / Photometric data available at [www.panzeri.it](http://www.panzeri.it)

CODICI COLORI DISPONIBILI / COLOUR CODES AVAILABLE

**02** nero  
black

# ASTORIA IN



Sistema di binari a bassissima tensione 48V per applicazioni ad incasso. Binario a sezione rettangolare in alluminio estruso anodizzato nero, predisposto per alloggiare i proiettori e i moduli luminosi provvisti di adattatore 48V. Possibilità di regolazione DALI. Disponibile un'ampia varietà di accessori e giunti di collegamento.

System of 48V low voltage electrified tracks for recessed applications. Square-shaped track made of black anodised extruded aluminium, suitable to host spotlights and linear light modules equipped with 48V adapters. Possibility of DALI dimming. Wide range of available accessories and joints.

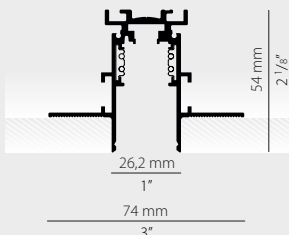

## TRIMLESS RECESSED ELECTRIFIED TRACK 48V DC

IP20 850°

CODICE / CODE	L MM	L INCHES	kg
9500-2/B-ST5-E	2000	78 7/8"	2,50

## CODICI COLORI DISPONIBILI / COLOUR CODES AVAILABLE

02 nero  
black

## ACCESSORI / ACCESSORIES

### S-9500-L/B-2000

Copertura di protezione per installazione binario elettrificato a incasso.  
Protective cover for recessed electrified track installation.

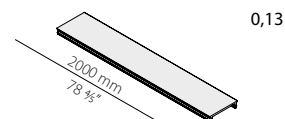

### S-9500/LE-B-3000

Copertura estetica per binario elettrificato 48V DC.  
Aesthetic cover for 48V DC electrified track.

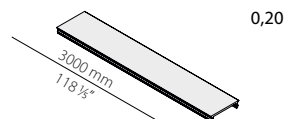

### 9501-S/B-E

Alimentazione di testa per binario elettrificato 48V DC DALI.  
Head power supply for 48V DC DALI electrified track.

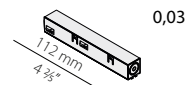

### S-9500/314-B

Giunzione lineare senza contatti per binario elettrificato a incasso 48V DC.

#### N. 3 PEZZI PER OGNI GIUNZIONE

Linear mechanical junction for recessed electrified 48V DC track.

#### 3 PIECES FOR EACH JUNCTION.

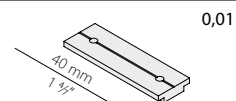

### 9503-S/B-E

Giunto lineare elettrificato per binario 48V DC DALI.  
Linear electrified joint for 48V DC DALI track.

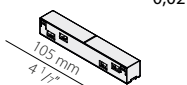

### S-9511/B-ST5

Giunzione meccanica a "L" per binario elettrificato 48V DC a incasso senza bordo.  
Mechanical "L" joint for 48V DC recessed trimless electrified track.

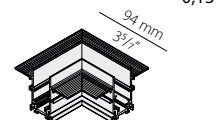

**9511/B-E**

Giunto elettrificato a "L" per binario 48V DC DALI.  
Electrified "L" joint for 48V DC DALI track.

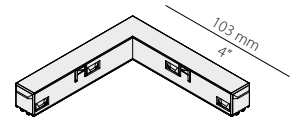

0,06

**S-9511-I/B-ST5**

Giunzione meccanica a "L" interna parete/soffitto per binario elettrificato 48V DC a incasso senza bordo.  
Internal wall/ceiling "L" joint for 48V DC recessed trimless electrified track.

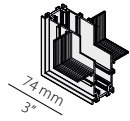

0,12

**9518-S/B-E**

Giunto elettrificato flessibile per binario 48V DC DALI.  
Flexible electrified joint for 48V DC DALI track.

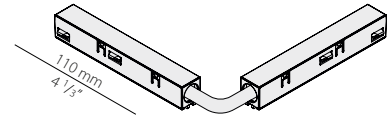

0,07

**9504/ST2-B**

Testata di chiusura per binario elettrificato 48V DC, senza foro.  
End cap for 48V DC electrified track, without power supply hole.



0,02

**9504/ST2-B-F**

Testata di chiusura per binario elettrificato 48V DC, con foro.  
End cap for 48V DC electrified track, with power supply hole.



0,02

**S-9000-P4**

Kit sospensione per binario ad incasso con tige rigida di lunghezza 1000mm (39,4").  
Suspension kit with rigid tige 1000mm (39,4") long for recessed track.

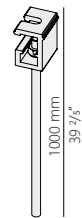

0,20

**S-9000/118**

Clip per fissaggio rapido con tenditore per tige rigida di sospensione.  
Clip for quick fastening with turnbuckle for rigid suspension tige.



0,01

**YBE41002.DV1**

Alimentatore integrato per binario elettrificato 48V DC, 100W, DALI.  
Integrated 100W power supply for electrified 48V DALI track.

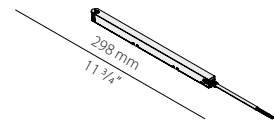

0,15

**YRS.B048.A16**

Dispositivo ripetitore per optoisolare il bus data, per binario elettrificato 48V DC DALI.

**ACCESSORIO OBBLIGATORIO**

Repeater device for opto-isolating the data bus, for 48V DC DALI electrified track.

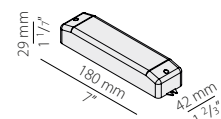
**MANDATORY ACCESSORY****YDV.048.075.A01**

Alimentatore LED, 75W 48V DC, on/off.  
LED driver, 75W 48V DC, on/off.

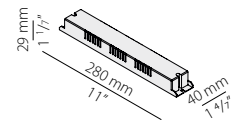

0,23

**YDV.048.150.A01**

Alimentatore LED, 150W 48V DC, on/off.  
LED driver, 150W 48V DC, on/off.

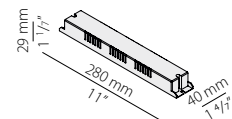

0,25

# ASTORIA OUT

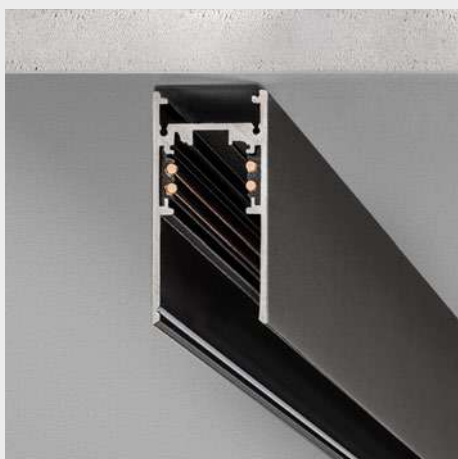

Sistema di binari a bassissima tensione 48V per installazioni a soffitto/parete o sospensione. Binario a sezione rettangolare in alluminio estruso anodizzato nero, predisposto per alloggiare i proiettori e i moduli luminosi provvisti di adattatore 48V. Parte esterna disponibile in finitura ottone e bronzo. Possibilità di regolazione DALI. Disponibile un'ampia varietà di accessori e giunti di collegamento.

System of 48V low voltage electrified tracks for ceiling/wall or suspended applications. Square-shaped track made of black anodised extruded aluminium, suitable to host spotlights and linear light modules equipped with 48V adapters. Outer part available in brass and bronze finish. Possibility of DALI dimming. Wide range of available accessories and joints.

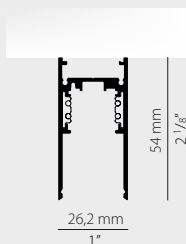

## ELECTRIFIED TRACK 48V DC

IP20 850°

CODICE / CODE	L MM	L INCHES	kg
<b>9500-2/B-ST2-E</b>	2000mm	78 4/5"	2,05

### CODICI COLORI DISPONIBILI / COLOUR CODES AVAILABLE

**02** nero  
black

## ELECTRIFIED TRACK 48V DC

IP20 850°

CODICE / CODE	L MM	L INCHES	kg
<b>NEW B41117.200</b>	2000mm	78 4/5"	2,05 <b>234,00</b>
<b>B41119.200</b>	2000mm	78 4/5"	<b>212,00</b>

### CODICI COLORI DISPONIBILI / COLOUR CODES AVAILABLE

**17** bronzo  
bronze

**19** ottone  
brass

## ACCESSORI / ACCESSORIES

### S-9500/LE-B-3000

Copertura estetica di lunghezza 3000mm (118,1") per binario elettrificato 48V DC.  
Aesthetic cover for 48V DC electrified track, length 3000mm (118.1")

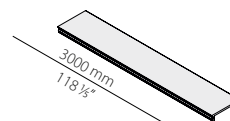

kg  
0,20

### 9501-S/B-E

Alimentazione di testa per binario elettrificato 48V DC DALI.  
Head power supply for 48V DC DALI electrified track.

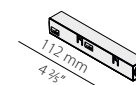

kg  
0,03

### S-9500/323-SV

Giunzione lineare per binario elettrificato a sospensione o plafone.  
Linear junction for suspended or ceiling-mounted electrified track.

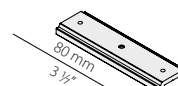

kg  
0,01

### 9503-S/B-E

Giunto lineare elettrificato per binario 48V DC DALI.  
Linear electrified joint for 48V DC DALI track.

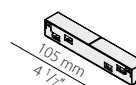

kg  
0,02

**S-9511/B-ST2**

Giunzione a "L" per binario elettrificato 48V DC a sospensione o plafone.  
"L" junction for 48V DC suspended or ceiling-mounted electrified track.

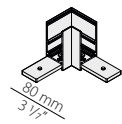

0,13

**9511/B-E**

Giunto elettrificato a "L" per binario 48V DC DALI.  
Electrified "L" joint for 48V DC DALI track.

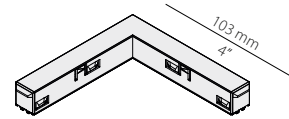

0,06

**9518-S/B-E**

Giunto elettrificato flessibile per binario 48V DC DALI.  
Flexible electrified joint for 48V DC DALI track.

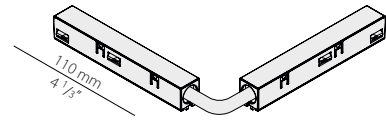

0,07

**9504/ST2-B**

Testata di chiusura per binario elettrificato 48V DC, senza foro.  
End cap for 48V DC electrified track, without power supply hole.



0,02

**9504/ST2-B-F**

Testata di chiusura per binario elettrificato 48V DC, con foro.  
End cap for 48V DC electrified track, with power supply hole.



0,02

**YBE41117.TC****YBE41119.TC**

Testata di chiusura per binario elettrificato 48V DC, senza foro, in finitura bronzo o ottone satinato.  
End cap for 48V DC electrified track, without power supply hole, in bronze or mat brass finish.

**NEW**

0,02

**YBE41117.TCF****YBE41119.TCF**

Testata di chiusura per binario elettrificato 48V DC, con foro, in finitura bronzo o ottone satinato.  
End cap for 48V DC electrified track, with power supply hole, in bronze or mat brass finish.

**NEW**

0,02

**S-9500/114-B**

Kit per attacco a soffitto per binario elettrificato 48V DC.  
Ceiling mounting kit for 48V DC electrified track.



0,01

**9500-KIT1-3**

Kit sospensione per estremità, con fune di acciaio di lunghezza 3000mm (118,1"), per binario elettrificato.  
End suspension kit, with 3000mm (118.1") long steel wire, for electrified track.

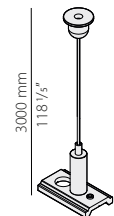

0,07

**9500-KIT2-3**

Kit fissaggio e giunzione per binario elettrificato a sospensione, con fune di acciaio di lunghezza 3000mm (118,1").  
Fixing and junction kit, with 3000mm (118.1") long steel wire, for suspended electrified track.

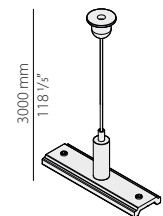

0,08

**9500/P-100E-B-SP-N**

Kit di alimentazione con rosone per binario elettrificato a sospensione, con driver 100W/48V e testata di alimentazione.  
Power supply kit with canopy for electrified suspended track, with 100W/48V driver and power supply head.

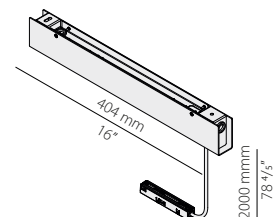

1,5

**9500/P-100E-B-C1-N**

Kit di alimentazione con rosone per binario elettrificato a plafone, con driver 100W/48V e testata di alimentazione.  
Power supply kit with canopy for ceiling-mounted electrified track, with 100W/48V driver and power supply head.

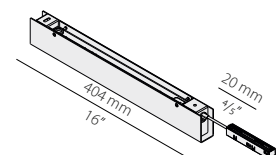

1,5

ACCESSORI / ACCESSORIES

kg

**YBE41002.DV1**

Alimentatore integrato per binario elettrificato 48V DC, 100W, DALI.  
Integrated 100W power supply for electrified 48V DALI track.

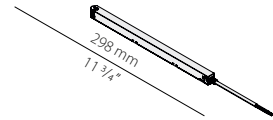

0,15

**YRS.B048.A16**

Dispositivo ripetitore per optoisolare il bus data, per binario elettrificato 48V DC DALI.

**ACCESSORIO OBBLIGATORIO**

Repeater device for opto-isolating the data bus, for 48V DC DALI electrified track.

**MANDATORY ACCESSORY**

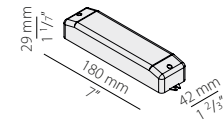

**YDV.048.075.A01**

Alimentatore LED, 75W 48V DC, on/off.  
LED driver, 75W 48V DC, on/off.

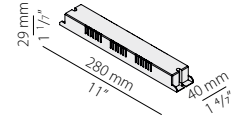

0,23

**YDV.048.150.A01**

Alimentatore LED, 150W 48V DC, on/off.  
LED driver, 150W 48V DC, on/off.

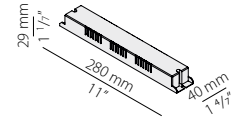

0,25







# QUEENS 45



Queens 45 è un proiettore dalle dimensioni compatte per binari elettrificati trifase, progettato per LED COB di ultima generazione. La disponibilità di differenti fasci luminosi e l'orientamento del corpo fino a 355° consentono molteplici soluzioni e regie luminose nel retail, spazi commerciali, musei ed aree espositive. Viene fornito completo di riflettore termoplastico metallizzato a specchio con ottica standard a fascio medio. Ottiche per fascio stretto o largo ordinabili su richiesta. Disponibile nella versione 3000K e nei colori bianco e nero.

Queens 45 is a compact projector for tri-phase electrified tracks, engineered with COB LEDs of latest generation. The availability of different light beams and the 355° adjustment of the light direction allows multiple solutions and scenarios in retail stores, commercial spaces, museums, exhibition halls. Supplied with metallized mirrored thermoplastic reflector with standard lens with medium beam. Reflectors for narrow or wide beam available upon request. Available in 3000K and in white or black finish.

CODICE CODE		FONTE LUMINOSA LIGHT SOURCES	kg
	<b>B77001.037.4001</b>	Potenza assorbita apparecchio / Luminaire power consumption 37W	0,90
	<b>B77002.037.4001</b>	Flusso luminoso apparecchio / Luminaire luminous flux 4450lm 3000K Ra>85 30° 220-240V AC ON-OFF	
		<b>IP20 850°</b>	

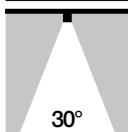

**STANDARD**

Ottica per fascio medio.  
Flood optic.

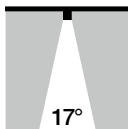

**XMR1**

Ottica per fascio stretto.  
Spot optic.

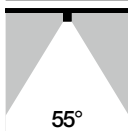

**XMR3**

Ottica per fascio largo.  
Wide flood optic.

Fotometrie disponibili [www.panzeri.it](http://www.panzeri.it) / Photometric data available at [www.panzeri.it](http://www.panzeri.it)

### CODICI COLORI DISPONIBILI / COLOUR CODES AVAILABLE

**01** bianco  
white

**02** nero  
black



# QUEENS 25



Proiettore in pressofusione di alluminio a dissipazione termica passiva per binario elettrificato trifase, con LED ad alta efficienza e adattatore integrato. Può essere ruotato rispetto all'asse verticale fino a 355° e di 90° verso l'alto. Riflettore termoplastico metallizzato a specchio con ottica standard a fascio medio e ottiche per fascio stretto, largo o molto largo disponibili su richiesta. Disponibile nelle versioni 3000K e 4000K e nei colori bianco e nero.

Die-cast aluminium spotlight with passive thermal dissipation for three-phase electrified track, equipped with high efficiency LED and integrated adapter. It can rotate up to 355° with respect to the vertical axis and pivot up to 90° upwards. Mirror-metallized thermoplastic reflector with flood standard light beam and spot, wide flood or extra wide flood optics available on request. Available in 3000K and 4000K versions, in white and black colours.

	CODICE CODE	FONTI LUMINOSE LIGHT SOURCES	kg
	<b>XM751-30-01-3K</b> <b>XM751-30-02-3K</b>	Potenza assorbita apparecchio / Luminaire power consumption 30W Flusso luminoso apparecchio / Luminaire luminous flux 2552lm 3000K Ra>85 29° 220-240V AC ON-OFF IP20 850°	1,04
	<b>XM751-30-01-4K</b> <b>XM751-30-02-4K</b>	Potenza assorbita apparecchio / Luminaire power consumption 30W Flusso luminoso apparecchio / Luminaire luminous flux 2617lm 4000K Ra>85 29° 220-240V AC ON-OFF IP20 850°	1,04
	<b>STANDARD</b>	Ottica per fascio medio. Flood optic.	
	<b>XMR5</b>	Ottica per fascio stretto Spot optic	0,01
	<b>XMR7</b>	Ottica per fascio largo Wide flood optic	0,01
	<b>XMR8</b>	Ottica per fascio largo Wide flood optic	0,01

Fotometrie disponibili [www.panzeri.it](http://www.panzeri.it) / Photometric data available at [www.panzeri.it](http://www.panzeri.it) UGR < 16 in funzione delle condizioni di installazione / UGR < 16 depending on installation conditions

### CODICI COLORI DISPONIBILI / COLOUR CODES AVAILABLE

- 01** bianco / white
- 02** nero / black



# QUEENS 20



Queens 20 è un proiettore dalle dimensioni compatte per binari elettrificati trifase, progettato per LED COB di ultima generazione. La disponibilità di differenti fasci luminosi consente molteplici soluzioni e regie luminose nel retail, spazi commerciali, musei ed aree espositive. Viene fornito completo di riflettore termoplastico metallizzato a specchio con ottica standard a fascio medio. Ottiche per fascio stretto o largo ordinabili su richiesta. Disponibile nella versione 3000K e nei colori bianco e nero.

Queens 20 is a compact projector for tri-phase electrified tracks, engineered with COB LEDs of latest generation. The availability of different light beams allows multiple solutions and scenarios in retail stores, commercial spaces, museums, exhibition halls. Supplied with metallized mirrored thermoplastic reflector with standard lens with a medium beam. Reflectors for narrow or wide beam available upon request. Available in 3000K and in white or black finish.

	CODICE CODE	FONTI LUMINOSE LIGHT SOURCES	kg
	<b>B76001.026.2501</b>	Potenza assorbita apparecchio / Luminaire power consumption 26W	0,40
	<b>B76002.026.2501</b>	Flusso luminoso apparecchio / Luminaire luminous flux 1890lm 3000K Ra>90 30° 220-240V AC ON-OFF	
		 IP20 850° 	

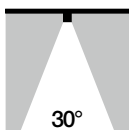
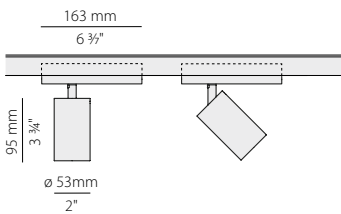

**STANDARD**

Ottica per fascio medio.  
Flood optic.

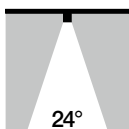

**XMR5**

Ottica per fascio stretto  
Spot optic

0,01

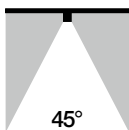

**XMR7**

Ottica per fascio largo  
Wide flood optic

0,01

Fotometrie disponibili [www.panzeri.it](http://www.panzeri.it) / Photometric data available at [www.panzeri.it](http://www.panzeri.it)

CODICI COLORI DISPONIBILI / COLOUR CODES AVAILABLE

**01** bianco  
white

**02** nero  
black





# QUEENS 10



Proiettore in pressofusione di alluminio a dissipazione termica passiva con adattatore per binario elettrificato trifase, equipaggiato con LED ad alta efficienza. Può essere ruotato rispetto all'asse verticale di 355° e di 90° verso l'alto. Cilindro antiabbagliamento di serie. Riflettore termoplastico metallizzato a specchio con ottica standard a fascio medio e ottiche per fascio stretto o largo disponibili su richiesta. Disponibile nella versione 3000K e nei colori bianco e nero.

Die-cast aluminium spotlight with passive thermal dissipation with adapter for threephase electrified track, equipped with high efficiency LED. It can rotate up to 355° with respect to the vertical axis and pivot up to 90° upwards. Standard anti-glare snoot. Mirror-metallized thermoplastic reflector with flood standard light beam and spot or wide flood optics available on request. Available in 3000K version, in white and black colours.

	CODICE CODE	FONTI LUMINOSE LIGHT SOURCES	kg
	<b>XM748-12-01-3K</b> <b>XM748-12-02-3K</b>	Potenza assorbita apparecchio / Luminaire power consumption 12W Flusso luminoso apparecchio / Luminaire luminous flux 1221lm 3000K Ra>90 30° 220-240V AC ON-OFF IP20 850°	0,50

	<b>STANDARD</b>	Ottica per fascio medio. Flood optic.	
	<b>XMR5</b>	Ottica per fascio stretto Spot optic	0,01
	<b>XMR7</b>	Ottica per fascio largo Wide flood optic	0,01

Fotometrie disponibili [www.panzeri.it](http://www.panzeri.it) / Photometric data available at [www.panzeri.it](http://www.panzeri.it)

UGR < 11 in funzione delle condizioni di installazione / UGR < 11 depending on installation conditions

### CODICI COLORI DISPONIBILI / COLOUR CODES AVAILABLE

- 01** bianco / white
- 02** nero / black



# QUEENS



Sistema di binari trifase a tre accensioni (tensione di rete 230/250V, tensione di rete industriale 380/440V, carico complessivo 16A) disponibile in tre differenti lunghezze per applicazioni a plafone e a sospensione. Il sistema è costruito in lega di alluminio estruso con cavi conduttori in rame alloggiati all'interno di profilati estrusi in PVC ad alta resistenza di isolamento. Il sistema è a sezione quadra in colore bianco o nero e comprende un'ampia varietà di accessori e giunti di collegamento che lo rendono ideale nella progettazione illuminotecnica per flessibilità e versatilità.

System of three-phase tracks with three circuits (power supply 230/250V, industrial power supply 380/440V, total load 16A) available in three different lengths for installation at the ceiling or suspended. The system is made of extruded aluminium alloy with copper wires located inside the extruded PVC profiles with high insulating properties. The system is square-shaped in colour white or black and includes a wide range of accessories and joints that makes it extremely flexible and versatile in lighting design.

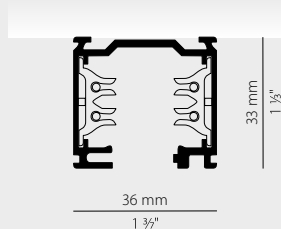

## THREE-PHASE ELECTRIFIED TRACK

IP20 850°

CODICE / CODE	L MM	L INCHES	kg
<b>XM7501-100</b>	1000	39 3/8"	0,80
<b>XM7502-100</b>	1000	39 3/8"	0,80
<b>XM7501-200</b>	2000	78 4/8"	1,60
<b>XM7502-200</b>	2000	78 4/8"	1,60
<b>XM7501-300</b>	3000	118 1/8"	2,40
<b>XM7502-300</b>	3000	118 1/8"	2,40

## CODICI COLORI DISPONIBILI / COLOUR CODES AVAILABLE

**01** bianco  
white

**02** nero  
black

## ACCESSORI / ACCESSORIES

**XM7501**  
**XM7502**  
Adattatore elettromeccanico 6A, portata 5kg, per binario elettrificato trifase.  
Electro/mechanical adapter 6A, mechanical load 5kg, for three-phase electrified track.

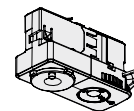

kg

0,05

**XM76ADX01**  
**XM76ADX02**  
Alimentazione destra per binario elettrificato trifase.  
Right live-end for three-phase electrified track.

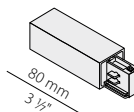

0,09

**XM76ASX01**  
**XM76ASX02**  
Alimentazione sinistra per binario elettrificato trifase.  
Left live-end for three-phase electrified track.

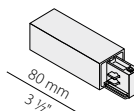



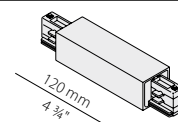

0,09

**XM76A01**  
**XM76A02**  
Alimentazione centrale e giunzione lineare per binario elettrificato trifase.  
Central connector and straight joint for three-phase electrified track.

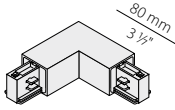
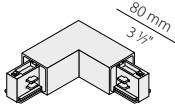
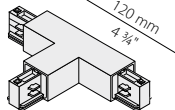
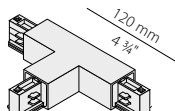
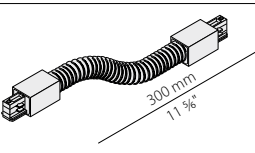

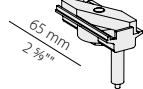
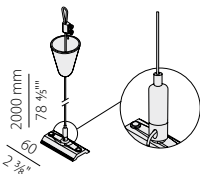
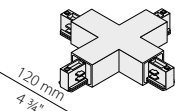
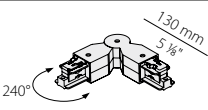
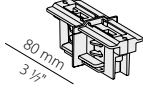
0,17

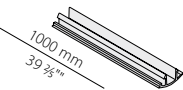
	kg
<b>XM76LI01</b> <b>XM76LI02</b> Giunzione a "L" interna per binario elettrificato trifase. Internal "L" joint for three-phase electrified track.	 0,17
<b>XM76LE01</b> <b>XM76LE02</b> Giunzione a "L" esterna per binario elettrificato trifase. External "L" joint for three-phase electrified track.	 0,17
<b>XM76TDX01</b> <b>XM76TDX02</b> Giunzione a "T" destra per binario elettrificato trifase. Right "T" joint for three-phase electrified track.	 0,20
<b>XM76TSX01</b> <b>XM76TSX02</b> Giunzione a "T" sinistra per binario elettrificato trifase. Left "T" joint for three-phase electrified track.	 0,20
<b>XM76F01</b> <b>XM76F02</b> Giunzione flessibile per binario elettrificato trifase. Flexible joint for three-phase electrified track.	 0,25
<b>XM76U01</b> <b>XM76U02</b> Giunzione lineare senza contatti per binario elettrificato trifase. Mechanical straight joint for three-phase electrified track.	 0,04
<b>XM76B01</b> <b>XM76B02</b> Adattatore meccanico con bloccacavo automatico per binario elettrificato trifase. Mechanical adapter with automatic locking for three-phase electrified track.	 0,10
<b>XM76S01</b> <b>XM76S02</b> Kit di sospensione con fune in acciaio di lunghezza 2m (78,7") e piattina per binario elettrificato trifase. Suspension kit with 2m (78,7") long steel wire and plate for three-phase electrified track.	 0,05
<b>XM76X01</b> <b>XM76X02</b> Giunzione a "X" per binario elettrificato trifase. "X" joint for three-phase electrified track.	 0,30
<b>XM76M01</b> <b>XM76M02</b> Giunzione mobile per binario elettrificato trifase. Mobile joint for three-phase electrified track.	 0,17
<b>XM76Q01</b> <b>XM76Q02</b> Giunzione lineare con contatti e con blocco per binario elettrificato trifase. Electrical straight joint with stop for three-phase electrified track.	 0,05
<b>XM76K</b> Kit per attacco a soffitto per binario elettrificato trifase. Ceiling kit for three-phase electrified track.	 0,02
<b>XM76E01</b> <b>XM76E02</b> Testata di chiusura per binario elettrificato trifase. End cap for three-phase electrified track.	 0,01
<b>XM76C01</b> <b>XM76C02</b> Copertura di lunghezza 1000mm (39,4") per binario elettrificato trifase. Cover 1000mm (39,4") long for three-phase electrified track.	 0,06



# SOHO 20



355°

Proiettore in pressofusione di alluminio con LED ad alta efficienza e adattatore integrato per binario elettrificato a bassa tensione 48V. Cilindro antiabbagliamento e vetro zigrinato di serie. Riflettore termoplastico metallizzato a specchio con ottica standard a fascio medio e ottiche per fascio stretto o largo disponibili su richiesta. Disponibile nella versione 3000K e nei colori bianco e nero.

Die-cast aluminium spotlight with high efficiency LED and integrated adapter for 48V low voltage electrified track. Standard anti-glare snoot and prismatic spread lens. Mirror-metallized thermoplastic reflector with flood standard light beam and spot or wide flood optics available on request. Available in 3000K version, in white and black colours.

	CODICE CODE	FONTI LUMINOSE LIGHT SOURCES	kg
	<b>B75401.026.2516</b> <b>B75402.026.2516</b>	Potenza assorbita apparecchio / Luminaire power consumption 26W Flusso luminoso apparecchio / Luminaire luminous flux 1890lm 3000K Ra>90 30° 48V DC ON-OFF IP20 850°	0,40
	<b>B75401.026.2519</b> <b>B75402.026.2519</b>	Potenza assorbita apparecchio / Luminaire power consumption 26W Flusso luminoso apparecchio / Luminaire luminous flux 1890lm 3000K Ra>90 30° 48V DC dimmable (DALI) IP20 850°	0,40
	<b>STANDARD</b>	Ottica per fascio medio. Flood optic.	
	<b>XMR5</b>	Ottica per fascio stretto Spot optic	0,01
	<b>XMR7</b>	Ottica per fascio largo Wide flood optic	0,01
	<b>XMR12</b>	Cilindro interno colore oro satinato Internal satin gold cylinder	0,02

Fotometrie disponibili [www.panzeri.it](http://www.panzeri.it) / Photometric data available at [www.panzeri.it](http://www.panzeri.it)

UGR < 16 in funzione delle condizioni di installazione / UGR < 16 depending on installation conditions

CODICI COLORI DISPONIBILI / COLOUR CODES AVAILABLE

**01** bianco  
white

**02** nero  
black



# SOHO 10



Proiettore in pressofusione di alluminio con LED ad alta efficienza e adattatore integrato per binario elettrificato a bassa tensione 48V. Cilindro antiabbagliamento e vetro zigrinato di serie. Riflettore termoplastico metallizzato a specchio con ottica standard a fascio medio e ottiche per fascio stretto o largo disponibili su richiesta. Disponibile nella versione 3000K e nei colori bianco e nero.

Die-cast aluminium spotlight with high efficiency LED and integrated adapter for 48V low voltage electrified track. Standard anti-glare snoot and prismatic spread lens. Mirror-metallized thermoplastic reflector with flood standard light beam and spot or wide flood optics available on request. Available in 3000K version, in white and black colours.

CODICE CODE	FONTI LUMINOSE LIGHT SOURCES	kg
-------------	------------------------------	----

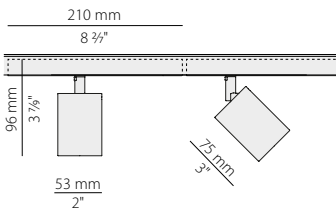

**B75301.018.2516**

**B75302.018.2516**

Potenza assorbita apparecchio / Luminaire power consumption 18W  
Flusso luminoso apparecchio / Luminaire luminous flux 1436lm  
3000K Ra>90 30° 48V DC ON-OFF

IP20 850°

0,40

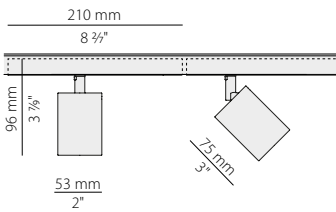

**B75301.018.2519**

**B75302.018.2519**

Potenza assorbita apparecchio / Luminaire power consumption 18W  
Flusso luminoso apparecchio / Luminaire luminous flux 1436lm  
3000K Ra>90 30° 48V DC dimmable (DALI)

IP20 850°

0,40

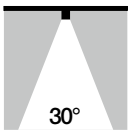

**STANDARD**

Ottica per fascio medio.  
Flood optic.

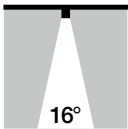

**XMR10**

Ottica per fascio stretto  
Spot optic

0,04

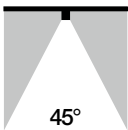

**XMR11**

Ottica per fascio largo  
Wide flood optic

0,04



**XMR12**

Cilindro interno colore oro satinato  
Internal satin gold cylinder

0,02

Fotometrie disponibili [www.panzeri.it](http://www.panzeri.it) / Photometric data available at [www.panzeri.it](http://www.panzeri.it)

UGR < 16 in funzione delle condizioni di installazione / UGR < 16 depending on installation conditions

## CODICI COLORI DISPONIBILI / COLOUR CODES AVAILABLE

**01** bianco  
white

**02** nero  
black





# SOHO 5



Proiettore in pressofusione di alluminio con LED ad alta efficienza e adattatore integrato per binario elettrificato a bassa tensione 48V. Completo di cilindro antiabbagliamento e lente per fascio stretto in materiale termoplastico.  
Disponibile nella versione 3000K e nei colori bianco e nero.

Die-cast aluminium spotlight with high efficiency LED and integrated adapter for 48V low voltage electrified track. Complete with standard anti-glare snoot and thermoplastic lens for narrow beam. Available in 3000K version, in white and black colours.

NOVELTY	CODICE CODE	FONTI LUMINOSE LIGHT SOURCES	kg
	<b>B75201.008.2416</b> <b>B75202.008.2416</b>	Potenza assorbita apparecchio / Luminaire power consumption 7,3W Flusso luminoso apparecchio / Luminaire luminous flux 613lm 3000K Ra>90 14° 48V DC ON-OFF IP20 850°	0,30
	<b>B75201.008.2419</b> <b>B75202.008.2419</b>	Potenza assorbita apparecchio / Luminaire power consumption 7,3W Flusso luminoso apparecchio / Luminaire luminous flux 613lm 3000K Ra>90 14° 48V DC dimmable (DALI) IP20 850°	0,30

Fotometrie disponibili [www.panzeri.it](http://www.panzeri.it) / Photometric data available at [www.panzeri.it](http://www.panzeri.it)

### CODICI COLORI DISPONIBILI / COLOUR CODES AVAILABLE

- 01** bianco / white
- 02** nero / black



# SOHO S 15



Elegante proiettore a sospensione per installazioni su binari elettrificati 48V DC. L'apparecchio è equipaggiato con LED COB ad alta efficienza e può essere personalizzato con diversi accessori per un miglior comfort visivo. Le ottiche arretrate e lo snoot di serie riducono al minimo l'abbagliamento. Viene fornito completo di riflettore termoplastico metallizzato a specchio con ottica standard a fascio medio. Ottiche per fascio stretto o largo ordinabili su richiesta. Il suo design, dalle linee compatte e dalla sottile testa cilindrica, si inserisce facilmente in numerosi contesti, dal retail, all'hospitality, al residenziale. Disponibile nella versione 3000K e nei colori bianco e nero.

Elegant suspended projector for installation on 48V DC electrified tracks. The fitting is equipped with high-efficiency COB LED and it can be customized with various accessories for an improved visual comfort. The recessed lens and the snoot minimize the glare. Supplied with metallized mirrored thermoplastic reflector with standard lens with medium beam. Reflectors for narrow or wide beam available upon request. The minimal and compact design of the cylindrical head suits a variety of project applications in retail stores, hospitality, residential spaces. Available in 3000K in the finishes white or black.

CODICE CODE	FONTI LUMINOSE LIGHT SOURCES	kg
-------------	------------------------------	----



**B70001.018.2516**  
**B70002.018.2516**

Potenza assorbita apparecchio / Luminaire power consumption 18W  
Flusso luminoso apparecchio / Luminaire luminous flux 1705lm  
3000K Ra>90 30° 48V DC ON-OFF

0,50

IP20 850°

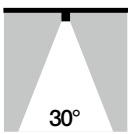
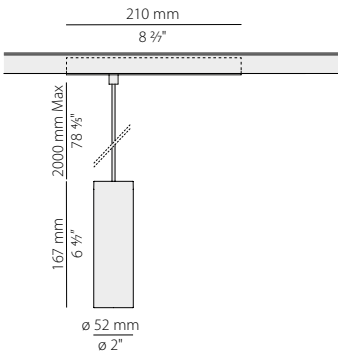

**STANDARD**

Ottica per fascio medio.  
Flood optic.

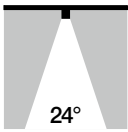

**XMR5**

Ottica per fascio stretto  
Spot optic

0,01

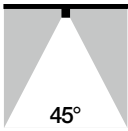

**XMR7**

Ottica per fascio largo  
Wide flood optic

0,01

Fotometrie disponibili [www.panzeri.it](http://www.panzeri.it) / Photometric data available at [www.panzeri.it](http://www.panzeri.it)

UGR < 11 in funzione delle condizioni di installazione / UGR < 11 depending on installation conditions

### CODICI COLORI DISPONIBILI / COLOUR CODES AVAILABLE

**01** bianco  
white

**02** nero  
black



# SOHO LINE



Modulo lineare a luce diffusa per binari elettrificati a bassa tensione 48V per applicazioni soffitto/parete, sospensione e incasso, con schermo in policarbonato opale. Trasformatore elettronico remoto per binario 48V da ordinare separatamente. Disponibile in colore bianco o nero. Non compatibile con sistema DALI.

Linear diffused LED module with opal polycarbonate screen for 48V low voltage electrified tracks for ceiling/wall, suspension and recessed applications. Electronic transformer for remote use for 48V track to order separately. White and black finishes are available. Not compatible with DALI system.

	CODICE CODE	FONTI LUMINOSE LIGHT SOURCES	kg
	<b>B47001.060.0416</b> <b>B47002.060.0416</b>	Potenza assorbita apparecchio / Luminaire power consumption 12W Flusso luminoso apparecchio / Luminaire luminous flux 740lm 3000K Ra>90 48V DC ON-OFF IP20	0,30
	<b>B47001.090.0416</b> <b>B47002.090.0416</b>	Potenza assorbita apparecchio / Luminaire power consumption 19W Flusso luminoso apparecchio / Luminaire luminous flux 1244lm 3000K Ra>90 48V DC ON-OFF IP20	0,30

Fotometrie disponibili [www.panzeri.it](http://www.panzeri.it) / Photometric data available at [www.panzeri.it](http://www.panzeri.it)

### CODICI COLORI DISPONIBILI / COLOUR CODES AVAILABLE

- 01** bianco / white
- 02** nero / black

# SOHO IN



Sistema di binari a bassa tensione 48V, disponibile in tre differenti lunghezze per applicazioni ad incasso. Il sistema è costruito in lega di alluminio estruso verniciato poliestere, predisposto per alloggiare i proiettori provvisti di adattatore 48V. Possibilità di regolazione DALI. Il sistema è a sezione quadrata, in colore nero. Disponibile un'ampia varietà di accessori e giunti di collegamento.

System of 48V electrified tracks, available in three different lengths for recessed use. The system is made of extruded aluminium alloy with polyester coating, suitable to host spotlights equipped with 48V adapter. Possibility of DALI dimming. The system is square-shaped, in black colour. Wide range of available accessories and joints.

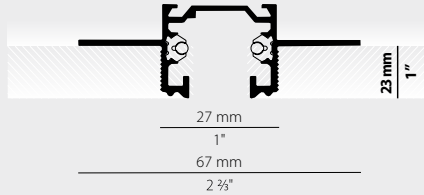

## TRIMLESS RECESSED ELECTRIFIED TRACK 48V DC

IP20 850°

CODICE / CODE	L MM	L INCHES	kg
<b>XM44602-100</b>	1000	39 3/8"	0,73
<b>XM44602-200</b>	2000	78 7/8"	1,45
<b>XM44602-300</b>	3000	118 1/8"	2,18

## CODICI COLORI DISPONIBILI / COLOUR CODES AVAILABLE

**02** nero  
black

## ACCESSORI / ACCESSORIES

Accessorio	kg
<b>XM44501-C</b> <b>XM44502-C</b> Copertura di lunghezza 1000mm (39,4") per binario elettrificato 48V DC. Cover 1000mm (39,4") long for 48V DC electrified track.	0,10
<b>XM44602-ADX</b> Alimentazione destra per binario elettrificato 48V DC da incasso. Right live-end for 48V DC recessed electrified track.	0,04
<b>XM44602-ASX</b> Alimentazione sinistra per binario elettrificato 48V DC da incasso. Left live-end for 48V DC recessed electrified track.	0,04
<b>XM44602-A</b> Alimentazione centrale per binario elettrificato 48V DC da incasso. Central connector for 48V DC recessed electrified track.	0,07
<b>XM44502-UE</b> Giunto lineare per binario elettrificato 48V DC. Straight joint for 48V DC electrified track.	0,02
<b>XM44502-UM</b> Giunto lineare senza contatti per binario elettrificato 48V DC. Mechanical straight joint for 48V DC electrified track.	0,01

**XM44602-LI**

Giunzione a "L" interna per binario elettrificato 48V DC a incasso.  
Internal "L" joint for 48V DC recessed electrified track.

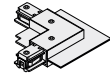

0,06

**NEW****XM44602-LE**

Giunzione a "L" esterna per binario elettrificato 48V DC a incasso.  
External "L" joint for 48V DC recessed electrified track.

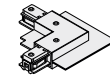

0,06

**NEW****YDV.048.150.A02**

Trasformatore elettronico DALI, 150W 48V DC, per binario elettrificato 48V DC.  
DALI electronic transformer, 150W 48V DC, for 48V DC electrified track.

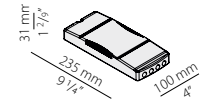

0,40

**YDV.048.075.A01**

Trasformatore elettronico, 75W 48V DC, per binario elettrificato 48V DC.  
Electronic transformer, 75W 48V DC, for 48V DC electrified track.

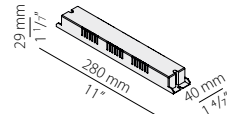

0,38

**YDV.048.150.A01**

Trasformatore elettronico, 150W 48V DC, per binario elettrificato 48V DC.  
Electronic transformer, 150W 48V DC, for 48V DC electrified track.

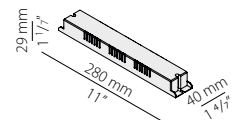

0,38

**XM44602-E**

Testata di chiusura per binario elettrificato 48V DC da incasso.  
End cap for 48V DC recessed electrified track.

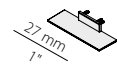

0,07

**XM446-P**

Piattina per fissaggio a plafone binario elettrificato 48V DC da incasso.

**ACCESSORIO OBBLIGATORIO DA POSIZIONARE OGNI METRO CIRCA.**

Plate for fixing ceiling pendants for 48V DC recessed electrified track.

**MANDATORY ACCESSORY TO BE POSITIONED EVERY METER APPROX.**

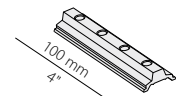

0,05

# SOHO OUT

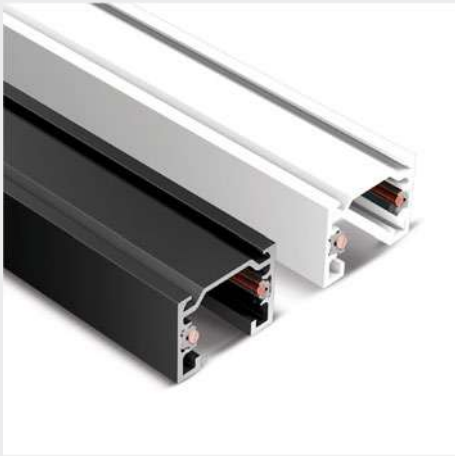

Sistema di binari a bassa tensione 48V, disponibile in tre differenti lunghezze per applicazioni a soffitto/parete e a sospensione. Il sistema è costruito in lega di alluminio estruso verniciato poliestere, predisposto per alloggiare i proiettori provvisti di adattatore 48V. Possibilità di regolazione DALI. Il sistema è a sezione quadra, in colore bianco e nero. Disponibile un'ampia varietà di accessori e giunti di collegamento.

System of 48V electrified tracks, available in three different lengths for ceiling/wall or suspended use. The system is made of extruded aluminium alloy with polyester coating, suitable to host spotlights equipped with 48V adapter. Possibility of DALI dimming. The system is square-shaped, in white or black colour. Wide range of available accessories and joints.

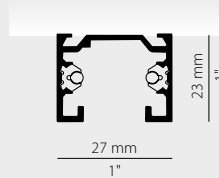

## ELECTRIFIED TRACK 48V DC

IP20 850°

CODICE / CODE	L MM	L INCHES	kg
<b>XM44501-100</b>	1000	39 3/8"	0,50
<b>XM44502-100</b>	1000	39 3/8"	0,50
<b>XM44501-200</b>	2000	78 7/8"	1,00
<b>XM44502-200</b>	2000	78 7/8"	1,00
<b>XM44501-300</b>	3000	118 1/8"	1,70
<b>XM44502-300</b>	3000	118 1/8"	1,70

## CODICI COLORI DISPONIBILI / COLOUR CODES AVAILABLE

**01** bianco  
white

**02** nero  
black

## ACCESSORI / ACCESSORIES

Accessories	kg
<b>XM44501-C</b> <b>XM44502-C</b> Copertura di lunghezza 1000mm (39,4") per binario elettrificato 48V DC. Cover 1000mm (39,4") long for 48V DC electrified track.	0,10
<b>XM44501-ADX</b> <b>XM44502-ADX</b> Alimentazione destra per binario elettrificato 48V DC a sospensione o a soffitto. Right live-end for 48V DC suspended or ceiling electrified track.	0,04
<b>XM44501-ASX</b> <b>XM44502-ASX</b> Alimentazione sinistra per binario elettrificato 48V DC a sospensione o a soffitto. Left live-end for 48V DC suspended or ceiling electrified track.	0,04
<b>XM44501-A</b> <b>XM44502-A</b> Alimentazione centrale per binario elettrificato 48V DC a sospensione o a soffitto. Central connector for 48V DC suspended or ceiling electrified track.	0,06
<b>XM44501-LI</b> <b>XM44502-LI</b> Giunzione a "L" interna per binario elettrificato 48V DC a sospensione o a soffitto. Internal "L" joint for 48V DC suspended or ceiling electrified track.	0,06

**XM44501-LE****XM44502-LE**

Giunzione a "L" esterna per binario elettrificato 48V DC a sospensione o a soffitto.  
External "L" joint for 48V DC suspended or ceiling electrified track.

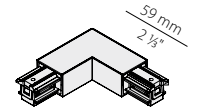

0,06

**XM44501-UE****XM44502-UE**

Giunto lineare per binario elettrificato 48V DC.  
Straight joint for 48V DC electrified track.

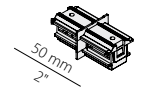

0,02

**XM44501-UM****XM44502-UM**

Giunto lineare senza contatti per binario elettrificato 48V DC.  
Mechanical straight joint for 48V DC electrified track.

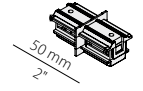

0,01

**YDV.048.150.A02**

Trasformatore elettronico DALI, 150W 48V DC, per binario elettrificato 48V DC.  
DALI electronic transformer, 150W 48V DC, for 48V DC electrified track.

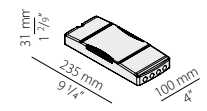

0,40

**NOVELTY****YDV.048.075.A01**

Trasformatore elettronico, 75W 48V DC, per binario elettrificato 48V DC.  
Electronic transformer, 75W 48V DC, for 48V DC electrified track.

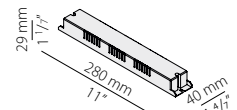

0,38

**NOVELTY****YDV.048.150.A01**

Trasformatore elettronico, 150W 48V DC, per binario elettrificato 48V DC.  
Electronic transformer, 150W 48V DC, for 48V DC electrified track.

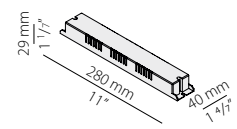
**NOVELTY****XM44501-E****XM44502-E**

Testata di chiusura per binario elettrificato 48V DC a sospensione o a soffitto.  
End cap for 48V DC suspended or ceiling electrified track.

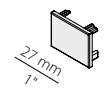

0,10

**XM44501-S****XM44502-S**

Kit di sospensione con fune in acciaio di lunghezza 2m (78,7") e piattina per binario elettrificato 48V DC.  
Suspension kit with 2m (78,7") long steel wire and plate for 48V DC electrified track.

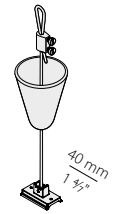

0,03

**XM44501-K****XM44502-K**

Kit per attacco a soffitto per binario elettrificato 48V DC.  
Ceiling kit for 48V DC electrified track.



0,03

## **INCASSI / RECESSED**

167 **CLICK CLACK**  
168 **EAST**  
174 **EDDIE**  
175 **JAMES**  
176 **JARVIS**  
177 **JESSIE**  
184 **JOE**  
173 **MOAI**  
178 **NICK**  
180 **RALLY TRIM**  
182 **SID**  
171 **STEP BY STEP**  
183 **TAYLOR**





# CLICK CLACK

Enzo Panzeri 2019



Click clack è un incasso in gesso con un foro di 35mm. Garantisce massima praticità grazie ad uno speciale meccanismo "push&pull" che consente il ribassamento del portalamпада per la sostituzione della sorgente luminosa, evitando invasivi interventi di manutenzione.

Click clack is a plaster recessed fitting with a 35mm hole. It guarantees maximum functionality thanks to a special push&pull mechanism that allows the lamp holder to be lowered to replace the light source, avoiding invasive maintenance operations.



**XGR1212**  
XM3 lampholder with terminal block  
LED retrofit bulb 4W GU10 Ø 35mm 3000K Ra80 330lm (no dimming)

IP20

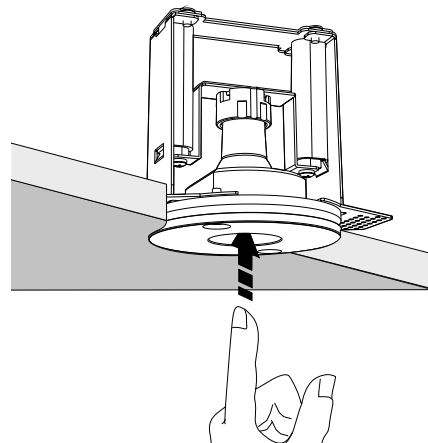
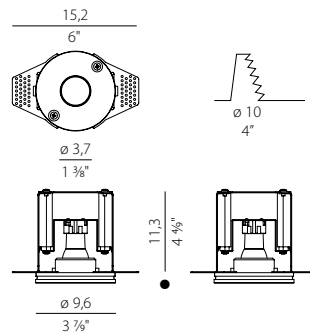

**+ Electric options**  
(see details on page 189)

XM5/GU10-35 retrofit lamp

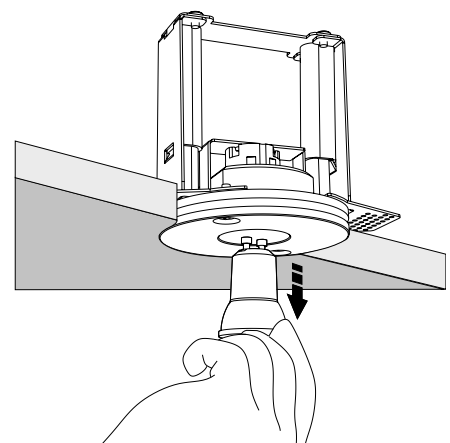

- Minima altezza di ingombro dell'apparecchio (le quote minime del vano di incasso sono riportate sul foglio di istruzioni)

Minimum height of the appliance (see the minimum values for housing compartment in the instruction sheets)

Lampadina non inclusa, vedi electric options.  
Da acquistare separatamente.

Bulb not included, see electric options.  
Please purchase separately.

Fotometrie disponibili [www.panzeri.it](http://www.panzeri.it) / Photometric data available at [www.panzeri.it](http://www.panzeri.it)

CODICI COLORI DISPONIBILI / COLOUR CODES AVAILABLE

42 gesso  
plaster



# EAST



Incassi in gesso fissi o orientabili. I prodotti sono venduti con alimentazione di serie GU10. Le elettrificazioni opzionali e i relativi driver sono forniti separatamente al prodotto e vanno eventualmente sostituiti a quelli di serie.

Fixed or adjustable plaster recessed luminaires. The products are sold with GU10 fittings. Different types of electricity supply and the related drivers substitute the series fitting.

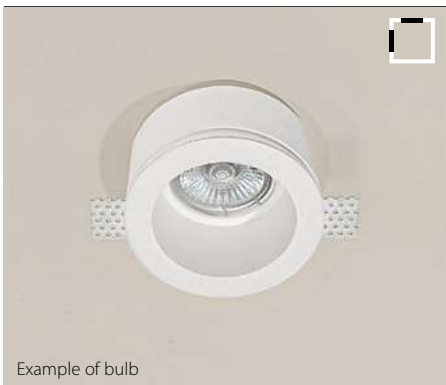

### XGR0997

XM3 lampholder with terminal block max 50W GU10

IP20

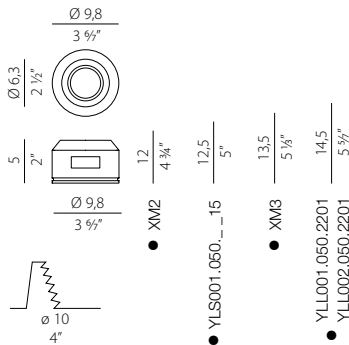

#### + Electric options

(see details on page 188)

#### LAMP

YLL001.050.2201 retrofit lamp  
YLL002.050.2201 retrofit lamp  
YLS001.050.\_.15 spot LED  
XM2 lampholder with terminal block

#### DRIVER

XM6-15 UNI  
XM6-20 UNI ★  
XM6-20 D/P MULTI ★  
XM6-25 D/P MULTI

kg

0,24



### XGQ0998

XM3 lampholder with terminal block max 50W GU10

IP20

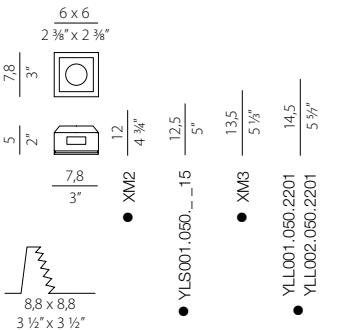

#### + Electric options

(see details on page 188)

#### LAMP

YLL001.050.2201 retrofit lamp  
YLL002.050.2201 retrofit lamp  
YLS001.050.\_.15 spot LED  
XM2 lampholder with terminal block

#### DRIVER

XM6-15 UNI  
XM6-20 UNI ★  
XM6-20 D/P MULTI ★  
XM6-25 D/P MULTI

0,17

### XM0998 85x85x155mm

Cassaforma per incasso in muratura in lamiera zincata.

**Gruppo di alimentazione da prevedere remoto esternamente alla cassaforma.**

Galvanized sheet housing to be recessed in brick wall or concrete.

**Electrical power supply must be remote outside of the housing.**

0,45

I prodotti sono venduti con cablaggio di serie GU10. Le elettrificazioni opzionali sono fornite separatamente al prodotto e vanno perciò sostituite a quelle di serie.

The products are sold with GU10 fittings. Different types of electric options are supplied separately and substitute the series fitting.

- Minima altezza di ingombro dell'apparecchio (le quote minime del vano di incasso sono riportate sul foglio di istruzioni) Minimum height of the appliance (see the minimum values for housing compartment in the instruction sheets)
- ★ Dimensione dell'alimentatore maggiore del foro d'incasso, dunque installare l'alimentatore in apposito vano d'ispezione. Power supply unit is larger than the recess hole, install the power supply unit in a special inspection compartment.

**XGQ0998-GL**

XM3 lampholder with terminal block max 50W GU10

IP20

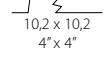
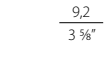
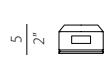
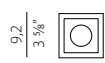
$$\frac{6 \times 6}{2 \frac{3}{8}'' \times 2 \frac{3}{8}''}$$

 $\frac{12}{4 \frac{3}{8}''}$ 
 $\frac{12,5}{5''}$ 
 $\frac{13,5}{5 \frac{1}{8}''}$ 
 $\frac{14,5}{5 \frac{9}{16}''}$ 

- XM2

- YLS001.050.\_15

- XM3

- YLL001.050.2201
- YLL002.050.2201

**+ Electric options**

(see details on page 188)

## LAMP

YLL001.050.2201 retrofit lamp

YLL002.050.2201 retrofit lamp

YLS001.050.\_15 spot LED

XM2 lampholder with terminal block

## DRIVER

XM6-15 UNI

XM6-20 UNI \*

XM6-20 D/P MULTI \*

XM6-25 D/P MULTI

0,33

**XM0998-GL** 95x95x155mm

Cassaforma per incasso in muratura in lamiera zincata.

**Gruppo di alimentazione da prevedere remoto esternamente alla cassaforma.**

Galvanized sheet housing to be recessed in brick wall or concrete.

**Electrical power supply must be remote outside of the housing.**

0,52

**XGQ1004**

XM3 lampholder with terminal block max 50W GU10

IP20

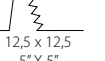
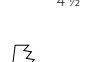
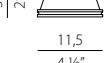
$$\frac{7 \times 7}{2 \frac{3}{4}'' \times 2 \frac{3}{4}''}$$

 $\frac{11,5}{4 \frac{1}{2}''}$ 
 $\frac{11,5}{4 \frac{1}{2}''}$ 
 $\frac{13,5}{5 \frac{1}{8}''}$ 
 $\frac{14,5}{5 \frac{3}{8}''}$ 

- XM2

- YLS001.050.\_15

- XM3

- YLL001.050.2201
- YLL002.050.2201

**+ Electric options**

(see details on page 188)

## LAMP

YLL001.050.2201 retrofit lamp

YLL002.050.2201 retrofit lamp

YLS001.050.\_15 spot LED

XM2 lampholder with terminal block

## DRIVER

XM6-15 UNI

XM6-20 UNI \*

XM6-20 D/P MULTI \*

XM6-25 D/P MULTI

0,46

**XGQ1004-GL**

XM3 lampholder with terminal block max 50W GU10

IP20

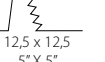
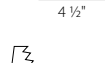
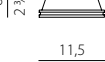
$$\frac{7 \times 7}{2 \frac{3}{4}'' \times 2 \frac{3}{4}''}$$

 $\frac{12}{4 \frac{3}{8}''}$ 
 $\frac{14}{5 \frac{1}{2}''}$ 
 $\frac{14}{5 \frac{1}{2}''}$ 
 $\frac{15}{6''}$ 

- XM2

- YLS001.050.\_15

- XM3

- YLL001.050.2201
- YLL002.050.2201

**+ Electric options**

(see details on page 188)

## LAMP

YLL001.050.2201 retrofit lamp

YLL002.050.2201 retrofit lamp

YLS001.050.\_15 spot LED

XM2 lampholder with terminal block

## DRIVER

XM6-15 UNI

XM6-20 UNI \*

XM6-20 D/P MULTI \*

XM6-25 D/P MULTI

0,56

**XM1004/1004-GL/1030** 125x125x155mm

Cassaforma per incasso in muratura in lamiera zincata.

**Gruppo di alimentazione da prevedere remoto esternamente alla cassaforma.**

Galvanized sheet housing to be recessed in brick wall or concrete.

**Electrical power supply must be remote outside of the housing.**

0,71

I prodotti sono venduti con cablaggio di serie GU10.

Le elettrificazioni opzionali sono fornite separatamente al prodotto e vanno perciò sostituite a quelle di serie.

The products are sold with GU10 fittings.

Different types of electric options are supplied separately and substitute the series fitting.

- Minima altezza di ingombro dell'apparecchio (le quote minime del vano di incasso sono riportate sul foglio di istruzioni)

Minimum height of the appliance (see the minimum values for housing compartment in the instruction sheets)

- \* Dimensione dell'alimentatore maggiore del foro d'incasso, dunque installare l'alimentatore in apposito vano d'ispezione.

Power supply unit is larger than the recess hole, install the power supply unit in a special inspection compartment.

REGISTERED DESIGN

**XGR1021**

XM3 lampholder with terminal block max 50W GU10

IP20

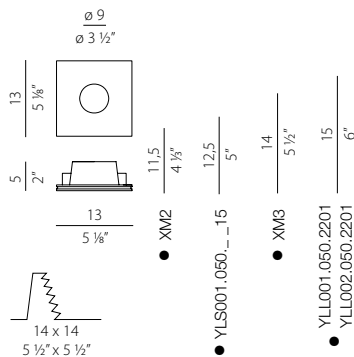
**+ Electric options**

(see details on page 188)

## LAMP

YLL001.050.2201 retrofit lamp  
 YLL002.050.2201 retrofit lamp  
 YLS001.050.\_.15 spot LED  
 XM2 lampholder with terminal block

## DRIVER

XM6-15 UNI  
 XM6-20 UNI ★  
 XM6-20 D/P MULTI ★  
 XM6-25 D/P MULTI

0,42

**XM1021 140x140x155mm**

Cassaforma per incasso in muratura in lamiera zincata.

**Gruppo di alimentazione da prevedere remoto esternamente alla cassaforma.**

Galvanized sheet housing to be recessed in brick wall or concrete.

**Electrical power supply must be remote outside of the housing.**

0,79

- Minima altezza di ingombro dell'apparecchio (le quote minime del vano di incasso sono riportate sul foglio di istruzioni) Minimum height of the appliance (see the minimum values for housing compartment in the instruction sheets)
- ★ Dimensione dell'alimentatore maggiore del foro d'incasso, dunque installare l'alimentatore in apposito vano d'ispezione. Power supply unit is larger than the recess hole, install the power supply unit in a special inspection compartment.



## STEP BY STEP



Apparecchio wall washer in gesso con LED integrato di piccole dimensioni.

Small plaster wall washer with LED.



REGISTERED DESIGN

### XGR1023

Potenza assorbita apparecchio / Luminaire power consumption 1W  
Flusso luminoso apparecchio / Luminaire luminous flux 54lm  
3000K Ra>80 350mA DC

LED IP20

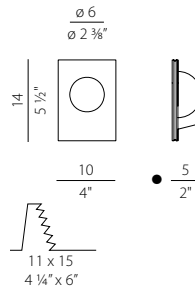

**+ Electric options**  
(see details on page 188)

DRIVER  
XM6-15 UNI ★  
XM6-20 UNI ★  
XM6-20 D/P MULTI ★  
XM6-25 D/P MULTI ★

kg

0,40

### XM1023/1026 149x108x60mm

Cassaforma per incasso in muratura in lamiera zincata.

**Gruppo di alimentazione da prevedere remoto esternamente alla cassaforma.**

Galvanized sheet housing to be recessed in brick wall or concrete.

**Electrical power supply must be remote outside of the housing.**

0,35



REGISTERED DESIGN

### XGR1024

Potenza assorbita apparecchio / Luminaire power consumption 1W  
Flusso luminoso apparecchio / Luminaire luminous flux 54lm  
3000K Ra>80 350mA DC

LED IP20

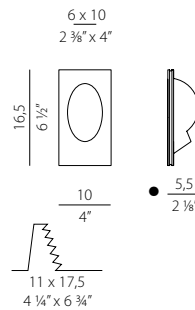

**+ Electric options**  
(see details on page 188)

DRIVER  
XM6-15 UNI ★  
XM6-20 UNI ★  
XM6-20 D/P MULTI ★  
XM6-25 D/P MULTI ★

0,49

### XM1024 173x108x60mm

Cassaforma per incasso in muratura in lamiera zincata.

**Gruppo di alimentazione da prevedere remoto esternamente alla cassaforma.**

Galvanized sheet housing to be recessed in brick wall or concrete.

**Electrical power supply must be remote outside of the housing.**

0,39

- Minima altezza di ingombro dell'apparecchio (le quote minime del vano di incasso sono riportate sul foglio di istruzioni)
- ★ Dimensione dell'alimentatore maggiore del foro d'incasso, dunque installare l'alimentatore in apposito vano d'ispezione.

Minimum height of the appliance (see the minimum values for housing compartment in the instruction sheets)

Power supply unit is larger than the recess hole, install the power supply unit in a special inspection compartment.

**XGQ1025**

Potenza assorbita apparecchio / Luminaire power consumption 1W  
Flusso luminoso apparecchio / Luminaire luminous flux 54lm  
3000K Ra>80 350mA DC

**IP20**

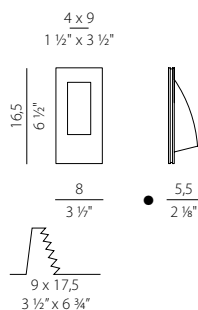

**+ Electric options**  
(see details on page 188)

DRIVER  
XM6-15 UNI ★  
XM6-20 UNI ★  
XM6-20 D/P MULTI ★  
XM6-25 D/P MULTI ★

**XM1025** 171x90x60mm

Cassaforma per incasso in muratura in lamiera zincata.

**Gruppo di alimentazione da prevedere remoto esternamente alla cassaforma.**

Galvanized sheet housing to be recessed in brick wall or concrete.

**Electrical power supply must be remote outside of the housing.**

0,35

**XGQ1026**

Potenza assorbita apparecchio / Luminaire power consumption 1W  
Flusso luminoso apparecchio / Luminaire luminous flux 54lm  
3000K Ra>80 350mA DC

**IP20**

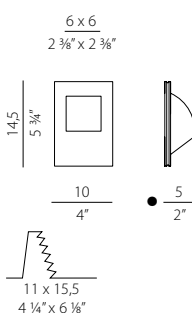

**+ Electric options**  
(see details on page 188)

DRIVER  
XM6-15 UNI ★  
XM6-20 UNI ★  
XM6-20 D/P MULTI ★  
XM6-25 D/P MULTI ★

0,40

**XM1023/1026** 149x108x60mm

Cassaforma per incasso in muratura in lamiera zincata.

**Gruppo di alimentazione da prevedere remoto esternamente alla cassaforma.**

Galvanized sheet housing to be recessed in brick wall or concrete.

**Electrical power supply must be remote outside of the housing.**

0,35

- Minima altezza di ingombro dell'apparecchio (le quote minime del vano di incasso sono riportate sul foglio di istruzioni) Minimum height of the appliance (see the minimum values for housing compartment in the instruction sheets)
- ★ Dimensione dell'alimentatore maggiore del foro d'incasso, dunque installare l'alimentatore in apposito vano d'ispezione. Power supply unit is larger than the recess hole, install the power supply unit in a special inspection compartment.

Fotometrie disponibili [www.panzeri.it](http://www.panzeri.it) / Photometric data available at [www.panzeri.it](http://www.panzeri.it)

**CODICI COLORI DISPONIBILI / COLOUR CODES AVAILABLE**

**42** gesso  
plaster



MOAI



Wall washer in gesso predisposto per la rasatura totale, con sorgente luminosa LED arretrata.

Plaster wall washer prepared for total flush, with recessed LED light source.

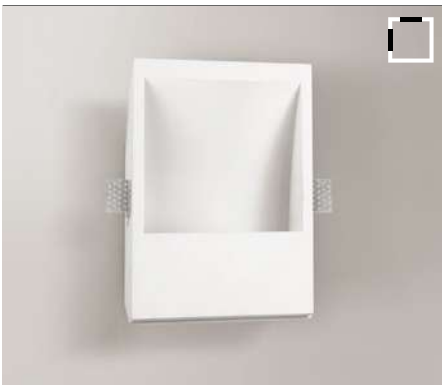

**XGQ1210.0401**

Potenza assorbita apparecchio / Luminaire power consumption 15W  
Flusso luminoso apparecchio / Luminaire luminous flux 1063lm  
3000K Ra>90 220-240V AC ON-OFF

**XGQ1210.0402**

Potenza assorbita apparecchio / Luminaire power consumption 15W  
Flusso luminoso apparecchio / Luminaire luminous flux 1063lm  
3000K Ra>90 220-240V AC dimmable (DALI/Push DIM)

**LED IP20**

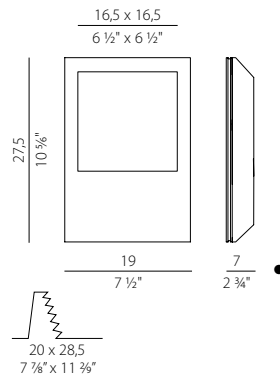

kg

2,01

2,01

**XM1210 325x195x75mm**

Cassaforma per incasso in muratura in lamiera zincata.  
Galvanized sheet housing to be recessed in brick wall or concrete.

1,00

- Minima altezza di ingombro dell'apparecchio (le quote minime del vano di incasso sono riportate sul foglio di istruzioni)
- Minimum height of the appliance (see the minimum values for housing compartment in the instruction sheets)

Fotometrie disponibili [www.panzeri.it](http://www.panzeri.it) / Photometric data available at [www.panzeri.it](http://www.panzeri.it)

**CODICI COLORI DISPONIBILI / COLOUR CODES AVAILABLE**

**42** gesso  
plaster

**21** foglia oro (a richiesta)  
gold leaf (available on request)





# EDDIE



Piccolo faretto in alluminio ad emissione diretta per installazione ad incasso in ambienti interni. Diametro 30mm, sottilissima cornice a vista, sorgente luminosa arretrata. Disponibile in finitura bianco o nero.

Small direct-emitting aluminium spotlight for recessed indoor installations. Diameter 30 mm, recessed light source, very thin visible frame. Available in white or black finishes.



**XR17201.030.1715**

**XR17202.030.1715**

Potenza assorbita apparecchio / Luminaire power consumption 2,1W  
Flusso luminoso apparecchio / Luminaire luminous flux 180lm  
2700K Ra>90 25° 700mA DC

**IP20**

**XR17201.030.2515**

**XR17202.030.2515**

Potenza assorbita apparecchio / Luminaire power consumption 2,1W  
Flusso luminoso apparecchio / Luminaire luminous flux 180lm  
3000K Ra>90 25° 700mA DC

**IP20**

**+ Electric options**  
(see details on page 188)

**DRIVER**  
YDA.070.012.A01 ★  
YDR.090.013.A02 ★

kg

0,05

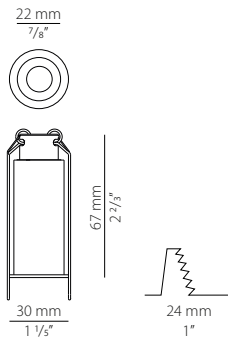

0,05

★ Dimensione dell'alimentatore maggiore del foro d'incasso, dunque installare l'alimentatore in apposito vano d'ispezione.

Power supply unit is larger than the recess hole, install the power supply unit in a special inspection compartment.

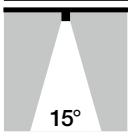

**YLN17200.15**

Lente per fascio stretto.  
Spot optic

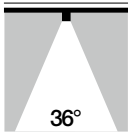

**YLN17200.36**

Lente per fascio medio.  
Flood optic.

Fotometrie disponibili [www.panzeri.it](http://www.panzeri.it) / Photometric data available at [www.panzeri.it](http://www.panzeri.it)

**CODICI COLORI DISPONIBILI / COLOUR CODES AVAILABLE**

**01** bianco  
white

**02** nero  
black







# JAMES



Faretto ad incasso ad emissione diretta con fascio 24° in alluminio pressofuso per ambienti interni con controsoffitto. Sorgente luminosa arretrata con possibilità di orientamento del fascio di luce, fino ad un angolo massimo di 30°. Grado di protezione IP44, impermeabile agli schizzi. Disponibile in finitura bianco o nero.

Die-casted aluminium recessed spotlight with direct emission and 24° beam angle, for indoor application in false ceiling. Recessed light source with the possibility of orienting the light beam up to a maximum angle of 30°. IP44 protection degree, splash-proof. Available in white or black finishes.

kg



**XR17701.040.1715**

**XR17702.040.1715**

Potenza assorbita apparecchio / Luminaire power consumption 5,2W  
Flusso luminoso apparecchio / Luminaire luminous flux 465lm  
2700K Ra>90 24° 300mA DC

**IP44**

**XR17701.040.2515**

**XR17702.040.2515**

Potenza assorbita apparecchio / Luminaire power consumption 5,2W  
Flusso luminoso apparecchio / Luminaire luminous flux 465lm  
3000K Ra>90 24° 300mA DC

**IP44**

### + Electric options

(see details on page 188)

#### DRIVER

YDR.035.008.A01

YDR.035.008.A02

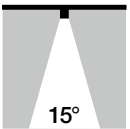
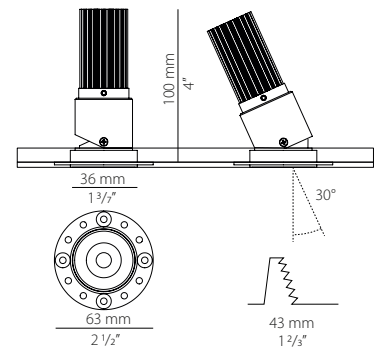

**YLN17700.15**

Lente per fascio stretto.  
Spot optic.

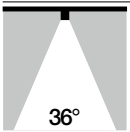

**YLN17700.36**

Lente per fascio medio.  
Flood optic.



**YGA17700.23**

Griglia anti-abbagliamento in colore nero.  
Anti-glare grid in black colour.

Fotometrie disponibili [www.panzeri.it](http://www.panzeri.it) / Photometric data available at [www.panzeri.it](http://www.panzeri.it)

### CODICI COLORI DISPONIBILI / COLOUR CODES AVAILABLE

**01** bianco  
white

**02** nero  
black



# JARVIS



Faretti in alluminio per installazione incassata con cornice a vista ed emissione simmetrica, oppure per incasso a scomparsa con fascio orientabile.  
Disponibili con finitura interna bianca o nera satinata, con o senza sorgente LED GU10. Possibilità di installare sorgente spot LED.

Aluminium downlights for recessed use with visible frame and symmetric light emission, or fully recessed with adjustable beam.  
Inside part available in white or mat black, with or without GU10 LED lamp. Spot LED available.



**XR13001.070.2201**  
**XR13006.070.2201**  
XM3 lampholder with terminal block max 10W GU10  
LED retrofit bulb 7,5W GU10 3000K 60° Ra80 608lm (no dimming)  
Lampadina inclusa / Included bulb

IP20

**XR13001.070.0000**  
**XR13006.070.0000**  
XM3 lampholder with terminal block max 10W GU10  
senza lampadina /  
without bulb

IP20

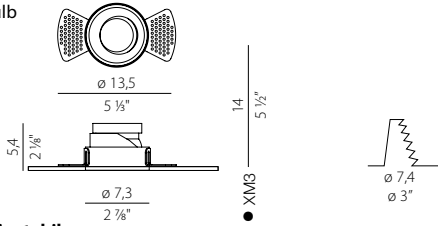

**Faretto orientabile**  
**Adjustable spot**



**+ Electric options**  
(see details on page 188)

LAMP  
YLS002.050.\_\_15 spot LED  
XM2 lampholder with terminal block  
  
DRIVER  
XM6-20 UNI  
YDR.035.012.A02

kg  
0,19

0,15



**XR13101.085.2201**  
**XR13106.085.2201**  
XM3 lampholder with terminal block max 10W GU10  
LED retrofit bulb 7,5W GU10 3000K 60° Ra80 608lm (no dimming)  
Lampadina inclusa / Included bulb

IP20

**XR13101.085.0000**  
**XR13106.085.0000**  
XM3 lampholder with terminal block max 10W GU10  
senza lampadina /  
without bulb

IP20

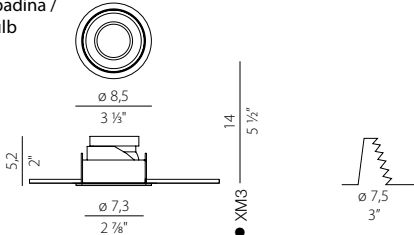

**Faretto fisso**  
**Fixed spot**



**+ Electric options**  
(see details on page 188)

LAMP  
YLS002.050.\_\_15 spot LED  
XM2 lampholder with terminal block  
  
DRIVER  
XM6-20 UNI  
YDR.035.012.A02

0,17

0,13



● Minima altezza di ingombro dell'apparecchio (le quote minime del vano di incasso sono riportate sul foglio di istruzioni) Minimum height of the appliance (see the minimum values for housing compartment in the instruction sheets)

Fotometrie disponibili [www.panzeri.it](http://www.panzeri.it) / Photometric data available at [www.panzeri.it](http://www.panzeri.it)

CODICI COLORI DISPONIBILI / COLOUR CODES AVAILABLE

01 bianco  
white

06 nero satinato  
mat black



# JESSIE



Faretto ad incasso ad emissione diretta con fascio 24° in alluminio pressofuso per ambienti interni. La struttura si presta per l'installazione in controsoffitti con altezze ridotte, min. 70mm (2,8"). Sorgente luminosa arretrata. Disponibile in finitura bianco o nero.

Die-casted aluminium recessed spotlight with direct emission and 24° beam angle, for indoor application. The structure lends itself to installations in low false ceiling heights, min. 70mm (2,8"). Recessed light source. Available in white or black finishes.

kg



**XR17401.040.1715**

**XR17402.040.1715**

Potenza assorbita apparecchio / Luminaire power consumption 5,2W  
Flusso luminoso apparecchio / Luminaire luminous flux 465lm  
2700K Ra>90 24° 300mA DC

IP20

**XR17401.040.2515**

**XR17402.040.2515**

Potenza assorbita apparecchio / Luminaire power consumption 5,2W  
Flusso luminoso apparecchio / Luminaire luminous flux 465lm  
3000K Ra>90 24° 300mA DC

IP20

### + Electric options

(see details on page 188)

#### DRIVER

YDR.035.008.A01

YDR.035.008.A02

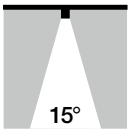
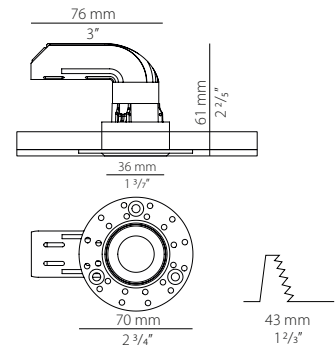

**YLN17400.15**

Lente per fascio stretto.  
Spot optic.

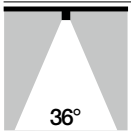

**YLN17400.36**

Lente per fascio medio.  
Flood optic..



**YGA17702.23**

Griglia anti-abbagliamento in colore nero.  
Anti-glare grid in black colour.

Fotometrie disponibili [www.panzeri.it](http://www.panzeri.it) / Photometric data available at [www.panzeri.it](http://www.panzeri.it)

### CODICI COLORI DISPONIBILI / COLOUR CODES AVAILABLE

**01** bianco  
white

**02** nero  
black



# NICK



Incasso rotondo in pressofusione di alluminio a dissipazione passiva con LED COB integrato in colore bianco. A richiesta riflettori con diverse aperture del fascio luminoso.

Round recessed spotlight in die-cast aluminium with passive thermal dissipation equipped with integrated LED COB finished in white colour. On request optics with different light beams.



### XR25401.040.1715

Potenza assorbita apparecchio / Luminaire power consumption 3W  
Flusso luminoso apparecchio / Luminaire luminous flux 153lm  
2700K Ra>90 30° 700mA DC

**+ Electric options**  
(see details on page 188)

kg  
0,10

### XR25401.040.2515

Potenza assorbita apparecchio / Luminaire power consumption 3W  
Flusso luminoso apparecchio / Luminaire luminous flux 170lm  
3000K Ra>90 30° 700mA DC

DRIVER  
XM6-20 UNI ★  
XM6-20 D/P MULTI ★

0,10

**LED IP43 IP20 IK07 850°**

Protezione contro l'inversione di polarità  
Reverse polarity protection

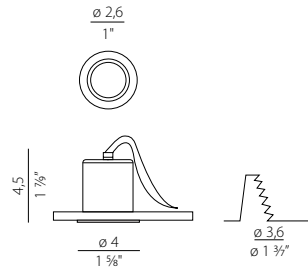

### XR22501.050.1715

Potenza assorbita apparecchio / Luminaire power consumption 6,5W  
Flusso luminoso apparecchio / Luminaire luminous flux 434lm  
2700K Ra>90 26° 700mA DC

**+ Electric options**  
(see details on page 188)

0,10

### XR22501.050.2515

Potenza assorbita apparecchio / Luminaire power consumption 6,5W  
Flusso luminoso apparecchio / Luminaire luminous flux 455lm  
3000K Ra>90 26° 700mA DC

DRIVER  
XM6-20 UNI ★  
XM6-20 D/P MULTI ★  
XM6-25 D/P MULTI ★

0,10

**LED IP65 IP20 IK08 850°**

Protezione contro l'inversione di polarità  
Reverse polarity protection

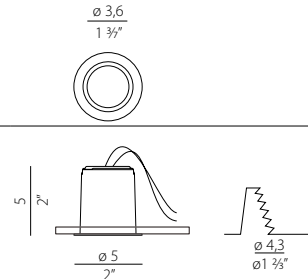

I Driver non sono inclusi, vedi electric options.  
Da acquistare separatamente.

Drivers not included, see electric options.  
Please purchase separately.

★ Dimensione dell'alimentatore maggiore del foro d'incasso, dunque installare l'alimentatore in apposito vano d'ispezione.

Power supply unit is larger than the recess hole, install the power supply unit in a special inspection compartment.

kg

**XR26201.060.1715**

Potenza assorbita apparecchio / Luminaire power consumption 9W/12W  
Flusso luminoso apparecchio / Luminaire luminous flux 609lm/830lm  
2700K Ra>90 38° 250/350mA DC

**+ Electric options**  
(see details on page 188)



0,30

**XR26201.060.2515**

Potenza assorbita apparecchio / Luminaire power consumption 9W/12W  
Flusso luminoso apparecchio / Luminaire luminous flux 632lm/852lm  
3000K Ra>90 38° 250/350mA DC

**DRIVER**  
XM6-15 UNI  
XM6-20 UNI  
XM6-20 D/P MULTI  
XM6-25 D/P MULTI

0,30

 **IP43 IP20 IK08 850° **

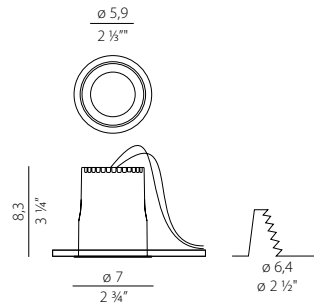

Protezione contro l'inversione di polarità  
Reverse polarity protection

I Driver non sono inclusi, vedi electric options. Da acquistare separatamente.  
Drivers not included, see electric options.  
Please purchase separately.

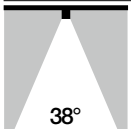
**STANDARD**

Ottica per fascio medio.  
Flood optic.

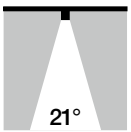
**XMR5**

Ottica per fascio stretto.  
Spot optic.

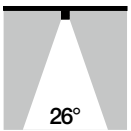
**XMR6**

Ottica per fascio medio.  
Flood optic.

**XMR9**

Cilindro interno colore oro satinato.  
Internal satin gold cylinder.

Fotometrie disponibili [www.panzeri.it](http://www.panzeri.it) / Photometric data available at [www.panzeri.it](http://www.panzeri.it)

**CODICI COLORI DISPONIBILI / COLOUR CODES AVAILABLE**

**01** bianco  
white



# RALLY TRIM



Serie di incassi rettangolari ad emissione diretta con cornice in alluminio pressofuso per ambienti interni, disponibile in tre versioni con lunghezze differenti, in finitura bianca con ottiche nere. La sorgente luminosa arretrata è costituita da moduli LED accoppiati a lenti con fascio di 30°.

Series of rectangular direct-emitting die-casted aluminium downlights with frame for indoor application, available in three versions with different lengths, in white finish with black optics. The recessed light source is made of LED modules coupled with lenses with 30° beam angle.

kg



### XR17801.007.1715

Potenza assorbita apparecchio / Luminaire power consumption 3,6W  
Flusso luminoso apparecchio / Luminaire luminous flux 240lm  
2700K Ra>90 30° 600mA DC

LED IP20

### XR17801.007.2515

Potenza assorbita apparecchio / Luminaire power consumption 3,6W  
Flusso luminoso apparecchio / Luminaire luminous flux 240lm  
3000K Ra>90 30° 600mA DC

LED IP20

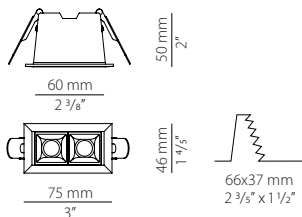

**+ Electric options**  
(see details on page 188)

DRIVER  
XM6-20 UNI  
XM6-20 D/P MULTI  
YDR.090.013.A02

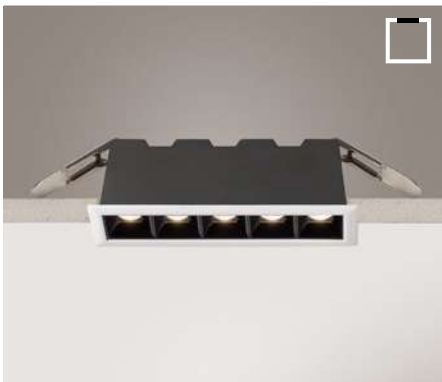

### XR17801.014.1715

Potenza assorbita apparecchio / Luminaire power consumption 9W  
Flusso luminoso apparecchio / Luminaire luminous flux 602lm  
2700K Ra>90 30° 600mA DC

LED IP20

### XR17801.014.2515

Potenza assorbita apparecchio / Luminaire power consumption 9W  
Flusso luminoso apparecchio / Luminaire luminous flux 602lm  
3000K Ra>90 30° 600mA DC

LED IP20

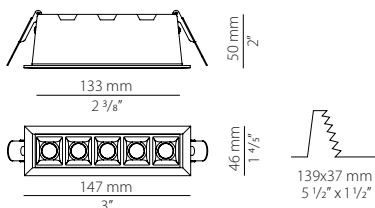

**+ Electric options**  
(see details on page 188)

DRIVER  
XM6-20 UNI  
XM6-20 D/P MULTI  
YDR.090.013.A02

**XR17801.028.1715**

Potenza assorbita apparecchio / Luminaire power consumption 18W  
 Flusso luminoso apparecchio / Luminaire luminous flux 1204lm  
 2700K Ra>90 30° 600mA DC

 **IP20** 

**XR17801.028.2515**

Potenza assorbita apparecchio / Luminaire power consumption 18W  
 Flusso luminoso apparecchio / Luminaire luminous flux 1204lm  
 3000K Ra>90 30° 600mA DC

 **IP20** 

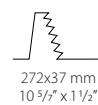
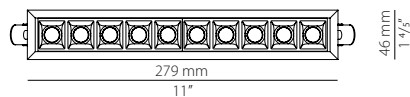
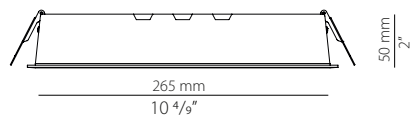

**+ Electric options**  
 (see details on page 188)

DRIVER  
 XM6-20 UNI  
 XM6-20 D/P MULTI  
 XM6-25 D/P MULTI

Fotometrie disponibili [www.panzeri.it](http://www.panzeri.it) / Photometric data available at [www.panzeri.it](http://www.panzeri.it)

**CODICI COLORI DISPONIBILI / COLOUR CODES AVAILABLE**

**01** bianco  
 white





# SID



Piccolo faretto in alluminio ad emissione diretta per installazione ad incasso in ambienti interni. Diametro 20mm, sottilissima cornice a vista, sorgente luminosa arretrata. Disponibile in finitura bianco o nero.

Small direct-emitting aluminium spotlight for recessed indoor installations. Diameter 20 mm, recessed light source, very thin visible frame. Available in white or black finishes.

kg

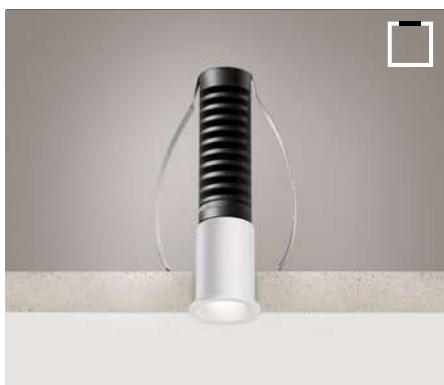

**XR17001.020.1715**

**XR17002.020.1715**

Potenza assorbita apparecchio / Luminaire power consumption 2,1W  
Flusso luminoso apparecchio / Luminaire luminous flux 180lm  
2700K Ra>90 25° 700mA DC

**IP20**

**XR17001.020.2515**

**XR17002.020.2515**

Potenza assorbita apparecchio / Luminaire power consumption 2,1W  
Flusso luminoso apparecchio / Luminaire luminous flux 180lm  
3000K Ra>90 25° 700mA DC

**IP20**

### + Electric options

(see details on page 188)

DRIVER

YDA.070.012.A01 \*

YDR.090.013.A02 \*

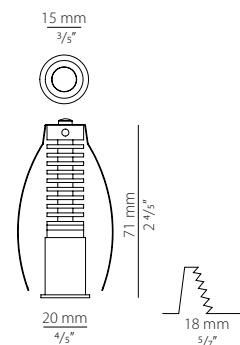

\* Dimensione dell'alimentatore maggiore del foro d'incasso, dunque installare l'alimentatore in apposito vano d'ispezione.

Power supply unit is larger than the recess hole, install the power supply unit in a special inspection compartment.

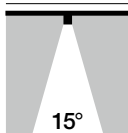

**YLN17000.15**

Lente per fascio stretto.  
Spot optic

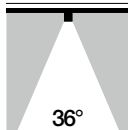

**YLN17000.36**

Lente per fascio medio.  
Flood optic.

Fotometrie disponibili [www.panzeri.it](http://www.panzeri.it) / Photometric data available at [www.panzeri.it](http://www.panzeri.it)

**CODICI COLORI DISPONIBILI / COLOUR CODES AVAILABLE**

**01** bianco  
white

**02** nero  
black







# TAYLOR



Incasso orientabile per interni, equipaggiato con LED COB di ultima generazione. È disponibile in versione a luce calda con accessori ottici intercambiabili, per un'illuminazione sia d'accento che diffusa. La parte mobile rimane nascosta nel controsoffitto. Il design professionale e la cornice sottile disponibile in diverse finiture rendono Taylor la soluzione ideale in progetti di retail, showroom e hospitality. L'ottica è arretrata per un basso livello di abbagliamento, così da garantire un migliore comfort visivo. La profondità di incasso è contenuta e consente una semplice e veloce installazione anche in spazi ristretti. Disponibile nelle finiture bianco, nero, bronzo, ottone satinato e titanio. Driver da acquistare separatamente.

Adjustable downlight for indoors, equipped with COB LED of latest generation. Available in white warm light with optical accessories interchangeable, for a diffused or accent illumination. The adjustable part is hidden within the false ceiling. The professional design and the minimal frame available in different finishes make Taylor the ideal solution for various projects, from retail stores or show-rooms to hospitality. The lens is recessed for low glaring, in order to provide an enhanced visual comfort. The minimal depth of recess allows a simple and quick installation also in false ceilings of limited spaces. Available in finish white, black, bronze, mat brass and titanium. Driver to order separately.

		kg
	<b>X16801.008.2515</b> <b>X16802.008.2515</b> <b>X16817.008.2515</b> <b>X16819.008.2515</b> <b>X16830.008.2515</b> Potenza assorbita apparecchio / Luminaire power consumption 12W Flusso luminoso apparecchio / Luminaire luminous flux 824lm 3000K Ra>90 38° 360mA DC IP43 IP20 IK08 850°	0,40  <b>+ Electric options</b> (see details on page 188)  DRIVER XM6-15 UNI XM6-20 D/P MULTI XM6-25 D/P MULTI  I Driver non sono inclusi, vedi electric options. Da acquistare separatamente. Drivers not included, see electric options. Please purchase separately.

<p><b>38°</b></p>	<b>STANDARD</b> Ottica per fascio medio. Flood optic.
<p><b>21°</b></p>	<b>XMR5</b> Ottica per fascio stretto. Spot optic.
<p><b>44°</b></p>	<b>XMR8</b> Ottica per fascio largo. Wide flood optic.

Fotometrie disponibili [www.panzeri.it](http://www.panzeri.it) / Photometric data available at [www.panzeri.it](http://www.panzeri.it)

**CODICI COLORI DISPONIBILI / COLOUR CODES AVAILABLE**

<b>01</b> bianco white	<b>02</b> nero black	<b>17</b> bronzo bronze	<b>19</b> ottone satinato mat brass	<b>30</b> titanio titanium
---------------------------	-------------------------	----------------------------	--	-------------------------------





JOE



Faretto da incasso in alluminio, bianco o nero con o senza sorgente GU10 LED Spot.

Aluminium recessed spotlight in white or black colour with or without GU10 LED Spot lamp.



**XA2115**

**XA2115 BLA**

XM3 lampholder with terminal block max 50W GU10  
LED retrofit bulb 7,5W GU10 3000K 60° Ra80 608lm (no dimming) \*  
IP20

**ST.XA2115**

**ST.XA2115 BLA**

XM3 lampholder with terminal block max 50W GU10  
senza lampadina  
without bulb

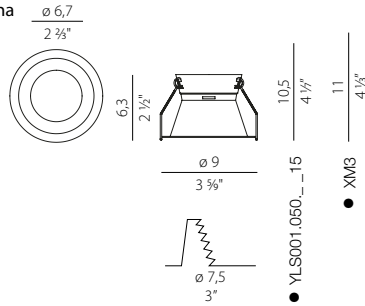

\* Lampadina inclusa / Included bulb

kg

0,09



0,09

**+ Electric options**

(see details on page 188)

LAMP

YLS001.050.\_15 spot LED

DRIVER

XM6-15 UNI

XM6-20 UNI

XM6-20 D/P MULTI

XM6-25 D/P MULTI



**XA2116**

**XA2116 BLA**

XM3 lampholder with terminal block max 50W GU10  
LED retrofit bulb 7,5W GU10 3000K 60° Ra80 608lm (no dimming) \*  
IP20

**ST.XA2116**

**ST.XA2116 BLA**

XM3 lampholder with terminal block max 50W GU10  
senza lampadina  
without bulb

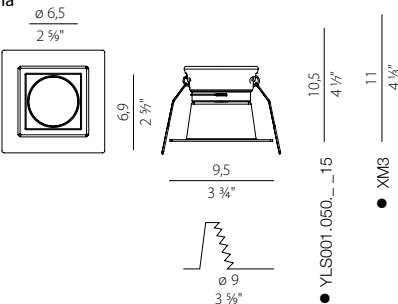

\* Lampadina inclusa / Included bulb

0,12



0,12

**+ Electric options**

(see details on page 188)

LAMP

YLS001.050.\_15 spot LED

DRIVER

XM6-15 UNI

XM6-20 UNI

XM6-20 D/P MULTI

XM6-25 D/P MULTI

● Minima altezza di ingombro dell'apparecchio (le quote minime del vano di incasso sono riportate sul foglio di istruzioni)

Minimum height of the appliance (see the minimum values for housing compartment in the instruction sheets)

Fotometrie disponibili [www.panzeri.it](http://www.panzeri.it) / Photometric data available at [www.panzeri.it](http://www.panzeri.it)

**CODICI COLORI DISPONIBILI / COLOUR CODES AVAILABLE**

bianco  
white

**BLA** nero  
black

## LED PANEL

186 JERSEY

# LED PANEL

## JERSEY



Pannello LED di dimensione 595x595mm con spessore ridotto ed elevata efficienza luminosa, disponibile per luce in tonalità bianco naturale. L'innovativa ottica in PMMA del diffusore è adatta all'utilizzo in uffici con videotermini e permette un illuminamento omogeneo, creando un ambiente confortevole. Versione base installabile in appoggio sui traversini dei controsoffitti a pannelli con struttura a vista, oppure incassabile in controsoffitti a struttura nascosta o continui tramite appositi accessori. Cornice per eventuale installazione a plafone da ordinare a parte. Fornito completo di driver ON-OFF oppure con driver dimmerabile DALI. Kit di emergenza acquistabile separatamente.

LED panel in dimension 595x595mm with limited thickness and high luminous efficacy, available in natural white light.

The innovative optic in PMMA of the diffuser makes it suitable for use in workspaces with monitors and allows a homogeneous illumination, creating a comfortable environment. Base version to install onto the modular metal ceiling with visible structure. Accessory available for installation in modular metal ceiling with hidden structure. Frame for installation as a surface mount available as an option. Supplied with a ON-OFF driver or DALI dimming. Emergency kit to order separately.

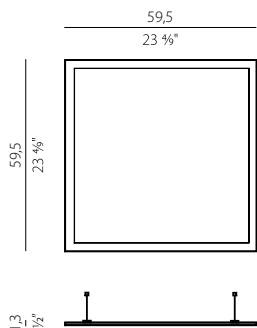

CODICE CODE	FONTI LUMINOSE LIGHT SOURCES	kg
<b>X33547.060.0301</b>	Potenza assorbita apparecchio / Luminaire power consumption 35W Flusso luminoso LED / LED luminous flux 3527lm 4000K Ra>80 220-240V AC ON-OFF <b>IP40 IK05</b>	3,85
<b>X33547.060.0320</b>	Potenza assorbita apparecchio / Luminaire power consumption 35W Flusso luminoso LED / LED luminous flux 3527lm 4000K Ra>80 220-240V AC dimmable DALI <b>IP40 IK05</b>	4,04
<b>XM33500.402.0007</b>	Kit emergenza 3h Emergency kit 3h	
<b>XM33500.201.0099</b>	Kit 4 molle per incasso in battuta su controsoffitti in cartongesso Kit for ceiling mounting in plaster board false ceiling	
<b>XM33500.202.0099</b>	Telaio per montaggio in controsoffitto modulare metallico con struttura nascosta Frame for mounting in modular metal false ceiling with hidden structure	
<b>XM33500.203.0099</b>	Telaio per montaggio in controsoffitto in cartongesso Frame for mounting in plaster board false ceiling	
<b>XM33501.204.0099</b>	Cornice per montaggio a plafone Frame for ceiling mounting	

Fotometrie disponibili [www.panzeri.it](http://www.panzeri.it) / Photometric data available at [www.panzeri.it](http://www.panzeri.it) UGR<19 in funzione delle condizioni di installazione / UGR<19 depending on installation conditions

### CODICI COLORI DISPONIBILI / COLOUR CODES AVAILABLE

<b>01</b> Bianco White	<b>47</b> Bianco + diffusore microprismato White + microprismatic diffusers
---------------------------	--

## **ELECTRIC OPTIONS**

188	ELECTRIC OPTIONS
193	TECHNICAL INFORMATION
196	FONDAMENTI DI ILLUMINOTECNICA / LIGHTING BASICS

## ELECTRIC OPTIONS

### COMPONENTI ELETTRICI / ELECTRICAL COMPONENTS

XM3

LAMPHOLDER + TERMINAL BLOCK

MAX 9W GU10 

IP20  

### LED CORRENTE COSTANTE / LED CONSTANT CURRENT

YLS001.050.1715 (2700K)

YLS001.050.2515 (3000K)

YLS001.050.2915 (4000K)

LED 8,5W 250mA 35V 35° Ra>90

Flusso luminoso apparecchio

Luminaire luminous flux:

2700K - 806lm

3000K - 854lm

4000K - 1053lm



TECHNICAL INFORMATION	WIRING DIAGRAM 4
PAG. 193	PAG. 194

See matrix page 192



YLS002.050.1715 (2700K)

YLS002.050.2515 (3000K)

LED 12W 350mA 35V 36° Ra>90

Flusso luminoso apparecchio

Luminaire luminous flux:

2700K - 1140lm

3000K - 1170lm



TECHNICAL INFORMATION	WIRING DIAGRAM 4
PAG. 193	PAG. 194

See matrix page 192



### LED TENSIONE COSTANTE / LED CONSTANT VOLTAGE

XM006.050.0410

Modulo / module 500 mm 64LED

8,6W 3000K Ra90 24V 1140lm

 62,5mm **2280 lm/m**



TECHNICAL INFORMATION	WIRING DIAGRAM 1
PAG. 193	PAG. 193

See Matrix page 192

500 x 14 mm

19 3/8" x 5/8"



XM006.012.0410

Modulo / module 125 mm 16LED

2,15W 3000K Ra90 24V 285lm

 62,5mm **2280 lm/m**



TECHNICAL INFORMATION	WIRING DIAGRAM 1
PAG. 193	PAG. 193

See Matrix page 192

125 x 14 mm

5" x 5/8"



YLR007.022.0510 (2700K)

YLR007.022.0410 (3000K)

YLR007.022.0610 (4000K)

NEW

STRIP ROLL 5 m 2700/3000/4000K Ra90 24V

 4,2 mm

5 x 240 LED/m - 5 x 22 W/m

5 x **2490 lm/m** (2700K)

5 x **2700 lm/m** (3000K)

5 x **2750 lm/m** (4000K)



TECHNICAL INFORMATION	WIRING DIAGRAM 2
PAG. 193	PAG. 193

See Matrix page 192

5000 x 10 mm

197" x 3/8"



YLR006.017.0510 (2700K)

YLR006.017.0410 (3000K)

YLR006.017.0610 (4000K)

NEW

STRIP ROLL 5 m 2700/3000/4000K Ra90 24V

 5 mm

5 x 200 LED/m - 5 x 16,8 W/m

5 x **1900 lm/m** (2700K)

5 x **2070 lm/m** (3000K)

5 x **2220 lm/m** (4000K)



TECHNICAL INFORMATION	WIRING DIAGRAM 2
PAG. 193	PAG. 193

See Matrix page 192

5000 x 8 mm

197" x 1/2"



YLR005.010.0510 (2700K)

YLR005.010.0410 (3000K)

YLR005.010.0610 (4000K)

NEW

STRIP ROLL 5 m 2700/3000/4000K Ra90 24V

 5 mm

5 x 200 LED/m - 5 x 9,6 W/m

5 x **1100 lm/m** (2700K)

5 x **1220 lm/m** (3000K)

5 x **1300 lm/m** (4000K)



TECHNICAL INFORMATION	WIRING DIAGRAM 2
PAG. 193	PAG. 193

See Matrix page 192

5000 x 8 mm

197" x 1/2"



YLR008.010.0510 (2700K)

YLR008.010.0410 (3000K)

NEW

STRIP ROLL IP67 5 m 2700/3000K Ra90 24V

 5 mm

5 x 200 LED/m - 5 x 9,6 W/m

5 x **1100 lm/m** (2700K)

5 x **1220 lm/m** (3000K)



TECHNICAL INFORMATION	WIRING DIAGRAM 2
PAG. 193	PAG. 193

See Matrix page 192

5000 x 10 mm

197" x 3/8"



## SORGENTI LED / LED LAMP 220-240V

YLL001.050.2201

7,5W GU10 Ø 50 mm 3000K Ra80 680lm 60° 220-240V NOT DIMMABLE



YLL002.050.2201

7,5W GU10 Ø 50 mm 3000K Ra80 680lm 60° 220-240V NOT DIMMABLE



XM5/GU10-35

4W GU10 Ø 35 mm 3000K Ra80 340lm 220-240V NOT DIMMABLE



XM5/G9LED



4W G9 3000K Ra80 330lm 110-240V NOT DIMMABLE



## LED DRIVER CORRENTE COSTANTE / LED DRIVER CONSTANT CURRENT

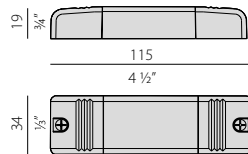

XM6-15 UNI



V in 100-240V AC  
 V out 2-41,5V DC  
 I out 60-360mA  
 W 2,5-15  
 λ 0,80  
  SELV  
 See Matrix page 192

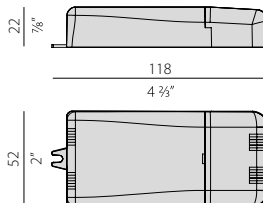

XM6-20 UNI



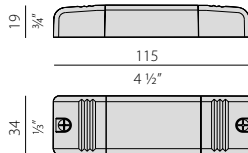

V in 220-240V AC  
 V out 2-54V DC  
 I out 250-700mA  
 W 4-20  
 λ 0,95  
  SELV  
 See Matrix page 192

YDA.070.012.A01

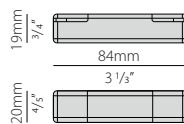

V in 220-240V AC  
 V out 2-16V DC  
 I out 700mA  
 W 12  
 λ 0,85  
  SELV  
 See Matrix page 192

YDR.035.008.A01  
NEW

V in 220-240V AC  
 V out 8-22,5V DC  
 I out 200-350mA  
 W 4,5-7,9  
 λ 0,50  
  SELV  
 See Matrix page 192

## ELECTRIC OPTIONS

### LED DRIVER CORRENTE COSTANTE DIMMERABILE / LED DRIVER DIMMABLE CONSTANT CURRENT

YDR.035.008.A02

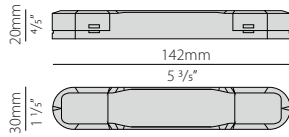

V in 220-240V AC  
 V out 5-42V DC  
 I out 120-350mA  
 W 5-8,4  
 λ 0,95  
 SELV PUSH DIM DALI  
 See Matrix page 192

YDR.035.012.A02

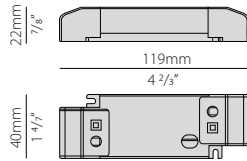

V in 220-240V AC  
 V out 9-42V DC  
 I out 120-350mA  
 W 5-14,7  
 λ 0,95  
 SELV PUSH DIM DALI  
 See Matrix page 192

YDR.050.012.A02

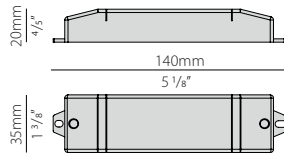

V in 220-240V AC  
 V out 6-40V DC  
 I out 200-500mA  
 W 8-10  
 λ ≥ 0,90  
 SELV PUSH DIM DALI  
 See Matrix page 192

YDR.090.013.A02

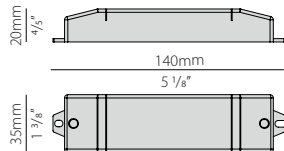

V in 220-240V AC  
 V out 24V DC  
 I out 600-900mA  
 W 9,6-9,9  
 λ ≥ 0,90  
 SELV PUSH DIM DALI  
 See Matrix page 192

XM6-20 D/P MULTI

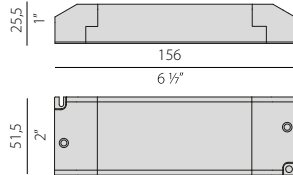

V in 220-240V AC  
 V out 3-46V DC  
 I out 200-900mA  
 W 9,2-28  
 λ ≥ 0,95  
 SELV 1...10V PUSH DIM DALI  
 See Matrix page 192

XM6-25 D/P MULTI

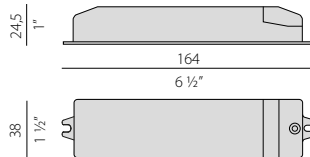

V in 220-240V AC  
 V out 3-55V DC  
 I out 200-900mA  
 W 11-25,6  
 λ ≥ 0,92  
 SELV PUSH DIM DALI  
 See Matrix page 192

### LED DRIVER TENSIONE COSTANTE 48V / LED DRIVER CONSTANT VOLTAGE 48V

YDV.048.075.A01

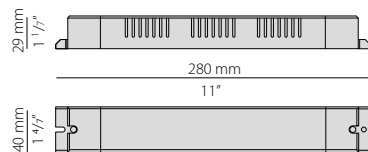

V in 220-240V AC  
 V out 48V DC  
 I out 1,55A DC  
 W 75  
 λ ≥ 0,96  
 SELV

YDV.048.150.A01

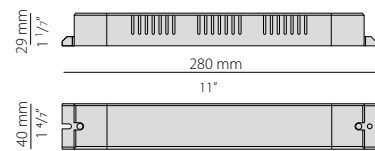

V in 220-240V AC  
 V out 48V DC  
 I out 3,125A DC  
 W 150  
 λ ≥ 0,96  
 SELV



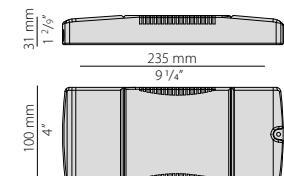







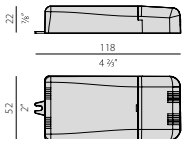

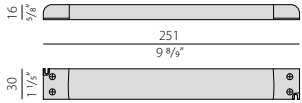

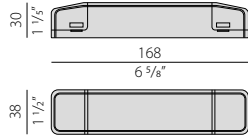

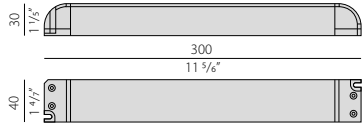

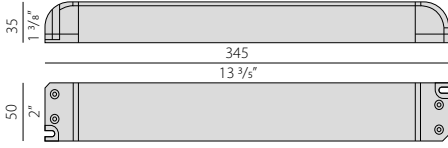

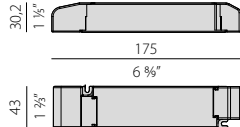
YDV.048.150.A02

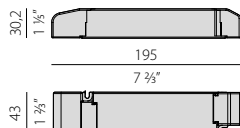

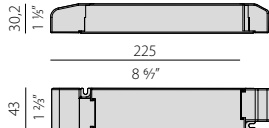
V in 220-240V AC  
 V out 48V DC  
 I out 3,125A DC  
 W 150  
 λ 0,99  
 SELV PUSH DIM DALI

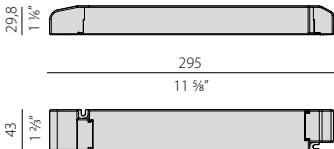

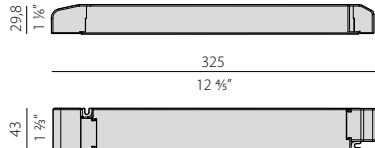
## LED DRIVER TENSIONE COSTANTE 24V / LED DRIVER CONSTANT VOLTAGE 24V

<b>XM6-20 UNI</b>		<p>V in 220-240V AC  V out 24V DC  I out 700mA DC  W 16  λ 0,97</p> <p>  <b>SELV</b></p> <p>See Matrix page 192</p>
<b>YDV.024.030.A01</b>		<p>V in 220-240V AC  V out 24V DC  I out 1,25A DC  W 30  λ ≥ 0,9</p> <p>  <b>SELV</b></p> <p>See Matrix page 192</p>
<b>YDV.024.075.A01</b>		<p>V in 220-240V AC  V out 24V DC  I out 3,13A DC  W 75  λ 0,9</p> <p>  <b>SELV</b></p> <p>See Matrix page 192</p>
<b>YDV.024.120.A01</b>		<p>V in 220-240V AC  V out 24V DC  I out 5A DC  W 120  λ 0,95</p> <p>  <b>SELV</b></p> <p>See Matrix page 192</p>
<b>YDV.024.180.A01</b>		<p>V in 220-240V AC  V out 24V DC  I out 7,5A DC  W 180  λ 0,95</p> <p>  <b>SELV</b></p> <p>See Matrix page 192</p>
<b>XM18/24 DIM</b>		<p>V in 220-240V AC  V out 24V DC  I out 0,75A DC  W 18  λ 0,95</p> <p> <b>SELV PUSH DIM DALI</b></p> <p>See Matrix page 192</p>
<b>XM35/24 DIM</b>		<p>V in 220-240V AC  V out 24V DC  I out 1,453A DC  W 35  λ 0,98</p> <p> <b>SELV PUSH DIM DALI</b></p> <p>See Matrix page 192</p>
<b>XM60/24 DIM</b>		<p>V in 220-240V AC  V out 24V DC  I out 2,50A DC  W 60  λ 0,98</p> <p> <b>SELV PUSH DIM DALI</b></p> <p>See Matrix page 192</p>
<b>XM100/24 DIM</b>		<p>V in 220-240V AC  V out 24V DC  I out 4,167A DC  W 100  λ 0,99</p> <p> <b>SELV PUSH DIM DALI</b></p> <p>See Matrix page 192</p>
<b>XM150/24 DIM</b>		<p>V in 220-240V AC  V out 24V DC  I out 6,250A DC  W 150  λ 0,99</p> <p> <b>SELV PUSH DIM DALI</b></p> <p>See Matrix page 192</p>

## ELECTRIC OPTIONS

### SISTEMI DI CONTROLLO LED / LED CONTROL SYSTEM

Dispositivi per la dimmerazione di moduli LED a 12, 24 e 48V DC. Utilizzabili con alimentatore standard (non dimmerabile). E' possibile applicarli anche in impianti esistenti senza sostituire gli alimentatori già in uso.

Dimming devices for LED modules (12, 24, 48 V DC). Can be used with standard drivers (not dimmable). It's also possible to use the device in existing lighting systems without replacing the already installed drivers.

YCO.C048.A02

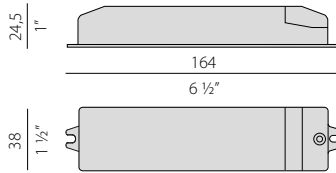

DISPOSITIVO DIMMERABILE / DIMMING DEVICE

Modalità di dimmerazione / Dimming mode:

0-10V, 1-10V, PUSH DIM, DALI

Master, slave

V in 12-48V DC

I out 12A DC

W 12V: 144W - 24V: 288W - 48V: 576W

SELV 0...10V 1...10V PUSH DIM DALI

TECHNICAL INFORMATION	WIRING DIAGRAM 6
PAG. 193	PAG. 195

See Matrix page 192

YCO.D048.A02

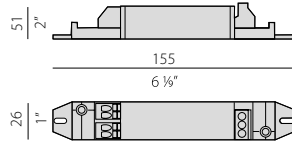

DISPOSITIVO DIMMERABILE / DIMMING DEVICE

Modalità di dimmerazione / Dimming mode:

1-10V, PUSH DIM, DALI

V in 12-48V DC

I out 6A DC

W 12V: 72W - 24V: 144W - 48V: 288W

SELV 1...10V PUSH DIM DALI

TECHNICAL INFORMATION	WIRING DIAGRAM 7
PAG. 193	PAG. 195

See Matrix page 192

### MATRICE LED/DRIVER - LED/DRIVER MATRIX

MODELLO / MODEL	YLS001	YLS002	XM006	YLR005	YLR006	YLR007	YLR008	YLR101	YLR102
<b>Constant current</b>									
XM6-15 UNI	1	1							
XM6-20 UNI	1	1	• (24V setting)	• (24V setting)	• (24V setting)	• (24V setting)	• (24V setting)	• (24V setting)	• (24V setting)
YDA.070.012.A01									
YDR.035.008.A01									
YDR.035.008.A02									
YDR.035.012.A02	1	1							
YDR.050.012.A02	1	1							
YDR.090.013.A02									
XM6-20 D/P MULTI	1	1							
XM6-25 D/P MULTI	1	1							

<b>Constant voltage</b>									
YDV.024.030.A01			•	•	•	•	•	•	•
YDV.024.075.A01			•	•	•	•	•	•	•
YDV.024.120.A01			•	•	•	•	•	•	•
YDV.024.180.A01			•	•	•	•	•	•	•
XM18/24 DIM			•	•	•	•	•	•	•
XM35/24 DIM			•	•	•	•	•	•	•
XM60/24 DIM			•	•	•	•	•	•	•
XM100/24 DIM			•	•	•	•	•	•	•
XM150/24 DIM			•	•	•	•	•	•	•

<b>Led control systems</b>									
YCO.C048.A02			•	•	•	•	•	•	•
YCO.D048.A02			•	•	•	•	•	•	•

APPARECCHI CON LED A TENSIONE COSTANTE 24V DC

Le nostre strip LED sono state studiate per essere installate all'interno dei nostri prodotti: se impiegate in altre situazioni, è necessario dissipare adeguatamente il calore.

Il collegamento tra i vari apparecchi/LED deve essere effettuato in parallelo.

Nella scelta dell'alimentatore, mantenere sempre un margine aggiuntivo del 10% sulla potenza impiegata.

E' necessario considerare la distanza tra alimentatori e apparecchi/LED per limitare possibili cadute di tensione.

La tabella 1(sotto) indica la distanza massima tra alimentatore e gli apparecchi/LED in funzione della sezione del cavo e della potenza, con alimentazione a 24V DC.

FIXTURES USING LEDS WITH A CONSTANT VOLTAGE OF 24V DC

Our LED strips are designed to be installed in our products; if installed elsewhere please consider thermal management by using proper heatsinks.

The connection between the various fixtures / LEDs must be carried out in parallel. Always consider an increase of 10% on the power used defying power supply.

The distance between power supplies and fixtures / LED must be considered to limit possible voltage drop.

Table 1 (below) indicates the maximum distance between the power supply and the luminaires / LEDs according to cable section and power, with 24V DC power supply.

TABELLA 1			
W	1 mm <sup>2</sup>	1,5 mm <sup>2</sup>	2,5 mm <sup>2</sup>
10	56 m	85 m	141 m
20	28 m	42 m	71 m
30	19 m	28 m	47 m
40	14 m	21 m	35 m
50	11 m	17 m	28 m
60	9 m	14 m	24 m
70	8 m	12 m	20 m
80	7 m	11 m	18 m
90	6 m	9 m	16 m
100	6 m	8 m	14 m
110	5 m	8 m	13 m
120	5 m	7 m	12 m
130	4 m	7 m	11 m
140	4 m	6 m	10 m
150	4 m	6 m	9 m

WIRING DIAGRAM NR. 1

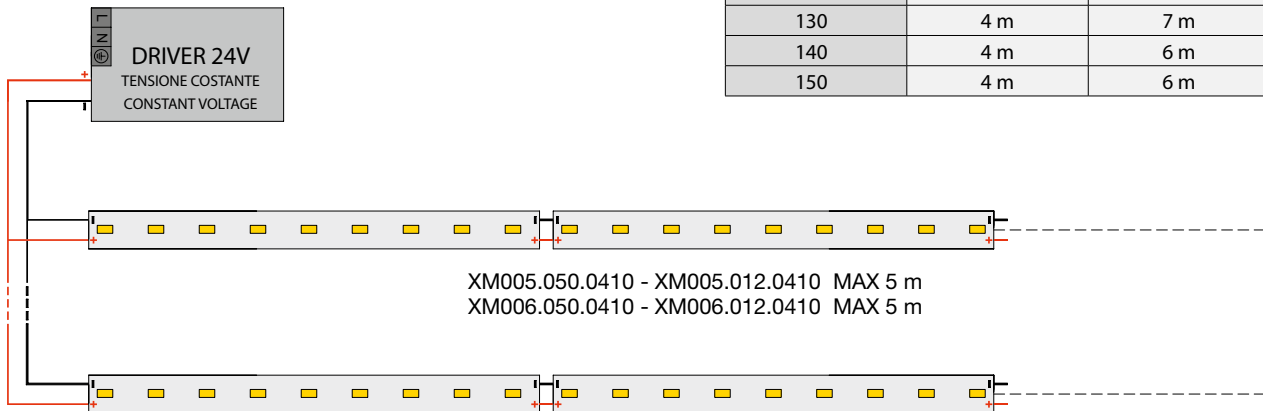

WIRING DIAGRAM NR. 2

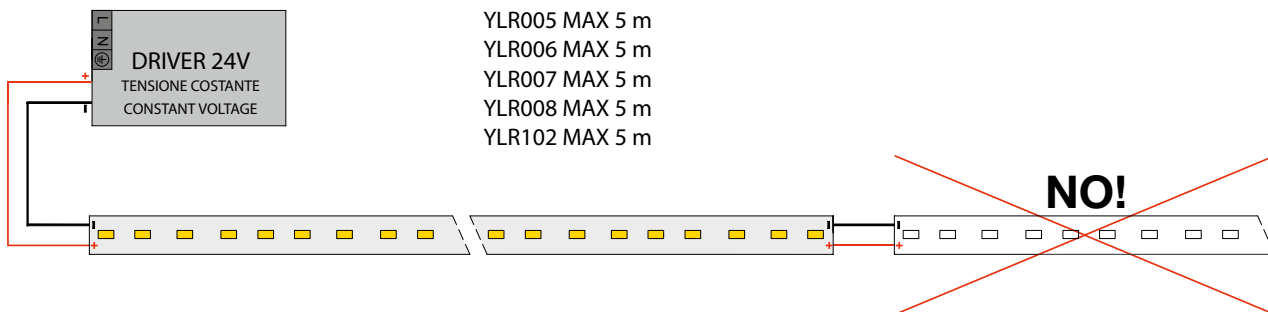

WIRING DIAGRAM NR. 3

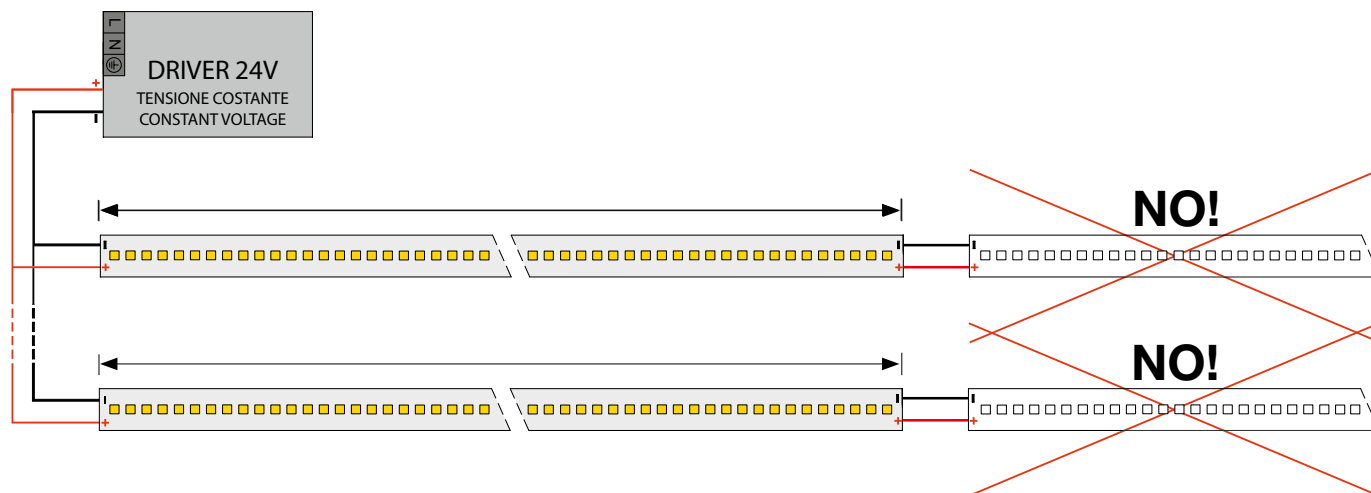

APPARECCHI CON LED A CORRENTE COSTANTE

Il collegamento tra i vari apparecchi/led deve essere effettuato in serie. Il numero di LED per alimentatore dipende dalla potenza e dalla tensione che l'alimentatore rende disponibile. Nonostante l'utilizzo di correnti molto basse è opportuno considerare la distanza tra alimentatori e apparecchi/LED. Segue la tabella 2 che indica la lunghezza/sezione del cavo con alimentazione a corrente costante. Viene indicata la distanza massima tra alimentatore e apparecchi/LED.

FIXTURES USING LEDS WITH A CONSTANT CURRENT

The connection between the various fixtures / LEDs must be carried out in series. The number of LEDs per power supply unit depends on the available power and voltage of the unit. Notwithstanding the use of very low currents, it is advisable to take into consideration the distance between ballasts and fixtures / LEDs. Table 2 (below) indicates the length / section of the cable using a constant current supply. It shows the maximum distance between the power supply and the fixture/LED.

TABELLA 2			
Sezione	1 mm <sup>2</sup>	1,5 mm <sup>2</sup>	2,5 mm <sup>2</sup>
Lunghezza	20 m	30 m	50 m

WIRING DIAGRAM NR. 4

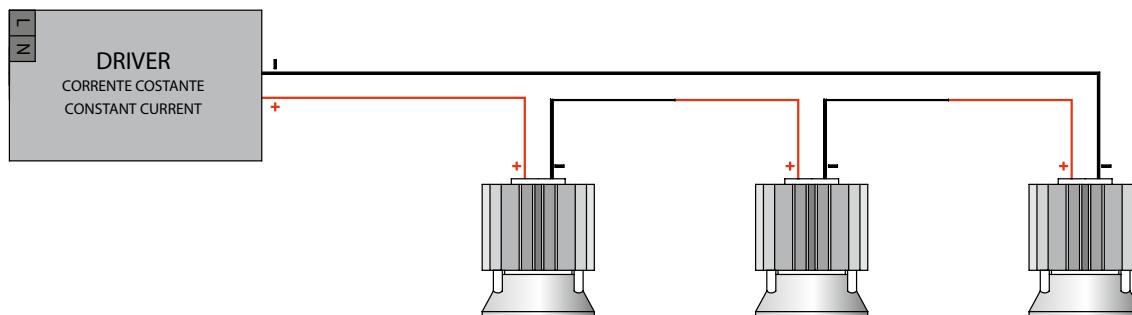

WIRING DIAGRAM NR. 5

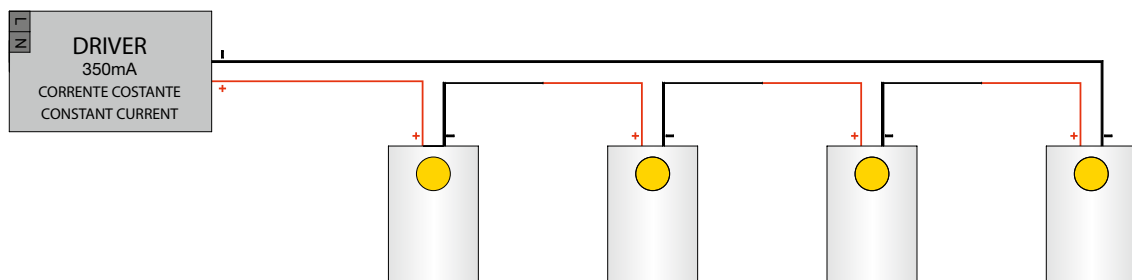

WIRING DIAGRAM NR. 6

YCO.C048.A02

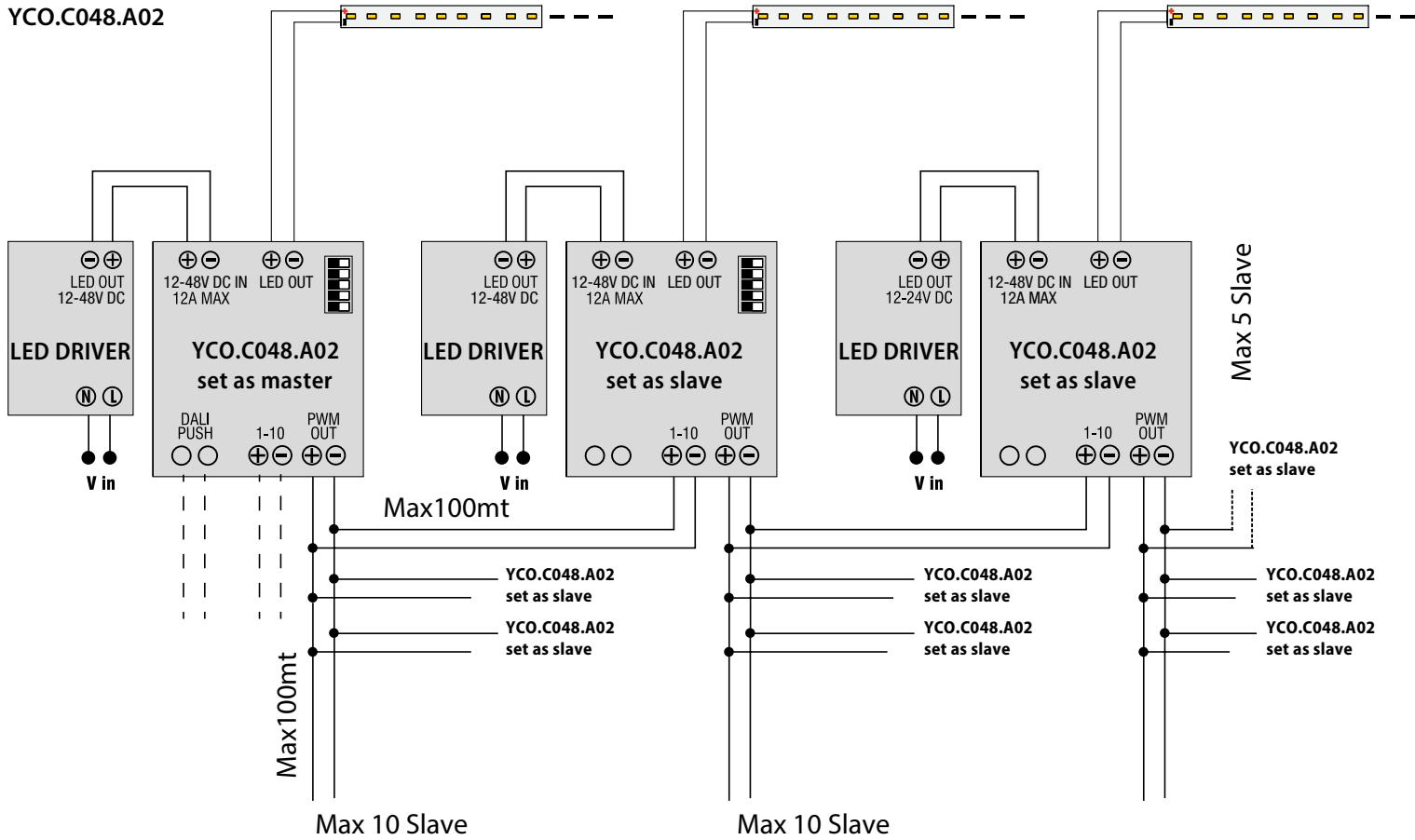

WIRING DIAGRAM NR. 7

YCO.D048.A02

Wiring diagram DALI

Wiring diagram Push

Wiring diagram Trimmer 1/10V

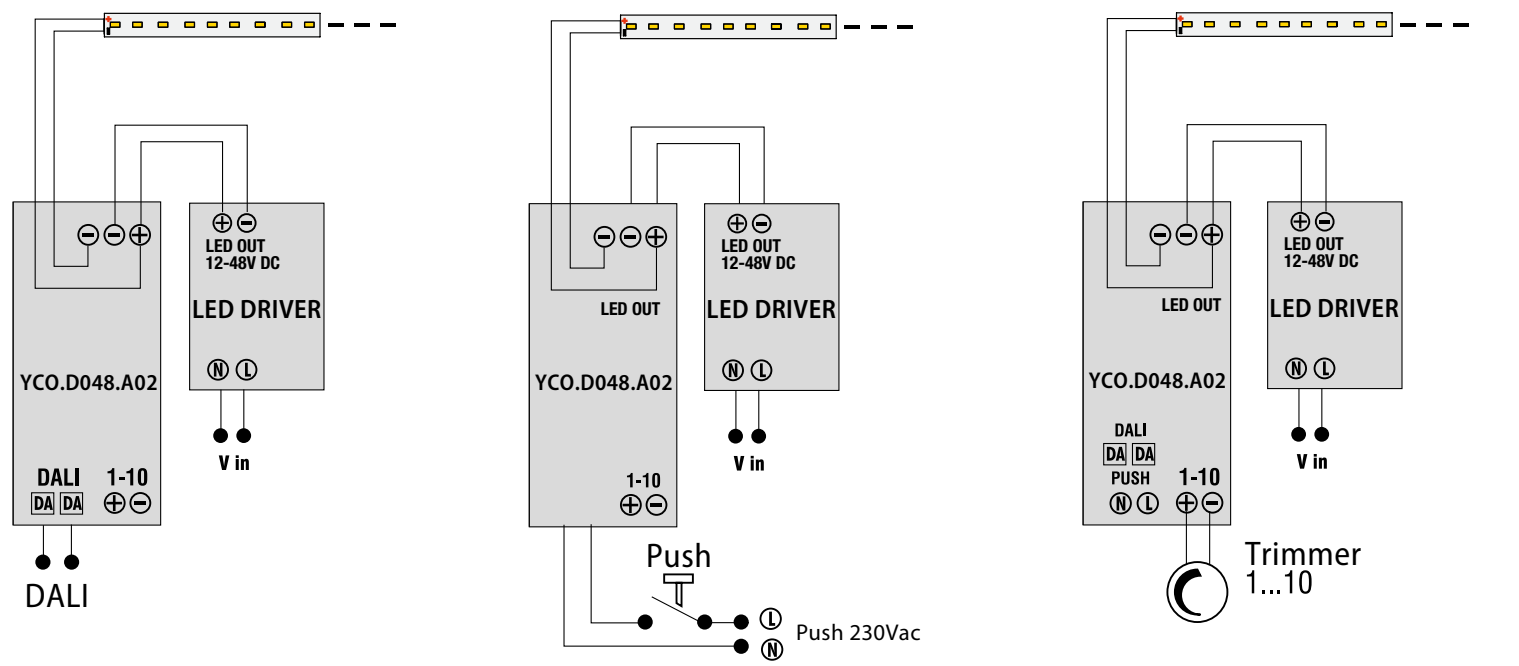

**FLUSSO LUMINOSO  $\Phi$**

Unità di misura: lumen (lm)

Per flusso luminoso si intende l'intera potenza irradiata dalla sorgente luce che viene valutata con la sensibilità spettrale dell'occhio. Il flusso luminoso è una grandezza molto utile per confrontare le lampade tradizionali con i LED.

**LUMINOUS FLUX  $\Phi$**

Unit: lumen (lm)

Luminous flux means the total power radiated by a light source, which is evaluated considering the spectral sensitivity of the eye. The luminous flux is a measurement very useful when comparing traditional lamps with LEDs.

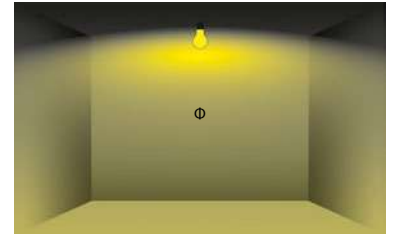

**INTENSITÀ LUMINOSA I**

Unità di misura: candela (cd)

Una sorgente luminosa irradia il suo flusso luminoso generalmente in diverse direzioni con diversa intensità. L'intensità della luce irradiata in una determinata direzione viene definita intensità luminosa.

**LUMINOUS INTENSITY I**

Unit: candela (cd)

A light source emits its luminous flux usually in different directions and at different intensities. The intensity of light radiated in a given direction is defined as light intensity.

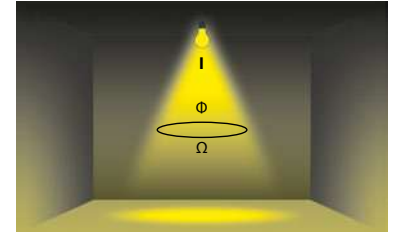

**ILLUMINAMENTO E**

Unità di misura: lux (lx)

L'illuminamento è dato dal rapporto tra il flusso luminoso irradiato e la superficie illuminata. L'illuminamento prodotto da un flusso luminoso di 1 lm che cade in modo uniforme su una superficie di 1 m<sup>2</sup> è pari a 1 lx.

**ILLUMINANCE E**

Unit: lux (lx)

Illuminance is the ratio of the luminous flux and the illuminated surface. The illumination produced by a luminous flux of 1 lm that falls evenly on a surface of 1 square meter is equal to 1 lx.

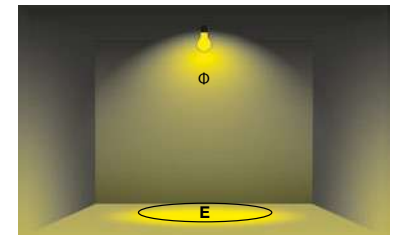

**LUMINANZA L**

Unità di misura: candela per metro quadrato [cd/m<sup>2</sup>]

La luminanza L di una sorgente di luce o di una superficie illuminata è determinante per la sensazione di luce percepita.

**LUMINANCE L**

Unit: candela per square meter [cd/m<sup>2</sup>]

The luminance L of a light source or an illuminated surface indicates how much luminous power will be detected by an eye looking at the surface from a particular angle of view.

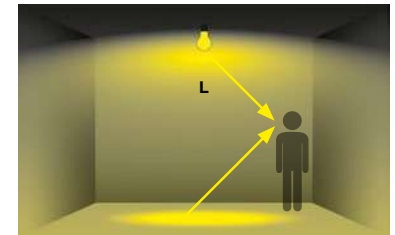

**L'EFFICIENZA LUMINOSA**

Unità di misura: lumen per watt (lm/W)

L'efficienza luminosa indica il rendimento di una lampada.

Viene espressa dal rapporto fra il flusso luminoso prodotto in lumen e la potenza applicata in watt.

**LUMINOUS EFFICACY**

Unit: lumens per watt (lm/W)

Luminous efficacy indicates the efficiency of a lamp. It is the ratio between the luminous flux in lumens produced and the applied power in watts.

**TEMPERATURA DI COLORE**

Unità di misura: kelvin (K)

Temperatura di colore indica la tonalità della luce. Più è alto il valore e più fredda è la tonalità della luce

3000K - tonalità calda

4000K - tonalità neutra

5500K - tonalità diurna

**COLOUR TEMPERATURE**

Unit: kelvin (K)

Colour temperature indicates a light's tonality: the higher the value, the colder the tone of the light

3000K - warm tone

4000K - neutral tone

5500K - daylight tone

**INDICE DI RESA CROMATICA**

Ra oppure in inglese Color Rendering Index (CRI)

Si indica come resa cromatica la fedeltà nella riproduzione dei colori sotto una certa illuminazione.

L'indice massimo di 100 rappresenta la resa cromatica ideale.

**COLOR RENDERING INDEX**

Ra or Color Rendering Index (CRI)

Ra is a quantitative measure of the ability of a light source to reproduce the colors of various objects faithfully in comparison with an ideal or natural light source.

The Ra maximum value 100 equals ideal color rendering.



Prodotto conforme alle norme di sicurezza e alle direttive europee vigenti. **Tutti i prodotti Panzeri sono conformi alle prescrizioni del marchio CE.**  
Product complying with safety rules and EU directives. **All Panzeri's products are compliant with CE mark requirements.**



Apparecchio in classe II  
Apparecchio nel quale la protezione contro la scossa elettrica non si basa unicamente sull'isolamento fondamentale, ma anche sulle misure supplementari di sicurezza costituite dal doppio isolamento o dall'isolamento rinforzato. Queste misure non comportano dispositivi per la messa a terra e non dipendono dalle condizioni di installazione.  
Class II Fixture  
A fixture for which protection against an electric shock does not rely only on basic insulation but also offers further safety measures, such as double insulation or reinforced insulation.  
These measures do not require grounding devices and are not dependent upon installation conditions.



Apparecchio in classe III  
Apparecchio in cui la protezione contro la scossa elettrica si basa sull'alimentazione a bassissima tensione di sicurezza e in cui non si generano tensioni superiori alla stessa.  
Nota: un apparecchio in classe III non deve essere provvisto di messa a terra.  
Class III Fixture  
A fixture in which protection against an electric shock is guaranteed by the extremely low and safe voltage level of the power supply, which does not generate higher voltage levels. NB: a Class III fixture does not require grounding protection.

**IP..**

Grado di protezione  
Il grado di protezione degli apparecchi di illuminazione viene indicato con la sigla "IP" seguita da due cifre caratteristiche.  
- la prima indica la protezione contro la penetrazione dei corpi solidi e della polvere  
- la seconda indica la protezione contro la penetrazione dei liquidi  
Protection Index  
The protection rating of the lighting appliances is shown by the letters "IP" followed by two characteristic digits  
- the first of these two digits indicates the degree of protection that the appliances offer against the entry of solid foreign objects  
- the second one indicates the protection against the entry of water

**IK**

Grado di protezione degli involucri per apparecchiature elettriche contro impatti meccanici esterni (codice IK)  
Degree of protection provided by enclosures for electrical equipment against external mechanical impacts (IK code)



Lampadina protetta contro esplosioni  
Lamp protected against explosion

**RoHS**

RoHS - DIRETTIVA 2002/95/CE (Restriction of the use of certain Hazardous Substances in electrical and electronic equipment) Direttiva europea che limiti l'utilizzo di alcune sostanze pericolose (piombo, cadmio, mercurio, cromo esavalente, bifenile polibromurati, Eteri difendi polibromurati. A partire da 1 luglio 2006 tali sostanze non possono essere più impiegate nei prodotti elettrici ed elettronici, salvo deroghe su alcune applicazioni.  
RoHS - DIRECTIVE 2002/95/CE (Restriction of the use of certain Hazardous Substances in electrical and electronic equipment). The European Directive restricts the use of some dangerous substances: lead, mercury, cadmium, hexavalent chromium, polybrominated biphenyls (PBB) or polybrominated diphenyl ethers (PBDE). From 1st July 2006 such substances shall not be used anymore in electrical and electronic equipment apart from exceptions on specific applications.

**EAC**

Marchio unico di certificazione EAC (EurAsian Certification) che sostituisce i marchi nazionali GOST (R per la Russia, B per Bielorussia e K per Kazakistan)  
Unique brand of EAC certification (Eurasian Certification) which replaces the national GOST brands (R for Russia, B for Belarus and K for Kazakhstan).

**SELV**

Bassissima tensione di sicurezza  
Safety Extra Low Voltage

**1...10V**

Dimmer analogico con segnale di tensione continua 1...10V  
Analogic dimmer with a direct voltage signal



Dimmer a taglio di fase ascendente/discendente (TRIAC)  
Phase cutting dimmer leading edge, trailing edge (TRIAC)

**DALI**

Dimmer digitale con interfaccia DALI  
Digital dimmer with DALI interface

**DALI/PUSH DIM**

Dimmer con funzionalità DALI o pulsante normalmente aperto NA  
Dimmer for DALI protocol or push button application

**PUSH DIM**

Dimmer con pulsante normalmente aperto NA  
Dimmer with push button NO

**STEP DIM**

Step Dim: accensione massima + 3 livelli di dimmerazione + spegnimento tramite sensore touch.  
Step Dim: max on + 3 dimming levels + off through touch sensor.



Alimentatore idoneo al montaggio indipendente  
Independent driver can be mounted separately outside a luminaire

**1H/12H EMERGENCY**

Emergenza integrata. Autonomia 1h / Tempo di ricarica 12h  
Integrated emergency. Duration 1h/Recharging time 12h

**850°**

Prova del filo incandescente a 850°C.  
Glow wire test at 850° degree.

CONSORZIO PER LA RACCOLTA E LO SMALTIMENTO DELLE APPARECCHIATURE DI ILLUMINAZIONE

PANZERI CARLO SRL ADERISCE AL CONSORZIO ECOLIGHT - MILANO ITALY

WEEE - DIRETTIVA 2002/96/CE, 2003/108/CE (WASTE ELECTRICAL AND ELECTRONIC EQUIPMENT) RIFIUTI DI APPARECCHI ELETTRICI ED ELETTRONICI.

La direttiva valida su tutto il territorio dell'Unione Europea definisce una serie di misure allo scopo di prevenire la produzione di rifiuti di apparecchiature elettriche ed elettroniche; di promuovere il riutilizzo, il riciclo ed altre forme di recupero di tali tipologie di rifiuti; di limitare i rischi di impatto sull'ambiente derivanti dal trattamento e dallo smaltimento dei rifiuti in questione; di armonizzare le misure nazionali di gestione dei rifiuti elettrici ed elettronici.

Gli apparecchi di illuminazione marcati con l'apposito simbolo del cassonetto barrato  sono soggetti a raccolta differenziata separata dal resto dei rifiuti urbani.

Per la restituzione di un dispositivo dimesso, occorre servirsi dei sistemi di restituzione e di raccolta messi a disposizione nei singoli paesi di utilizzo.

PANZERI CARLO SRL JOINS CONSORZIO ECOLIGHT - MILANO ITALY

WEEE - DIRECTIVE 2002/96/CE, 2003/108/CE (WASTE ELECTRICAL AND ELECTRONIC EQUIPMENT).

The European Directive is applicable throughout the European Union and determines the measures in order to prevent the production of waste electrical and electronic equipment; to promote the re-use, the recycle and other forms of reutilization of these kind of waste; to restrict the risks of impact to the environment coming from treatment and disposal of these equipments; to harmonize national measures of managing waste electrical and electronic equipment.

Equipment marked with proper symbol of crossed container  may not be disposed of with household rubbish.

To return the used device, the return and collection systems available in every single Country must be used.

Panzeri utilizza energia elettrica prodotta da fonti rinnovabili / Panzeri employs electricity from renewable sources



**ATTESTATO ENERGIA  
ELETTRICA CERTIFICATA**  
CERTIFIED ELECTRICAL ENERGY CERTIFICATE

ADA Energia conferma l'impegno di  
ADA Energy confirms the commitment of  
**PANZERI CARLO SRL**

per contribuire concretamente a salvaguardare l'ambiente  
grazie all'acquisto di titoli GO che garantiscono l'origine da fonti  
rinnovabili dell'energia elettrica utilizzata nel periodo  
to making a concrete contribution to safeguarding the environment thanks  
to the purchase of GO shares that guarantee the renewable source  
of the electrical energy used in the period

01.01.2024 - 31.12.2024

UNA VITA PIÙ AZZURRA È POSSIBILE  
A BLUER WORLD IS POSSIBLE

CONDIZIONI DI VENDITA

Alle vendite si applicano le condizioni generali di vendita e la garanzia pubblicati sul nostro sito internet [www.panzeri.it](http://www.panzeri.it) alla data di accettazione dell'ordine da parte di Panzeri Carlo SRL

SALES CONDITIONS

Sales are regulated by the general export sales conditions and warranty published on our website [www.panzeri.it](http://www.panzeri.it) at the time of confirmation of the order by Panzeri Carlo SRL





ADERENTE AD ASSOLOMBARDA  
CONFINDUSTRIA MILANO MONZA E BRIANZA



Riconoscimento attribuito per oltre 50 anni di attività  
Recognition given for over 50 years of continuous activity



**ADIMEMBER**

ADI ASSOCIAZIONE PER IL DISEGNO INDUSTRIALE

**AIDI**

Associazione  
Italiana  
di Illuminazione

Pur mantenendo inalterate le proprie caratteristiche di base, i nostri articoli possono risultare parzialmente modificati rispetto a come sono raffigurati nel presente catalogo. Ciò è dovuto all'evoluzione a cui sottoponiamo i prodotti, con lo scopo di un miglioramento continuo. Anche i colori presentati nel catalogo sono da considerarsi puramente indicativi.

While maintaining the basic characteristics of the product, the Company reserves the right to make modifications at any time with the sole aim of improvement. The colours illustrated in the catalogue are intended only as examples.

# PANZERI

## PANZERI CARLO S.R.L.

Via Padania, 6/8 - 20853  
Biassono MB - Italy  
Sede Legale:  
Via Mameli, 11 - 20851  
Lissone MB - Italy  
T +39 039 2497483  
F +39 039 2497396  
panzeri@panzeri.it  
export@panzeri.it  
**panzeri.it**

## Show-room Milano

Arena Listone Giordano  
Via S. Cecilia, 6 - 20122  
Milano - Italia

## PANZERI & PARTNERS GMBH

T +49 89 209 607 40  
F +49 89 209 607 41  
info@panzeri-partners.de  
**panzeri-partners.de**

## PANZERI FRANCE SAS

**panzeri-france.fr**

## PANZERI MIDDLE EAST DMCC

Preatoni Tower, Office 2506  
Cluster L, JLT, Dubai, UAE,  
PO Box 7042  
**panzeri-me.com**

## Show-room Paris

179 Rue Lecourbe - 75015  
Paris - France





