

PANZERI

Hilow

[High-Low]



Hilow

Design by:

Matteo Thun

Un corpo illuminante in grado di caratterizzare con le sue infinite possibilità compositive la scenografia di ogni ambiente, installabile in modo libero e intuitivo verso l'alto o il basso, per illuminazione diretta o indiretta

With its countless compositional options, this luminaire adds distinctive appeal to the decor in all contexts. It allows intuitive installation wherever required, either upwards or downwards, for direct or indirect lighting



Un prodotto “double-face”
per possibilità di resa illuminante
ancora più estese

*This “double-face” luminaire offers increasingly
extensive lighting efficiency*

Luce diretta / *Direct light* = 80%
Luce indiretta / *Indirect light* = 20%

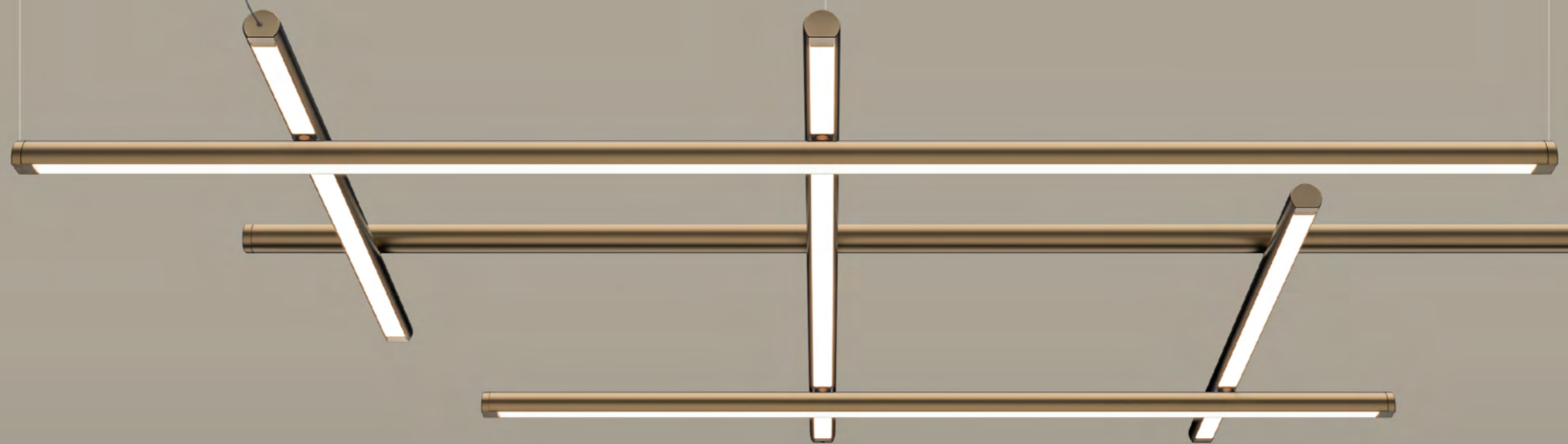

Installa **To-Be 22 mm** in posizione libera all'interno della composizione per includere uno o più elementi illuminanti verticali

*Freely install **To-Be 22 mm** in the preferred position within the composition to include one or more vertical lighting elements*

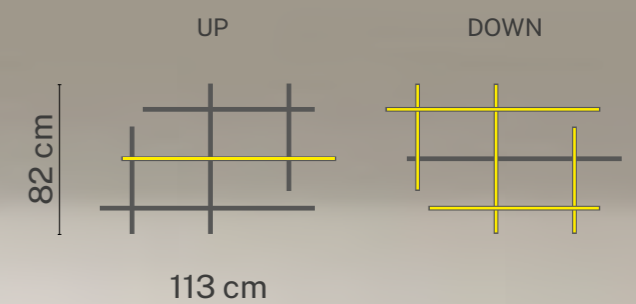

La libertà di estendere
le potenzialità del progetto
esprimendosi in modo personale

*Extend the potential of your interior designs
by adding your own personal touch*

Luce diretta / *Direct light* = 20%
Luce indiretta / *Indirect light* = 80%

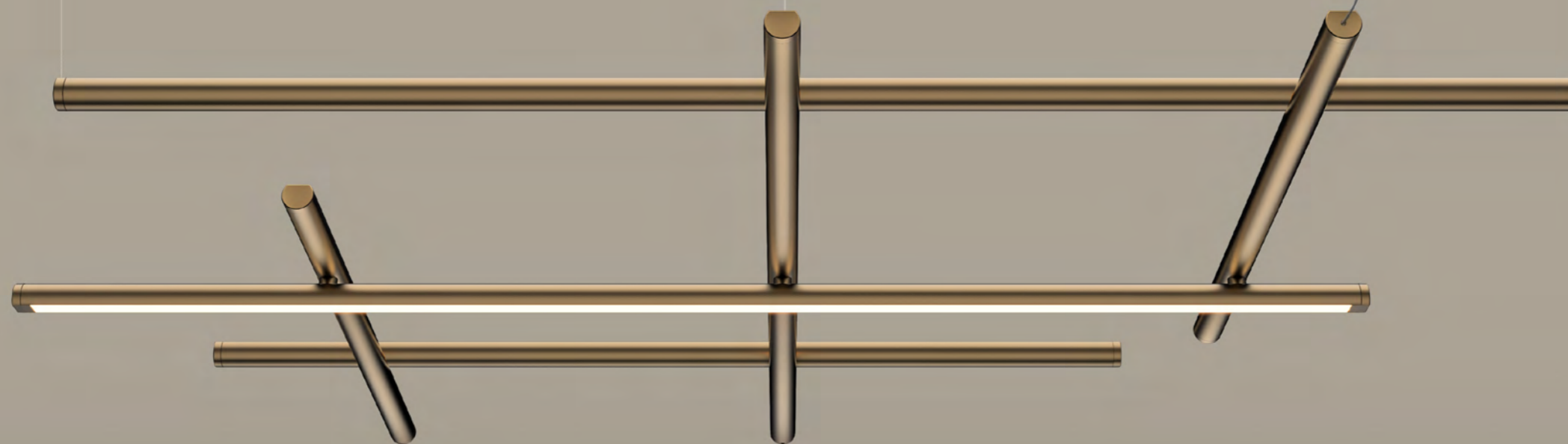

Installa **To-Be 22 mm** in posizione libera all'interno della composizione per includere uno o più elementi illuminanti verticali

*Freely install **To-Be 22 mm** in the preferred position within the composition to include one or more vertical lighting elements*

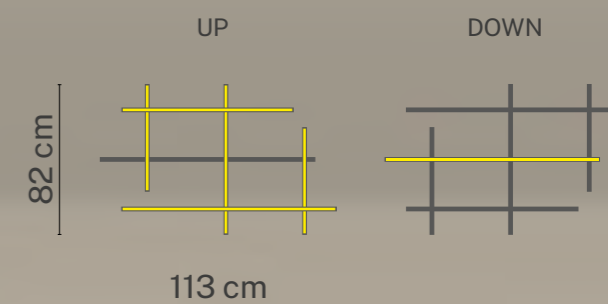



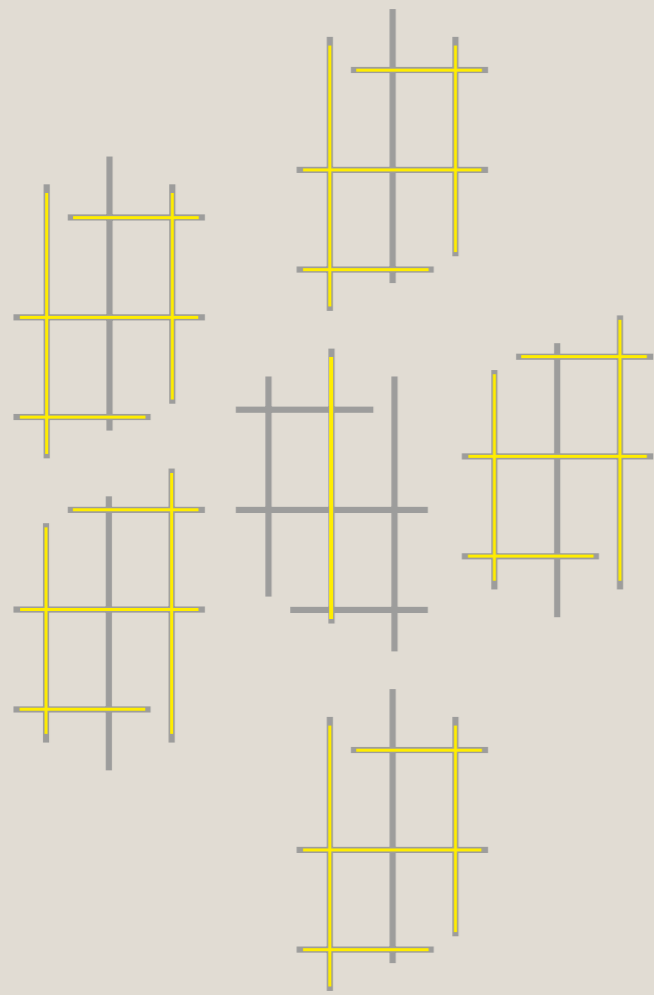

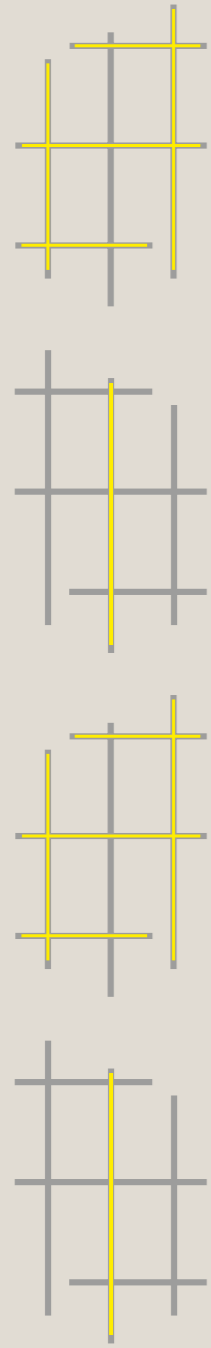

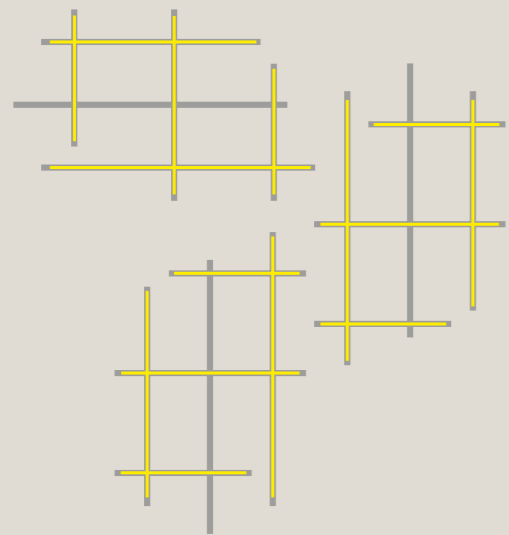
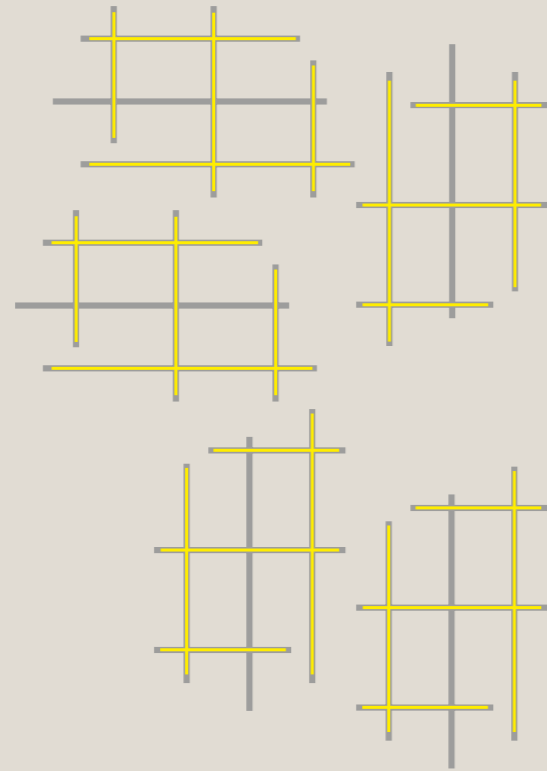



● Illuminazione verso il basso / Downward light



Living

Crea una “nuvola” di prodotti spaziatati tra loro e posizionati ad altezze differenti per una composizione ariosa al centro dello spazio

Create a “cloud” of products that are spaced out and positioned at different heights, providing an airy composition in the middle of the space

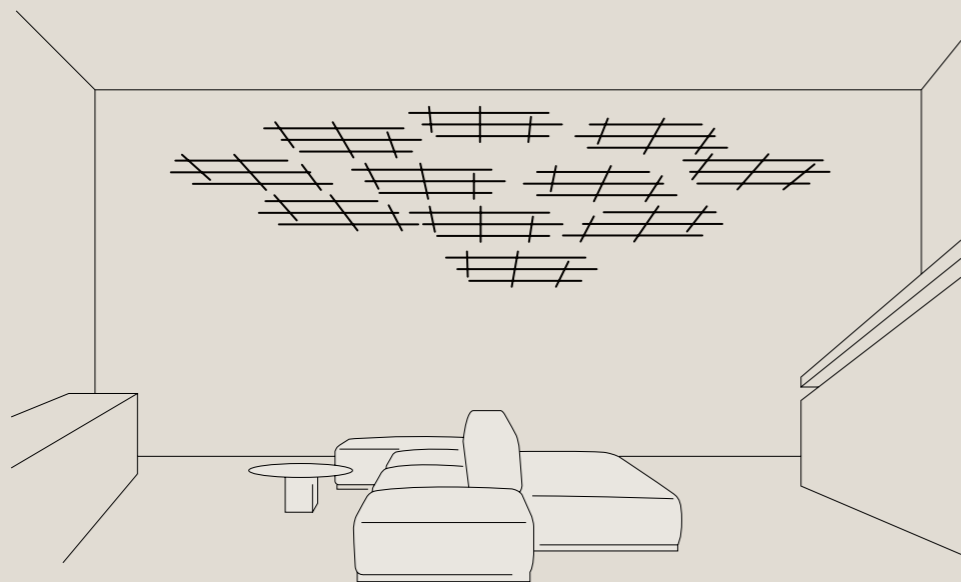

Bar

Una composizione lineare su un solo piano permette di enfatizzare la lunghezza e la geometria di un bancone bar

A linear composition at a single level allows you to accentuate the length and layout of a bar counter



Retail

Crea piccole composizioni indipendenti per evidenziare punti focali dell'ambiente

Create small independent compositions to highlight focal points of the room

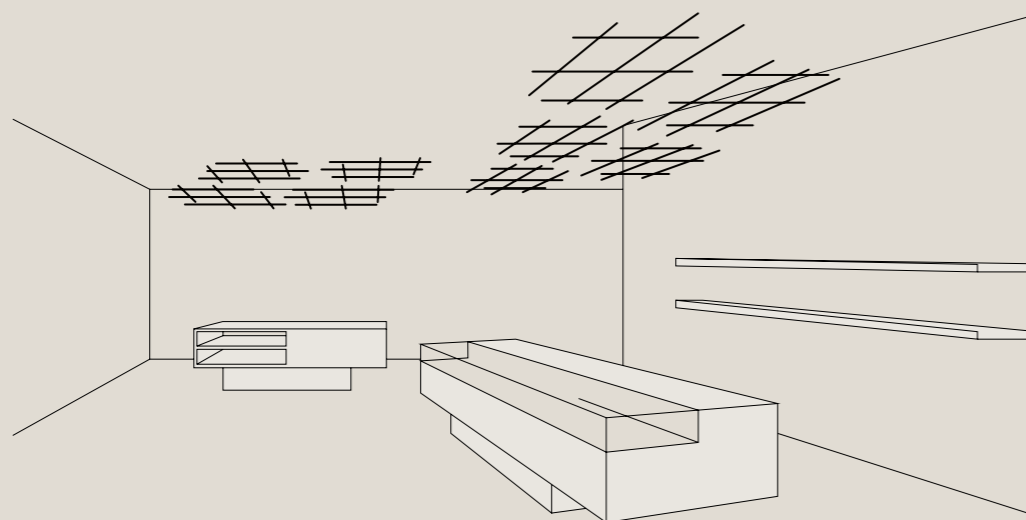

Office

Disponi i corpi illuminanti ruotandoli in modo libero tra loro per creare una composizione che si sviluppa in ogni direzione

Arrange luminaires by freely rotating them to create a composition that develops in all directions

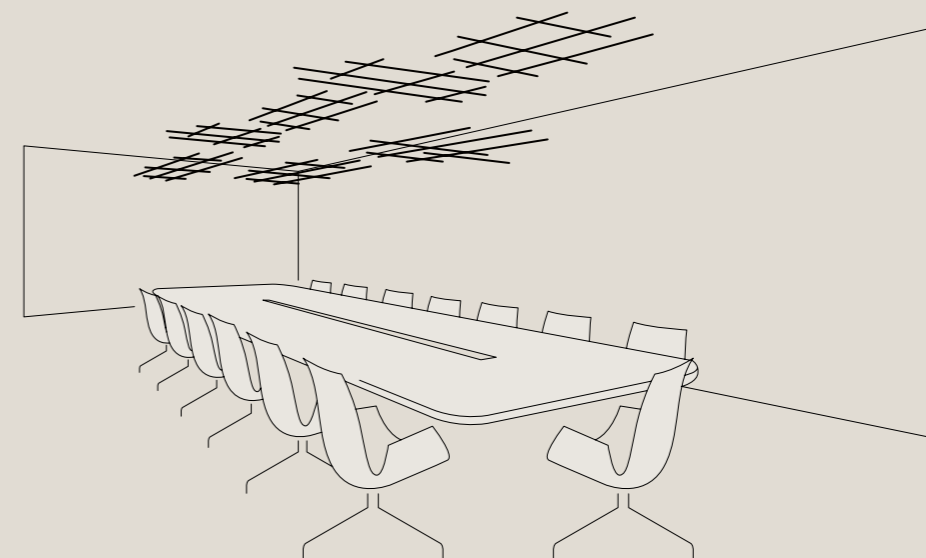

Applique
e plafone:
libertà espressiva,
funzione
e decorazione

*Wall and ceiling lights:
scope for expression,
function and decoration*





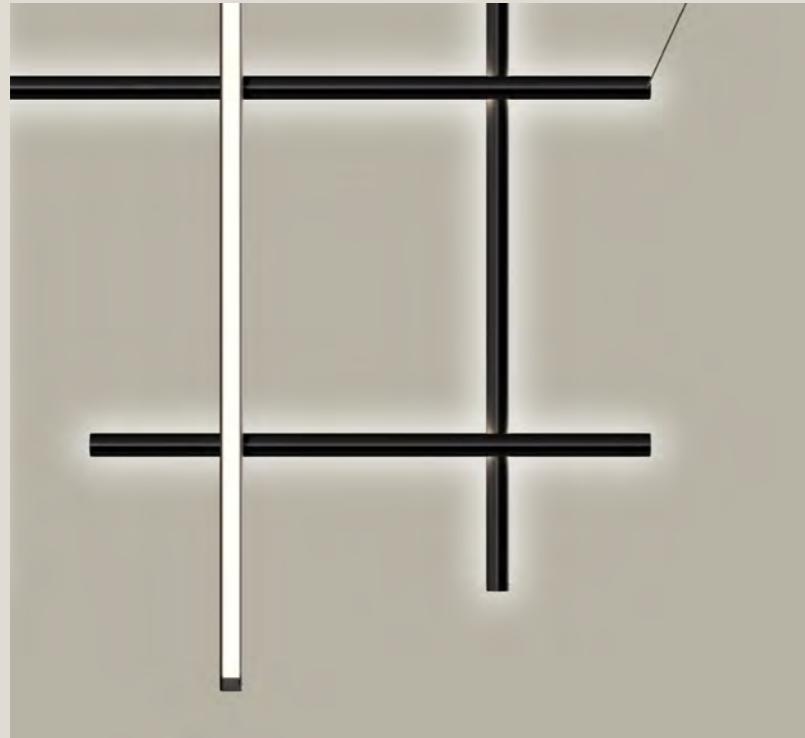

Sono i dettagli ad esaltare la leggerezza e la funzionalità di Hilow. Da un lato i giunti in ottone tornito e alluminio pressofuso che collegano gli elementi orizzontali. Dall'altro le testate di chiusura dei profili, a cui sono fissati i cavi di sospensione, che possono essere invertiti di 180° permettendo così l'installazione del prodotto sulle due facce per una maggiore illuminazione diretta o indiretta.

Details enhance the lightness and functionality of Hilow: turned brass and die-cast aluminium joints that connect horizontal elements; the end caps of the Hilow profiles, to which the suspension cables are fixed. Cables can be reversed 180°, thus allowing double-face installation for the luminaire to provide more direct or indirect lighting.

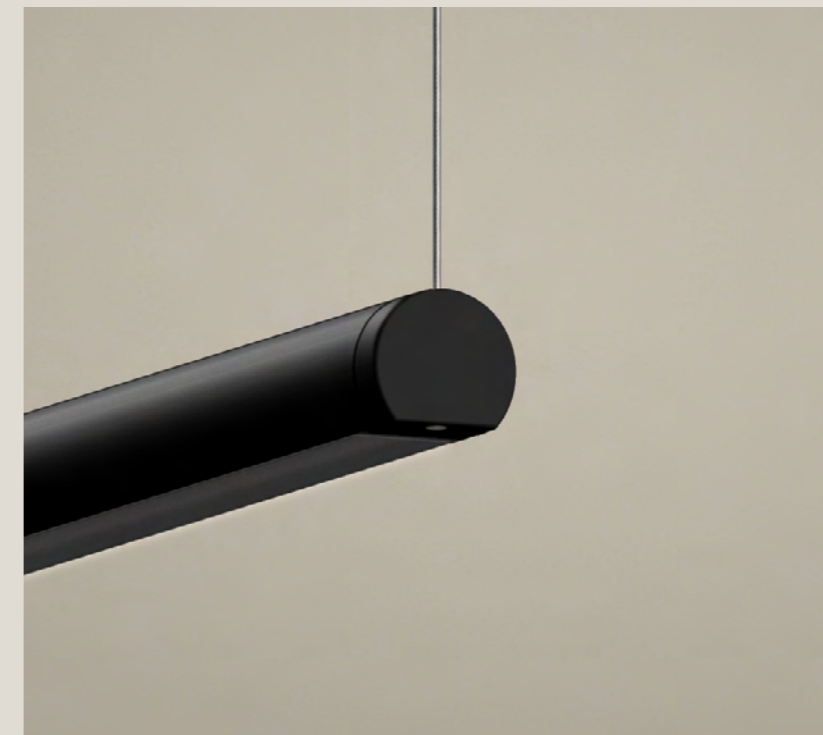
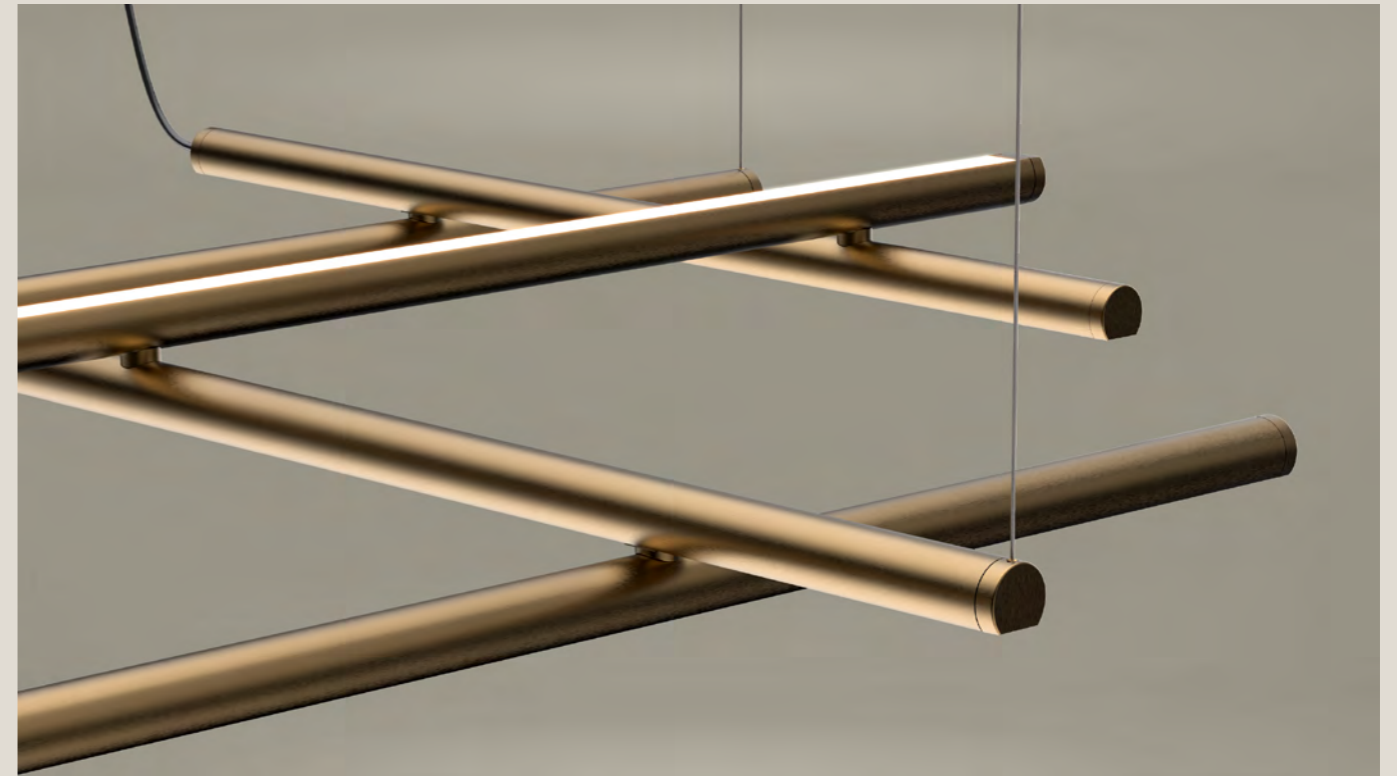

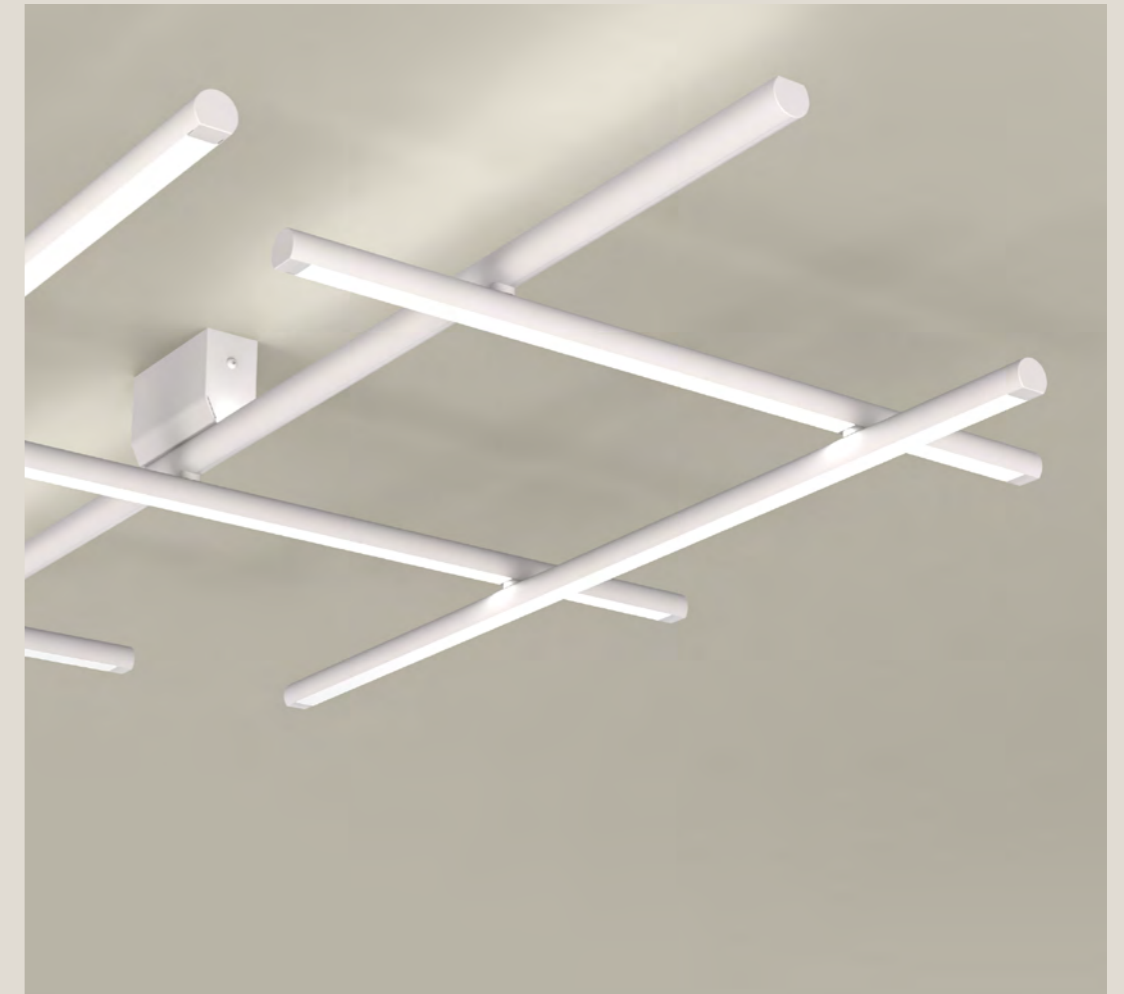

Le versioni a parete e plafone offrono grande versatilità progettuale. Sono entrambe disponibili con una duplice tipologia di attacco, una con alimentatore dimmerabile integrato e l'altra in una forma più minimale con alimentatore da installare in remoto.

La parete si configura con una stecca a luce diretta e diffusore nero per esaltare il suo carattere scultoreo e minimizzare l'abbagliamento, e cinque stecche a luce indiretta.

La plafone presenta cinque stecche a luce diretta e possibilità di scelta fra diffusore nero o opale a seconda degli obiettivi di illuminamento, ed una stecca a luce indiretta.

The wall and ceiling mount versions offer great project versatility. They are both available with a double mounting option, one with integrated dimmable power supply, the other in a more minimal form with the power supply to install remotely.

The wall mount has a configuration with one stick in direct light with black diffuser to emphasize its sculptural character and minimize the glaring, and five sticks in indirect light.

The ceiling mount offers five sticks in direct light and the choice between black or opal diffuser depending on the illumination objectives, and one stick in indirect light.



Con schermo nero /
With black screen

Con schermo opalino /
With opaline screen

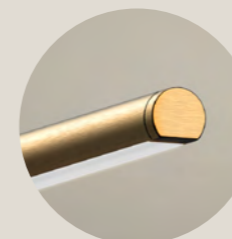
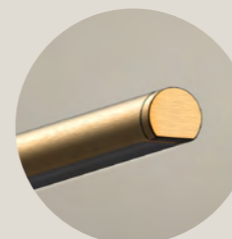
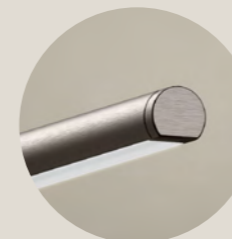
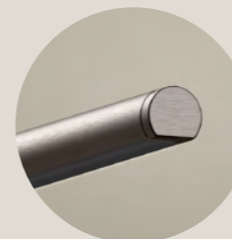
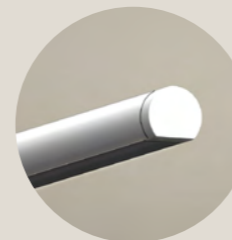
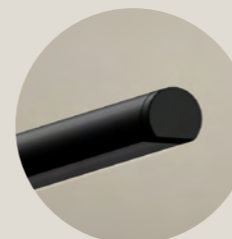

Nero satinato / Matt black

Con schermo nero / With black screen
L02906.115.0502
P02906.115.0502 - P02906.115.0510
A02906.115.0502 - A02906.115.0510
Con schermo opalino / With opaline screen
L02806.115.0502
P02806.115.0502 - P02806.115.0510

Bianco / White

Con schermo nero / With black screen
L02901.115.0502
P02901.115.0502 - P02901.115.0510
A02901.115.0502 - A02901.115.0510
Con schermo opalino / With opaline screen
L02801.115.0502
P02801.115.0502 - P02801.115.0510

Titanio / Titanium

Con schermo nero / With black screen
L02930.115.0502
P02930.115.0502 - P02930.115.0510
A02930.115.0502 - A02930.115.0510
Con schermo opalino / With opaline screen
L02830.115.0502
P02830.115.0502 - P02830.115.0510

Bronzo / Bronze

Con schermo nero / With black screen
L02917.115.0502
P02917.115.0502 - P02917.115.0510
A02917.115.0502 - A02917.115.0510
Con schermo opalino / With opaline screen
L02817.115.0502
P02817.115.0502 - P02817.115.0510

Ottone satinato / Matt brass

Con schermo nero / With black screen
L02919.115.0502
P02919.115.0502 - P02919.115.0510
A02919.115.0502 - A02919.115.0510
Con schermo opalino / With opaline screen
L02819.115.0502
P02819.115.0502 - P02819.115.0510

**Rosone con tripla uscita elettrica
per Hilow sospensione / Canopy with triple
electrical output for suspension Hilow**

Per allacciamento Hilow sospensione + fino a 2 To-Be /
For connecting suspension Hilow + up to 2 To-Be



To-Be 22 mm

Sospensione senza rosone /
Suspension without a canopy
M025_.085.0510



Specifiche tecniche / Technical specifications

L028_.115.0502
L029_.115.0502

Apparecchio di illuminazione per installazione a sospensione in ambienti interni, con emissione diretta e indiretta. Struttura in alluminio estruso con verniciatura poliacrilica in colore bianco, nero satinato, bronzo, ottone satinato o titanio. Giunti in ottone tornito e alluminio pressofuso con verniciatura poliacrilica. Testate di chiusura in alluminio pressofuso con verniciatura poliacrilica. Schermi diffusori in policarbonato estruso con finitura opalina o nera. Kit di sospensione reversibile con dispositivi di regolazione rapida e funi in acciaio di lunghezza 5m (196,9"). Cavo di alimentazione in PVC trasparente di lunghezza 5m (196,9"). Rosone per collegamento elettrico con 3 uscite (per 1 Hilow + fino a 2 To-Be 22 mm) con verniciatura poliacrilica in colore bianco, nero satinato, bronzo, ottone satinato o titanio.

Suspension lighting fixture for interiors, with direct and indirect light emission. Extruded aluminium structure in white, matt black, bronze, matt brass or titanium polyacrylic paint. Joints in turned brass and die-cast aluminium in polyacrylic paint. Die-cast aluminium end caps in polyacrylic paint. Extruded polycarbonate diffusers with opaline or black finish. Reversible suspension kit with griplocks and 5m (196,9") long steel cables. 5m (196,9") long power cable in transparent PVC. Canopy for power supply with 3 outputs (for 1 Hilow + up to 2 To-Be 22mm) in white, matt black, bronze, matt brass or titanium polyacrylic paint.



	Con schermo opalino / With opaline screen	Con schermo nero / With black screen
Code	L028_.115.0502	L029_.115.0502
System power consumption	77W	77W
Efficacy	65,52lm/W	27,51lm/W
Light source	LED	LED
Light source lifetime	L70 (B10) 60.000h	L70 (B10) 60.000h
Colour temperature	2700K RA>90	2700K RA>90
Light distribution	Diffused	Diffused
Power supply	220-240V AC	220-240V AC
Frequency	50/60Hz	50/60Hz
Electrical configuration	Dimmable (DALI/Push DIM)	Dimmable (DALI/Push DIM)
Driver	Integrated included	Integrated included
Nominal Luminous Flux	9072lm	9072lm
Lumen Output	5045lm	2118lm
Efficiency	56%	23%
Weight	2,4Kg	2,4Kg
Colour tollerances	SDCM 3	SDCM 3

Codici colori disponibili / Available colour codes

Bianco / White	01	Ottone satinato / Matt brass	19
Nero satinato / Matt black	06	Titanio / Titanium	30
Bronzo / Bronze	17		

Orientamenti di installazione / Installation layouts

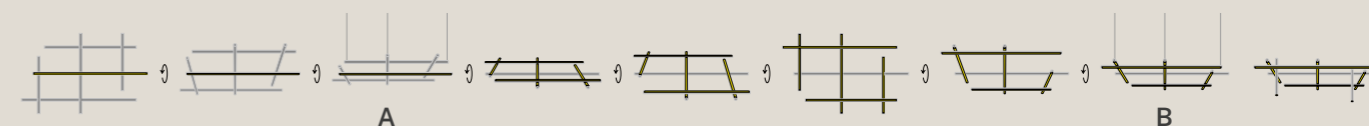

Disegni tecnici / Technical drawings

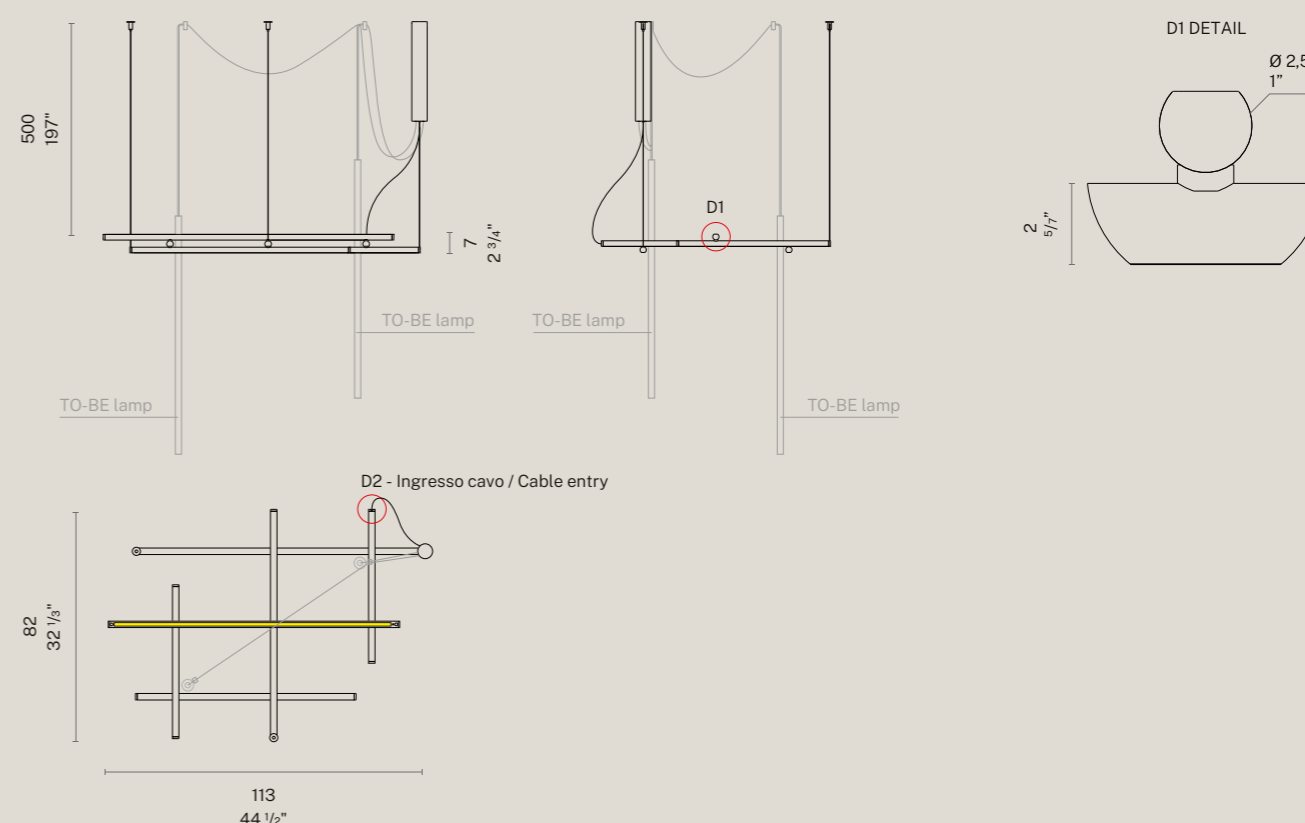

Disegni tecnici rosone /
Canopy technical drawings



Diagramma polare con schermo opalino /
Polar diagram with opaline screen



Diagramma polare con schermo nero /
Polar diagram with black screen

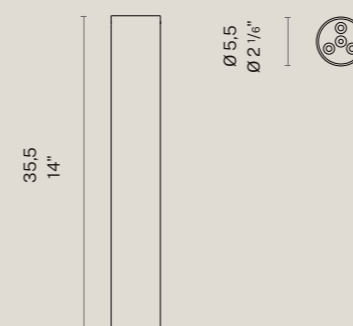

Specifiche tecniche / Technical specifications

P028_.115.0502 - P029_.115.0502
 P028_.115.0510 - P029_.115.0510

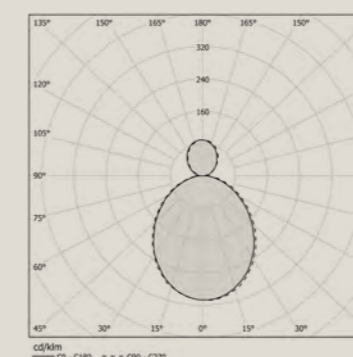
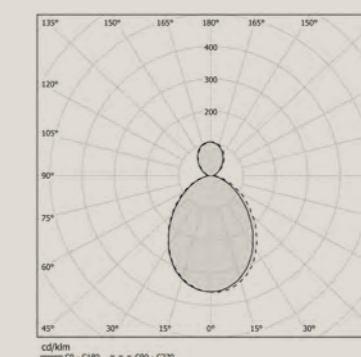
Apparecchio di illuminazione per installazione a soffitto in ambienti interni, con emissione diretta e indiretta. Struttura in alluminio estruso con verniciatura poliaccrilica in colore bianco, nero satinato, bronzo, ottone satinato o titanio. Giunti in ottone tornito e alluminio pressofuso con verniciatura poliaccrilica. Testate di chiusura in alluminio pressofuso con verniciatura poliaccrilica. Schermi diffusori in policarbonato estruso con finitura opalina per la luce indiretta e a scelta con finitura nera o opalina per la luce diretta. Disponibile in versione con alimentatore integrato nella basetta o in una versione con basetta di minori dimensioni per installazione dell'alimentatore in remoto.

Ceiling mount lighting fixture for interiors, with direct and indirect light emission. Extruded aluminium structure in white, matt black, bronze, matt brass or titanium polyacrylic paint. Joints in turned brass and die-cast aluminium in polyacrylic paint. Die-cast aluminium end caps in polyacrylic paint. Extruded polycarbonate diffusers with opaline finish for the indirect light and a choice of black or opaline finish for the direct light. Available in two versions: one with power supply integrated into the mounting base and one with a smaller base for remote installation of the driver.



	Con schermo opalino / With opaline screen	Con schermo nero / With black screen	Con schermo opalino / With opaline screen	Con schermo nero / With black screen
Code	P028_.115.0502	P029_.115.0502	P028_.115.0510	P029_.115.0510
System power consumption	71W	71W	75W	75W
Efficacy	65lm/W	33lm/W	65lm/W	35lm/W
Light source	LED	LED	LED	LED
Light source lifetime	L70 (B10) 60.000h	L70 (B10) 60.000h	L70 (B10) 60.000h	L70 (B10) 60.000h
Colour temperature	2700K RA>90	2700K RA>90	2700K RA>90	2700K RA>90
Light distribution	Diffused	Diffused	Diffused	Diffused
Power supply	220-240V AC	220-240V AC	-	-
Frequency	50/60Hz	50/60Hz	-	-
Electrical configuration	Dimmable (DALI/Push DIM)	Dimmable (DALI/Push DIM)	24V DC	24V DC
Driver	Integrated included	Integrated included	Not included	Not included
Nominal Luminous Flux	8316lm	8316lm	8820lm	8820lm
Lumen Output	4602lm	2356lm	4897lm	2651lm
Efficiency	55%	28%	55%	30%
Weight	2,4Kg	2,4Kg	2,1Kg	2,1Kg
Colour tollerances	SDCM 3	SDCM 3	SDCM 3	SDCM 3

Codici colori disponibili / Available colour codes

Bianco / White	01	Ottone satinato / Matt brass	19
Nero satinato / Matt black	06	Titanio / Titanium	30
Bronzo / Bronze	17		

P028_.115.0502 - P029_.115.0502 Disegni tecnici / Technical drawings



P028_.115.0510 - P029_.115.0510 Disegni tecnici / Technical drawings



Diagramma polare con schermo opalino /
Polar diagram with opaline screen



Diagramma polare con schermo nero /
Polar diagram with black screen



Specifiche tecniche / Technical specifications

A029_.115.0502
A029_.115.0510

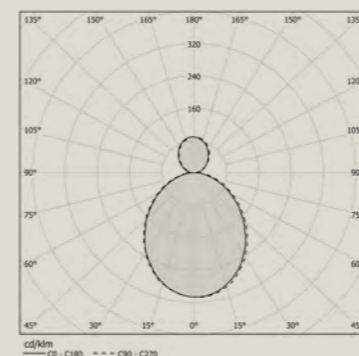
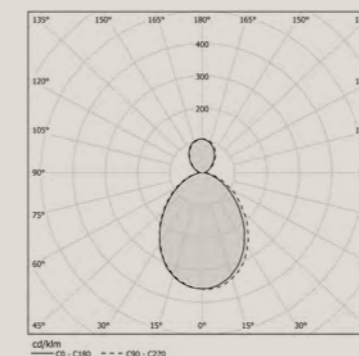
Apparecchio di illuminazione per installazione a parete in ambienti interni, con emissione diretta e indiretta. Struttura in alluminio estruso con verniciatura poliaccrilica in colore bianco, nero satinato, bronzo, ottone satinato o titanio. Giunti in ottone tornito e alluminio pressofuso con verniciatura poliaccrilica. Testate di chiusura in alluminio pressofuso con verniciatura poliaccrilica. Schermi diffusori in policarbonato estruso con finitura opalina per la luce indiretta e con finitura nera per la luce diretta. Disponibile in versione con alimentatore integrato nella basetta o in una versione con basetta di minori dimensioni per installazione dell'alimentatore in remoto.

Wall mount lighting fixture for interiors, with direct and indirect light emission. Extruded aluminium structure in white, matt black, bronze, matt brass or titanium polyacrylic paint. Joints in turned brass and die-cast aluminium in polyacrylic paint. Die-cast aluminium end caps in polyacrylic paint. Extruded polycarbonate diffusers with opaline finish for the indirect light and black finish for the direct light. Available in two versions: one with power supply integrated into the mounting base and one with a smaller base for remote installation of the driver.



	Con schermo nero / With black screen	Con schermo nero / With black screen
Code	A029_.115.0502	A029_.115.0510
System power consumption	68W	73W
Efficacy	56lm/W	56lm/W
Light source	LED	LED
Light source lifetime	L70 (B10) 60.000h	L70 (B10) 60.000h
Colour temperature	2700K RA>90	2700K RA>90
Light distribution	Diffused	Diffused
Power supply	220-240V AC	-
Frequency	50/60Hz	-
Electrical configuration	Dimmable (DALI/Push DIM)	24V DC
Driver	Integrated included	Not included
Nominal Luminous Flux	8064lm	8568lm
Lumen Output	3812lm	4088lm
Efficiency	47%	47%
Weight	2,4Kg	2,1Kg
Colour tollerances	SDCM 3	SDCM 3

Codici colori disponibili / Available colour codes

Bianco / White	01	Ottone satinato / Matt brass	19
Nero satinato / Matt black	06	Titanio / Titanium	30
Bronzo / Bronze	17		

A029_.115.0502 Disegni tecnici / Technical drawings

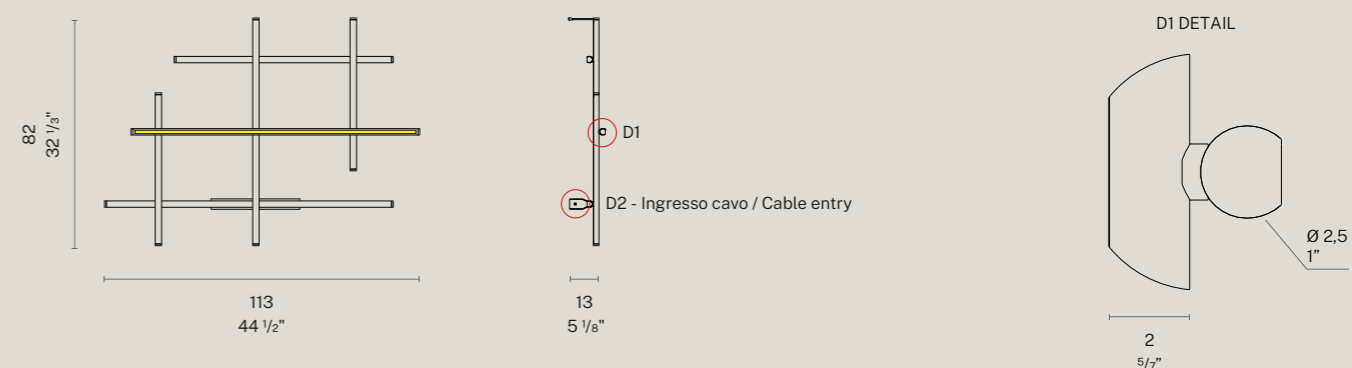

A029_.115.0510 Disegni tecnici / Technical drawings

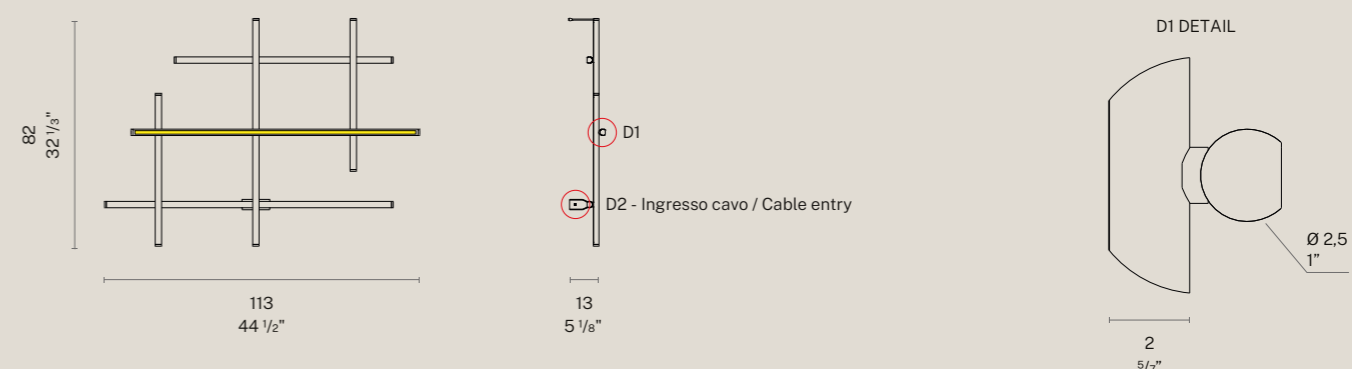

Diagramma polare / Polar diagram

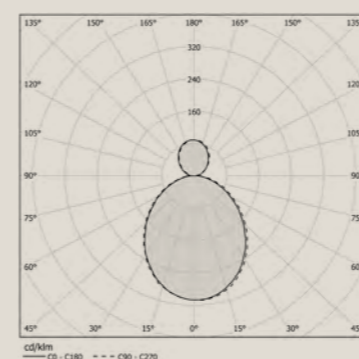

PANZERI