

Catalogo Tecnico
Technical Catalog
2026

PANZERI

Le carte utilizzate per la stampa di questo listino sono riciclate e certificate FSC®. La carta della copertina è un prodotto unico nel suo genere, che pur avendo una rilevante presenza di riciclo nell'impasto, grazie all'utilizzo di fibre di cotone mantiene una particolare morbidezza alla superficie. Carta composta da 25% di pura cellulosa certificata FSC®, 25% fibre di riciclo certificate FSC®, 40% di cellulosa CTMP e 10% fibre di cotone.

The papers used for printing this price list are recycled and certified FSC®. The cover page is a product unique in its genre. Despite a relevant presence of recycled material in the blend, it maintains an exceptional surface smoothness thanks to the adding of cotton fibers. Composite papers made of 25% of pure cellulose certified FSC®, 25% recycled fibers certified FSC®, 40% CTMP cellulose, and 10% cotton fibers.



PANZERI

LISTINO PREZZI 04.2026
PRICE LIST 04.2026

INDOOR	11
OFFSET AND CANOPIES	102
ACOUSTIC	113
OUTDOOR	116
PROFILES	125
SPOTLIGHT	147
RECESSED	188
ELECTRIC OPTIONS	204
TECHNICAL INFORMATION	210

IL PRESENTE LISTINO È VALIDO DAL 1 APRILE 2026, ANNULLA E SOSTITUISCE IL PRECEDENTE. PREZZI IVA ESCLUSA. I PREZZI DI VENDITA AL PUBBLICO VANNO CALCOLATI AGGIUNGENDO L'IMPORTO DELL'IVA VIGENTE.

PRICE LIST VALID AS FOR APRIL, 1ST 2026 AND CANCELS AND REPLACES THE PREVIOUS ONE. PRICES ARE WITHOUT V.A.T.

INTERNO / INDOOR



432 WAYS
12



ADAMAS
18



APP
20



ARENA
21



BELLA
23



BOW
25



BROOKLYN LINE
28



BROOKLYN ROUND
29



CANDLE
32



CARL
33



CLIO
66



CÔTE
34



CROSS
35



DIP
36



NEW



EMMA
65



FIREFLY IN THE SKY
38

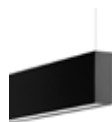

GIANO
39



GILBERT
41



GINEVRA
42



GOLDEN RING
44



GONG
48



GONIO
49



HILOW
50



HILOW LINE
53



NEW



JACKIE
55



LOLA
57



MURANÉ
58



MURANÉ R
60



OLIVIA
64



OMBRA
67



OPUNTIA
69



RENDEZ-VOUS
70



ROMA
72



RORIS
74



SCENT
76



NEW



SCENT PIXEL
77



NEW



SILVER RING
46



SMOKE
80



SUPERBOLD
81



THREE
82



TO-BE
83



TOY R
85



TOY S
87



TUBINO
89



TUBINO PLUS
91



YPSILON
92



ZERO ELLIPSE
100



ZERO LINE
93



ZERO ROUND
95



ZERO ROUND
SMART 94



ZERO SQUARE
101



ZERO ROUND
VERTICAL 98



ROSONI E DECENTRAMENTI / OFFSET AND CANOPIES



CANOPIES FOR
MULTIPLE FIXING
108



OFFSET
CANOPIES
105



OFFSET
ACCESSORIES
106



RECESSED
CANOPIES
107



ZERO SHAPES
CANOPIES
103

ACUSTICA / ACOUSTIC



ARENA ACOUSTIC

114



ZERO ROUND ACOUSTIC

115



ESTERNO / OUTDOOR



DIP

117



FIREFLY IN THE SKY

118



RALPH

120



ROMA

122



VENEXIA

123



PROFILI / PROFILES



BROADWAY

144



BRONX

126



BROOKLYN

128



BROOKLYN OUT

128



BROOKLYN TRIM

128



CORNER

133



GIANO

135



HARLEM

138



KIPS

140



KIPS ROUND

139



MANHATTAN

141



NOOK

145



PROIETTORI / SPOTLIGHT



ASTORIA IN
152



ASTORIA OUT
154



ASTORIA LINE
151



ASTORIA SPOT
151



ASTORIA 8
148



ASTORIA 5
149



ASTORIA 3
150



QUEENS
161



QUEENS 45
157



QUEENS 25
158



QUEENS 20
159



QUEENS 10
160



SOHO IN
167



SOHO OUT
169



SOHO LINE
166



SOHO 20
163



SOHO 10
164



SOHO 5
165



STREET IN
184



STREET OUT
186



432 WAYS
171



BELLA
172



MURANÉ
173



RENDEZ-VOUS
174



SCENT
175



NEW



STREET 8
178



STREET 5
179



STREET 3
180



STREET LINE
181



STREET SPOT
181



TO-BE
177



INCASSI / RECESSED



CLICK CLACK
189



EAST
190



EDDIE
193



JAMES
194



JARVIS
195



JESSIE
196



JOE
203



MOAI
192



NICK
197



RALLY TRIM
199



SID
201



TAYLOR
202



ELECTRIC OPTIONS



205

TECHNICAL INFORMATION

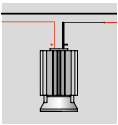

210

TIPOLOGIE DI INSTALLAZIONE / MOUNTING TYPES

SOSPENSIONE / SUSPENSION PARETE / WALL SOFFITTO / CEILING TAVOLO / TABLE TERRA / FLOOR BINARIO / TRACK

DESIGN

432 WAYS	•		•			•
ADAMAS	•			•	•	
APP		•				
ARENA	•					
BELLA	•	•		•		•
BOW		•	•			
BROOKLYN LINE	•					
BROOKLYN ROUND	•	•	•			
CANDLE	•					•
CARL			•			
CLIO	•					•
CÔTE	•	•	•			
CROSS		•				
DIP	•	•	•		•	
EMMA	•					•
FIREFLY in the sky				•		
GIANO	•	•				
GILBERT	•		•	•		•
GINEVRA	•	•	•			
GONIO		•				
GOLDEN RING	•					
GONG	•					
HILOW	•	•	•			
HILOW LINE		•			•	
JACKIE		•	•	•	•	
LOLA		•	•			
MURANÈ	•	•	•			•
MURANÈ R	•					
OLIVIA	•					•
OMBRA	•	•		•	•	
OPUNTIA		•		•		
RENDEZ-VOUS	•					•
ROMA	•	•			•	
RORIS		•	•	•		
SCENT	•					•
SCENT PIXEL	•					
SILVER RING	•	•	•			
SMOKE	•					•
SUPERBOLD		•	•			
THREE		•	•			
TO-BE	•		•			•
TOY R		•				
TOY S		•				
TUBINO	•	•	•	•	•	
TUBINO PLUS				•		
YPSILON		•				
ZERO ELLIPSE	•					
ZERO LINE		•	•			
ZERO ROUND	•	•	•			
ZERO ROUND VERTICAL	•					
ZERO SQUARE	•					

ACUSTICA

ARENA ACOUSTIC	•					
ZERO ROUND ACOUSTIC	•					

OUTDOOR

DIP					•	
FIREFLY in the sky				•	•	
RALPH	•	•		•	•	
ROMA					•	
VENEXIA	•	•			•	

VADEMECUM LETTURA LISTINO / HOW TO READ PRICE LIST

Codice Qr / Qr-code **Nome della famiglia** / Family name **Foto** / Picture **Progettista e anno, eventuale registrazione** / Designer, year and possible registration **Descrizione** / Description

ZERO (Studio Tonino Panzeri 2012) Registered Design

Lampade da parete/soffitto in metallo bianco, cromo, bronzo, ottone satinato e foglia oro complete di LED e driver. Wall/ceiling lamps in white metal, chrome, bronze, mat brass and gold leaf complete with LED and driver.

Tipo di emissione luminosa / Light output **Dati e caratteristiche tecniche** / Data and technical details **Potenza e flusso luminoso effettivi** / Effective power and luminous flux

CODICE CODE	FONTE LUMINOSA LIGHT SOURCES	kg	€
A03501.050.0401	Potenza assorbita apparecchio / Luminaire power consumption 11W Flusso luminoso apparecchio / Luminaire luminous flux 613lm 3000K Ra90 220-240V AC ON-OFF	1,37	277,00
A03512.050.0401			350,00
A03519.050.0401			326,00
A03521.050.0401			369,00
A03522.050.0401			338,00

Potenza assorbita apparecchio / Luminaire power consumption 109W
Flusso luminoso apparecchio / Luminaire luminous flux 5931lm
3000K Ra>90 220-240V AC dimmable (DALI/PUSH DIM)

IP20 IP20 850°

Peso netto in kg / Net price in kilos

Prezzo di listino a seconda della finitura / Price list according to finishing

Disegno con dimensioni in cm e pollici / Drawing with dimensions in cm and inches

Possibilità di installazione / Fixing prospect

Le fotometrie di sporcio il www.panzeri.it / Photometric data available at www.panzeri.it

CODICI COLORI DISPONIBILI / COLOUR CODES AVAILABLE **Disponibili a richiesta LED 2700K / On request 2700K LED available**

01 bianco / white 02 nero / black 13 ottone satinato / mat brass

Finiture disponibili / Finishing available

Eventuali temperature di colore a richiesta / Possible light colour temperature on demand

SIGNIFICATO DELLA CODIFICA / CODE MEANING

Vedi tabella a fianco / See table on side

XG	231	01	360	00	99	Profilo da incasso Brooklyn round 100 360° No led No alimentazione / Recessed track Brooklyn round 100 white 360° No led No Electricity
A	016	37	025	01	01	Lampada da parete Toy acciaio inox lucido 25 cm Led 3000K Ra80 Alimentazione standard / Wall lamp Toy Polished stainless steel 25 cm 3000K Ra80 Standard power supply
C	077	03	000	04	13	Lampada da tavolo Jackie Rossa Led 3000K Ra90 lot step dim / Table lamp Jackie Red 3000K Ra90 lot step dim
L	081	21	180	01	02	Sospensione Golden Ring Foglia oro diametro 180 cm Led 3000K Ra80 DALI/PUSH DIM / Suspension Golden Ring gold leaf diameter 180 3000K Ra80 DALI/PUSH DIM

Eletrificazione / Electricity

Qualità della luce / Light quality

Dimensione caratteristica / Typical dimension

Numero di famiglia / Family number

Tipologia di installazione / Type of mounting

LEGENDA / LEGEND



Emissione luminosa diretta e indiretta / Direct and indirect light emission



Emissione luminosa solo indiretta / Indirect light emission only



Emissione luminosa solo diretta / Direct light emission only



Apparecchio con possibilità di installazione a plafone / Fixture suitable for ceiling



Apparecchio da parete / Wall fixture



Apparecchio con possibilità di installazione a parete e plafone / Fixture suitable for ceiling and wall fixing

SISTEMA DI CODIFICA / CODE SYSTEM

Tipologia di installazione	Legenda	Finiture diffusori	Legenda	K /Ra /°	Legenda	Elettrificazione	Legenda
Type of mounting	Legend	Colour finish diffuser	Legend	K /Ra /°	Legend	Electricity	Legend
A	parete / wall	00	nessuna / unfinished	00		00	standard
B	attacco a binario / electrical adapter	01	bianco / white	01	3000K/80	01	alimentazione standard standard power supply
C	tavolo / table	02	nero / black	02	2700K/80		
CA	parete-mensola / wall bracket	05	champagne / champagne	03	4000K/80	02	alimentazione DALI / PUSH DIM DALI / PUSH DIM power supply
CM	tavolo morsetto / table clamp	06	nero satinato / matte black	04	3000K/90		
CP	tavolo perno / table bolt down	07	avorio / ivory	05	2700K/90	03	alimentazione 1-10V / Push DIM 1-10V / PUSH DIM power supply
EA	esterno parete / exterior wall	16	corten / corten	06	4000K/90		
EC	esterno tavolo / exterior table	17	bronzo / bronze	11	2700K/80/NS	04	taglio di fase / phase cut
EL	esterno sospensione exterior suspension	19	ottone satinato / matte brass	12	2700K/80/S	05	RGB
		21	foglia oro / gold leaf	13	2700K/80/FL	06	LED tensione di rete / 220V LED
EP	esterno soffitto / exterior ceiling	22	cromo / chrome	14	2700K/80/WFL	07	emergenza / emergency
ET	esterno terra / exterior floor	23	foglia argento / silver leaf	15	2700K/90/NS	08	mono standard
L	sospensione / suspension	24	foglia rame / copper leaf	16	2700K/90/S	09	Step DIM
M	sospensione senza rosone suspension without canopy	26	blu mirto materico / textured myrtle blue	17	2700K/90/FL	10	24V
		27	verde oliva materico / textured olive green	18	2700K/90/WFL	11	12V
P	soffitto / ceiling	28	bianco soft materico / textured soft white	19	3000K/80/NS	12	alimentazione a due livelli bilevel driver
PE	esterno terra picchetto exterior floor peg	29	terracotta naturale materico / textured natural terracotta	20	3000K/80/S		
		30	titanio / titanium	21	3000K/80/FL	13	IoT-Step DIM
T	terra / floor	34	grigio micaceo / micaceous grey	22	3000K/80/WFL	14	batteria / battery
X	incasso / recessed downlight	40	titanio-diffusore fumè / titanium-smoky grey diffuser	23	3000K/90/NS	15	corrente costante / constant current
XG	sistema da incasso recessed linear system	41	titanio-diffusore bianco / titanium-white diffuser	24	3000K/90/S	16	48V
		42	gesso / plaster	25	3000K/90/FL	17	bianco dinamico/tunable white
XGQ	invisibile senza cornice quadrato recessed trimless squared	43	titanio - diffusore verde foresta / titanium - forest green diffuser	26	3000K/90/WFL	18	24V DALI/Push DIM + corrente costante standard DALI/Push DIM 24V + standard constant current
		44	marrone metallizzato / metallized brown	27	4000K/90/NS		
XGR	invisibile senza cornice tondo recessed trimless round	45	legno-ottone satinato / wood-mat brass	28	4000K/90/S	19	48V DALI
		46	bianco-policarbonato opale / white-opal polycarbonate	29	4000K/90/FL		
XM	accessorio / accessory	47	bianco-policarbonato prismatico / white-microprismatic polycarbonate	30	4000K/90/WFL	20	DALI
XP	sistema sosp-soffitto-parete suspension-ceiling-wall system	48	nero-policarbonato opale / black-opal polycarbonate	31	3000K, CRI>85	21	DIM-to-warm + bianco dinamico DIM-to-warm + tunable white
		49	nero-policarbonato prismatico / black-microprismatic polycarbonate	32	2700K, CRI>85		
Y	accessorio / accessory	51	nero-diffusore bianco / black-white diffuser	33	4000K, CRI>85	22	dimmer su cavo / dimmer on cable
		52	nero-diffusore cristallo / black-crystal diffuser	34	2700K, CRI>85, NS	23	wireless ZigBee
		53	nero-diffusore acciaio / black-steel diffuser	35	2700K, CRI>85, S	24	24V + corrente costante 24V + constant current
		54	nero-diffusore ambra / black-amber diffuser	36	2700K, CRI>85, FL		
		55	nero-diffusore bronzo / black-bronze diffuser	37	2700K, CRI>85, WFL	25	Wireless Casambi
		56	nero-diffusore tabacco / black-tobacco diffuser	38	3000K, CRI>85, NS	26	PWM - 0/1-10V
		57	nero-diffusore verde / black-green diffuser	39	3000K, CRI>85, S	27	dimmerabile / dimmable
		71	ottone satinato-diffusore bianco / mat brass-white diffuser	40	3000K, CRI>85, FL	99	no elettrificazione / no electricity
		72	ottone satinato-diffusore cristallo / mat brass-crystal diffuser	41	3000K, CRI>85, WFL		
		73	ottone satinato-diffusore acciaio / mat brass-steel diffuser	42	4000K, CRI>85, NS		
		74	ottone satinato-diffusore ambra / mat brass-amber diffuser	43	4000K, CRI>85, S		
		75	ottone satinato-diffusore bronzo / mat brass-bronze diffuser	44	4000K, CRI>85, FL		
		76	ottone satinato-diffusore tabacco / mat brass-tobacco diffuser	45	4000K, CRI>85, WFL		
		77	ottone satinato-diffusore verde / mat brass-green diffuser	90	2700-6500K/90		
		80	nero satinato-oro / mat black-gold	91	2200-4000K/90		
81	bianco-oro / white-gold						
83	legno / wood						

Descrizione fascio Light beam description	Legenda Legend	Gradi Degrees
Fascio strettissimo Narrow	NS	< 12°
Fascio stretto Spot	S	13° -> 21°
Fascio medio Flood	FL	22° -> 40°
Fascio largo Wide flood	WFL	41° -> 60°
Fascio diffuso Diffused	Nessuna sigla No code	> 60°

INDEX

Page	Code	Collection	Page	Code	Collection
80	015	Smoke	184	9600	Street In
49	019	Gonio	186	9600	Street Out
83-177	025 - 026 - 027	To-Be	181	B420	Street Spot
50	028 - 029	Hilow	181	B421	Street Line
93	036	Zero Line	180	B422	Street 3
82	039	Three	179	B423	Street 5
115	045	Zero Round Acoustic	178	B424	Street 8
114	046	Arena Acoustic	151	B430	Astoria Spot
120	047	Ralph	151	B431	Astoria Line
123	048	Venexia	149	B432	Astoria 5
35	049	Cross	150	B433	Astoria 3
23-172	052 - 053	Bella	148	B434	Astoria 8
34	060-061	Côte	166	B470	Soho Line
41	065	Gilbert	165	B752	Soho 5
69	068	Opuntia	164	B753	Soho 10
92	072	Ypsilon	163	B754	Soho 20
89	073	Tubino	159	B760	Queens 20
91	073	Tubino Plus	157	B770	Queens 45
21	074	Arena	128	KG233	Brooklyn
55	077	Jackie	128	KG234	Brooklyn Trim
38-118	078	Firefly in the sky	128	KP233	Brooklyn Out
70-174	080	Rendez-vous	126	KG247	Bronx
44	081	Golden Ring	202	X168	Taylor
46	082	Silver Ring	203	XA2115	Joe
36-117	084 - 085 - 086	Dip	203	XA2116	Joe
81	088	Superbold	138	XG251	Harlem
65	091	Emma	140	XG270	Kips
42	092	Ginevra	139	XG271-XG272-XG273	Kips Round
48	093	Gong	141	XG2044	Manhattan
66	094	Clio	133	XG2045	Corner
32	095	Candle	190	XGQ0998	East
64	097	Olivia	191	XGQ0998GL	East
20	098	App	191	XGQ1004	East
53	107-108-109-110	Hilow Line	191	XGQ1004-GL	East
74	112	Roris	192	XGQ1210	Moai
58-173	115-117-118-119	Murané	190	XGR0997	East
60	106-116	Murané R	189	XGR1212	Click Clack
57	120	Lola	161	XM75 - XM76	Queens
33	122-123	Carl	169	XM445	Soho Out
12-171	127	432 Ways	167	XM446	Soho In
25	138	Bow	160	XM748	Queens 10
87	141	Toy S	158	XM751	Queens 25
85	142	Toy R	135	XP246	Giano
72-122	148	Roma	144	XP248	Broadway
100	151	Zero Ellipse	145	XP250	Nook
101	152	Zero Square	195	XR130 - 131	Jarvis
94	153	Zero Round Smart	197	XR225	Nick
98	154	Zero Round Vertical	201	XR170	Sid
95	155	Zero Round	193	XR172	Eddie
67	160	Ombra	196	XR174	Jessie
18	181-182-183-184	Adamas	194	XR177	James
29	231 - 232	Brooklyn Round	199	XR178	Rally Trim
28	233	Brooklyn Line	197	XR254	Nick
39	246	Giano	198	XR262	Nick
76-175	301	Scent	102		Offset and Canopies
77	304	Scent Pixel			
152	9500	Astoria In			

INTERNO / INDOOR

12	432 WAYS
18	ADAMAS
20	APP
21	ARENA
23	BELLA
25	BOW
28	BROOKLYN LINE
29	BROOKLYN ROUND
32	CANDLE
33	CARL
66	CLIO
34	CÔTE
35	CROSS
36	DIP
65	EMMA
38	FIREFLY in the sky
39	GIANO
41	GILBERT
42	GINEVRA
44	GOLDEN RING
48	GONG
49	GONIO
50	HILOW
53	HILOW LINE
55	JACKIE
57	LOLA

58	MURANÈ
60	MURANÈ R
64	OLIVIA
67	OMBRA
69	OPUNTIA
70	RENDEZ-VOUS
72	ROMA
74	RORIS
76	SCENT
77	SCENT PIXEL
46	SILVER RING
80	SMOKE
81	SUPERBOLD
82	THREE
83	TO-BE
85	TOY R
87	TOY S
89	TUBINO
91	TUBINO PLUS
92	YPSILON
100	ZERO ELLIPSE
93	ZERO LINE
95	ZERO ROUND
101	ZERO SQUARE
94	ZERO ROUND SMART
98	ZERO ROUND VERTICAL



432 WAYS

Officina Panzeri 2024



Apparecchio di illuminazione a plafone e sospensione ad emissione diretta disponibile in 3 dimensioni, con supporto lente con ottica arretrata e lente emisferica anti-abbagliamento. Numerosissime sono le diverse possibili combinazioni che il prodotto consente di creare, permettendo di scegliere, oltre che le dimensioni e l'elettrificazione, anche gli accoppiamenti di finitura tra corpo del faretto e supporto lente. Disponibili le finiture bianco, nero, champagne, bronzo, ottone satinato, verde oliva materico e terracotta naturale materico, che rendono questo spotlight uno strumento di personalizzazione degli spazi in cui è inserito.

Direct-emission ceiling and suspension fixture available in 3 sizes, with lens holder with recessed optics and anti-glare hemispherical lens. There are many different possible combinations that the product allows to create, permitting the choice not only of dimensions and electrification, but also of finish couplings between the spotlight body and lens holder. White, black, champagne, bronze, matte brass, textured olive green and natural textured terracotta finishes are available, making this spotlight a customisation tool for the spaces in which it is placed.

	CODICE CODE	FONTI LUMINOSE LIGHT SOURCES	kg
	P12701.006.0501	Potenza assorbita apparecchio / Luminaire power consumption 6,7W	0,31
	P12702.006.0501	Flusso luminoso apparecchio / Luminaire luminous flux 753lm	
	P12705.006.0501	2700K Ra>90 220-240V AC ON-OFF	
	P12717.006.0501	IP40	
	P12719.006.0501		
	P12727.006.0501		
	P12729.006.0501		
	P12701.006.0401	Potenza assorbita apparecchio / Luminaire power consumption 6,7W	0,31
	P12702.006.0401	Flusso luminoso apparecchio / Luminaire luminous flux 773lm	
	P12705.006.0401	3000K Ra>90 220-240V AC ON-OFF	
	P12717.006.0401	IP40	
	P12719.006.0401		
	P12727.006.0401		
	P12729.006.0401		
	P12701.006.0502	Potenza assorbita apparecchio / Luminaire power consumption 6,7W	0,31
	P12702.006.0502	Flusso luminoso apparecchio / Luminaire luminous flux 753lm	
	P12705.006.0502	2700K Ra>90 220-240V AC dimmable (DALI/Push DIM)	
	P12717.006.0502	IP40	
	P12719.006.0502		
	P12727.006.0502		
	P12729.006.0502		
	P12701.006.0402	Potenza assorbita apparecchio / Luminaire power consumption 6,7W	0,31
	P12702.006.0402	Flusso luminoso apparecchio / Luminaire luminous flux 773lm	
	P12705.006.0402	3000K Ra>90 220-240V AC dimmable (DALI/Push DIM)	
	P12717.006.0402	IP40	
	P12719.006.0402		
	P12727.006.0402		
	P12729.006.0402		
	YSL12701.006.FL	Supporto lente per 432 Ways, in alluminio, con verniciatura poliaccrilica in colore bianco, nero, champagne, bronzo, ottone satinato, verde oliva materico o terracotta naturale materico.	0,07
	YSL12702.006.FL		
	YSL12705.006.FL		
	YSL12717.006.FL	Lens holder for 432 Ways, in aluminium, with polyacrylic paint finish in white, black, champagne, bronze, matte brass, textured olive green or textured natural terracotta.	
	YSL12719.006.FL		
	YSL12727.006.FL		
	YSL12729.006.FL		

Supporto lente obbligatorio non incluso, da acquistare separatamente.
Mandatory lens holder not included, to be purchased separately.





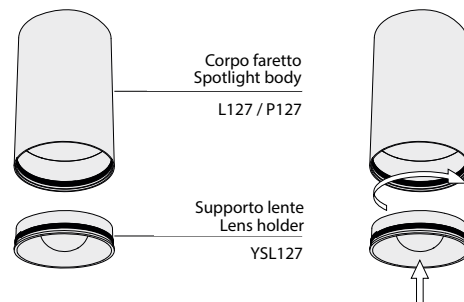





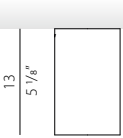

VERSIONE PER BINARIO STREET A PAGINA 171 / STREET TRACK VERSION ON PAGE 171

432 WAYS È COSTITUITO DA DUE PARTI, DA ACQUISTARE SEPARATAMENTE
432 WAYS CONSISTS OF TWO PARTS, TO BE ORDERED SEPARATELY

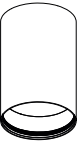

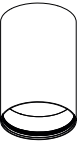
432 WAYS

Officina Panzeri 2024

	CODICE CODE	FONTI LUMINOSE LIGHT SOURCES	kg
	 P12701.008.0504	Potenza assorbita apparecchio / Luminaire power consumption 10,7W Flusso luminoso apparecchio / Luminaire luminous flux 1134lm 2700K Ra>90 220-240V AC dimmable (phase cut)  IP40	0,66
	P12702.008.0504		
	P12705.008.0504		
	P12717.008.0504		
	P12719.008.0504		
	 P12701.008.0404	Potenza assorbita apparecchio / Luminaire power consumption 10,7W Flusso luminoso apparecchio / Luminaire luminous flux 1157lm 3000K Ra>90 220-240V AC dimmable (phase cut)  IP40	0,66
	P12702.008.0404		
	P12705.008.0404		
	P12717.008.0404		
	P12719.008.0404		
	 P12701.008.0502	Potenza assorbita apparecchio / Luminaire power consumption 10,7W Flusso luminoso apparecchio / Luminaire luminous flux 1134lm 2700K Ra>90 220-240V AC dimmable (DALI/Push DIM)  IP40	0,66
	P12702.008.0502		
	P12705.008.0404		
	P12717.008.0502		
	P12719.008.0502		
	 P12701.008.0402	Potenza assorbita apparecchio / Luminaire power consumption 10,7W Flusso luminoso apparecchio / Luminaire luminous flux 1157lm 3000K Ra>90 220-240V AC dimmable (DALI/Push DIM)  IP40	0,66
	P12702.008.0402		
	P12705.008.0402		
	P12717.008.0402		
	P12719.008.0402		
	YSL12701.008.FL	Supporto lente per 432 Ways, in alluminio, con verniciatura poliaccrilica in colore bianco, nero, champagne, bronzo, ottone satinato, verde oliva materico o terracotta naturale materico. Lens holder for 432 Ways, in aluminium, with polyacrylic paint finish in white, black, champagne, bronze, matte brass, textured olive green or textured natural terracotta.	0,10
	YSL12702.008.FL		
	YSL12705.008.FL		
	YSL12717.008.FL		
	YSL12719.008.FL		

**Supporto lente obbligatorio non incluso,
da acquistare separatamente.
Mandatory lens holder not included,
to be purchased separately.**

432 WAYS

Officina Panzeri 2024

	CODICE CODE	FONTI LUMINOSE LIGHT SOURCES	kg
	P12701.010.0504	Potenza assorbita apparecchio / Luminaire power consumption 16,4W	0,88
	P12702.010.0504	Flusso luminoso apparecchio / Luminaire luminous flux 1875lm	
	P12705.010.0504	2700K Ra>90 220-240V AC dimmable (phase cut)	
	P12717.010.0504	IP40	
	P12719.010.0504		
	P12701.010.0404	Potenza assorbita apparecchio / Luminaire power consumption 16,4W	0,88
	P12702.010.0404	Flusso luminoso apparecchio / Luminaire luminous flux 1913lm	
	P12705.010.0404	3000K Ra>90 220-240V AC dimmable (phase cut)	
	P12717.010.0404	IP40	
	P12719.010.0404		
	P12701.010.0502	Potenza assorbita apparecchio / Luminaire power consumption 16,4W	0,88
	P12702.010.0502	Flusso luminoso apparecchio / Luminaire luminous flux 1875lm	
	P12705.010.0502	2700K Ra>90 220-240V AC dimmable (DALI/Push DIM)	
	P12717.010.0502	IP40	
	P12719.010.0502		
	P12701.010.0402	Potenza assorbita apparecchio / Luminaire power consumption 16,4W	0,88
	P12702.010.0402	Flusso luminoso apparecchio / Luminaire luminous flux 1913lm	
	P12705.010.0402	3000K Ra>90 220-240V AC dimmable (DALI/Push DIM)	
	P12717.010.0402	IP40	
	P12719.010.0402		
	YSL12701.010.FL	Supporto lente per 432 Ways, in alluminio, con verniciatura poliaccrilica in colore bianco, nero, champagne, bronzo, ottone satinato, verde oliva materico o terracotta naturale materico.	0,25
	YSL12702.010.FL		
	YSL12705.010.FL		
	YSL12717.010.FL		
	YSL12719.010.FL		

**Supporto lente obbligatorio non incluso, da acquistare separatamente.
Mandatory lens holder not included, to be purchased separately.**

Fotometrie disponibili www.panzeri.it / Photometric data available at www.panzeri.it

CODICI COLORI DISPONIBILI / COLOUR CODES AVAILABLE

01 bianco white	02 nero black	05 champagne champagne	17 bronzo bronze	19 ottone satinato matte brass	27 verde oliva materico textured olive green	29 terracotta naturale materico textured natural terracotta
---------------------------	-------------------------	----------------------------------	----------------------------	--	--	---





432 WAYS

Officina Panzeri 2025

	CODICE CODE	FONTI LUMINOSE LIGHT SOURCES	kg
	L12701.006.0501	Potenza assorbita apparecchio / Luminaire power consumption 6,7W	0,61
	L12702.006.0501	Flusso luminoso apparecchio / Luminaire luminous flux 753lm	
	L12705.006.0501	2700K Ra>90 220-240V AC ON-OFF	
	L12717.006.0501	IP40	
	L12719.006.0501		
	L12727.006.0501		
	L12729.006.0501		
	L12701.006.0401	Potenza assorbita apparecchio / Luminaire power consumption 6,7W	0,61
	L12702.006.0401	Flusso luminoso apparecchio / Luminaire luminous flux 773lm	
	L12705.006.0401	3000K Ra>90 220-240V AC ON-OFF	
	L12717.006.0401	IP40	
	L12719.006.0401		
	L12727.006.0401		
	L12729.006.0401		
	L12701.006.0502	Potenza assorbita apparecchio / Luminaire power consumption 6,7W	0,61
	L12702.006.0502	Flusso luminoso apparecchio / Luminaire luminous flux 753lm	
	L12705.006.0502	2700K Ra>90 220-240V AC dimmable (DALI/Push DIM)	
	L12717.006.0502	IP40	
	L12719.006.0502		
	L12727.006.0502		
	L12729.006.0502		
	L12701.006.0402	Potenza assorbita apparecchio / Luminaire power consumption 6,7W	0,61
	L12702.006.0402	Flusso luminoso apparecchio / Luminaire luminous flux 773lm	
	L12705.006.0402	3000K Ra>90 220-240V AC dimmable (DALI/Push DIM)	
	L12717.006.0402	IP40	
	L12719.006.0402		
	L12727.006.0402		
	L12729.006.0402		
	YSL12701.006.FL	Supporto lente per 432 Ways, in alluminio, con verniciatura poliaccrilica in colore bianco, nero, champagne, bronzo, ottone satinato, verde oliva materico	0,07
	YSL12702.006.FL	Lens holder for 432 Ways, in aluminium, with polyacrylic paint finish in white, black, champagne, bronze, matte brass, textured olive green or textured natural terracotta.	
	YSL12705.006.FL		
	YSL12717.006.FL		
	YSL12719.006.FL		
	YSL12727.006.FL		
	YSL12729.006.FL		

Supporto lente obbligatorio non incluso, da acquistare separatamente. Mandatory lens holder not included, to be purchased separately.

VERSIONE PER BINARIO STREET A PAGINA 171 / STREET TRACK VERSION ON PAGE 171

432 WAYS

Officina Panzeri 2025

	CODICE CODE	FONTI LUMINOSE LIGHT SOURCES	kg
	L12701.008.0504	Potenza assorbita apparecchio / Luminaire power consumption 10,7W	0,96
	L12702.008.0504	Flusso luminoso apparecchio / Luminaire luminous flux 1134lm	
	L12705.008.0504	2700K Ra>90 220-240V AC dimmable (phase cut)	
	L12717.008.0504	IP40	
	L12719.008.0504		
	L12701.008.0404	Potenza assorbita apparecchio / Luminaire power consumption 10,7W	0,96
	L12702.008.0404	Flusso luminoso apparecchio / Luminaire luminous flux 1157lm	
	L12705.008.0404	3000K Ra>90 220-240V AC dimmable (phase cut)	
	L12717.008.0404	IP40	
	L12719.008.0404		
	L12701.008.0502	Potenza assorbita apparecchio / Luminaire power consumption 10,7W	0,96
	L12702.008.0502	Flusso luminoso apparecchio / Luminaire luminous flux 1134lm	
	L12705.008.0502	2700K Ra>90 220-240V AC dimmable (DALI/Push DIM)	
	L12717.008.0502	IP40	
	L12719.008.0502		
	L12701.008.0402	Potenza assorbita apparecchio / Luminaire power consumption 10,7W	0,96
	L12702.008.0402	Flusso luminoso apparecchio / Luminaire luminous flux 1157lm	
	L12705.008.0402	3000K Ra>90 220-240V AC dimmable (DALI/Push DIM)	
	L12717.008.0402	IP40	
	L12719.008.0402		



**Supporto lente obbligatorio non incluso, da acquistare separatamente.
Mandatory lens holder not included, to be purchased separately.**

YSL12701.008.FL Supporto lente per 432 Ways, in alluminio, con verniciatura poliaccrilica in colore bianco, nero, champagne, bronzo, ottone satinato, verde oliva materico
YSL12702.008.FL Supporto lente per 432 Ways, in alluminio, con verniciatura poliaccrilica in colore bianco, nero, champagne, bronzo, ottone satinato, verde oliva materico
YSL12705.008.FL Supporto lente per 432 Ways, in alluminio, con verniciatura poliaccrilica in colore bianco, nero, champagne, bronzo, ottone satinato, verde oliva materico
YSL12717.008.FL Supporto lente per 432 Ways, in alluminio, con verniciatura poliaccrilica in colore bianco, nero, champagne, bronzo, ottone satinato, verde oliva materico
YSL12719.008.FL Supporto lente per 432 Ways, in alluminio, con verniciatura poliaccrilica in colore bianco, nero, champagne, bronzo, ottone satinato, verde oliva materico
YSL12727.008.FL Supporto lente per 432 Ways, in alluminio, con verniciatura poliaccrilica in colore bianco, nero, champagne, bronzo, ottone satinato, verde oliva materico
YSL12729.008.FL Supporto lente per 432 Ways, in alluminio, con verniciatura poliaccrilica in colore bianco, nero, champagne, bronzo, ottone satinato, verde oliva materico

432 WAYS

Officina Panzeri 2025

	CODICE CODE	FONTI LUMINOSE LIGHT SOURCES	kg
	L12701.010.0504 L12702.010.0504 L12705.010.0504 L12717.010.0504 L12719.010.0504 L12727.010.0504 L12729.010.0504	Potenza assorbita apparecchio / Luminaire power consumption 16,4W Flusso luminoso apparecchio / Luminaire luminous flux 1875lm 2700K Ra>90 220-240V AC dimmable (phase cut) IP40	1,18
	L12701.010.0404 L12702.010.0404 L12705.010.0404 L12717.010.0404 L12719.010.0404 L12727.010.0404 L12729.010.0404	Potenza assorbita apparecchio / Luminaire power consumption 16,4W Flusso luminoso apparecchio / Luminaire luminous flux 1913lm 3000K Ra>90 220-240V AC dimmable (phase cut) IP40	1,18
	L12701.010.0502 L12702.010.0502 L12705.010.0502 L12717.010.0502 L12719.010.0502 L12727.010.0502 L12729.010.0502	Potenza assorbita apparecchio / Luminaire power consumption 16,4W Flusso luminoso apparecchio / Luminaire luminous flux 1875lm 2700K Ra>90 220-240V AC dimmable (DALI/Push DIM) IP40	1,18
	L12701.010.0402 L12702.010.0402 L12705.010.0402 L12717.010.0402 L12719.010.0402 L12727.010.0402 L12729.010.0402	Potenza assorbita apparecchio / Luminaire power consumption 16,4W Flusso luminoso apparecchio / Luminaire luminous flux 1913lm 3000K Ra>90 220-240V AC dimmable (DALI/Push DIM) IP40	1,18



Supporto lente obbligatorio non incluso, da acquistare separatamente. Mandatory lens holder not included, to be purchased separately.

YSL12701.010.FL YSL12702.010.FL YSL12705.010.FL YSL12717.010.FL YSL12719.010.FL YSL12727.010.FL YSL12729.010.FL	Supporto lente per 432 Ways, in alluminio, con verniciatura poliaccrilica in colore bianco, nero, champagne, bronzo, ottone satinato, verde oliva materico o terracotta naturale materico. Lens holder for 432 Ways, in aluminium, with polyacrylic paint finish in white, black, champagne, bronze, matte brass, textured olive green or textured natural terracotta.	0,25
--	---	------

Fotometrie disponibili www.panzeri.it / Photometric data available at www.panzeri.it

CODICI COLORI DISPONIBILI / COLOUR CODES AVAILABLE

01 bianco white	02 nero black	05 champagne champagne	17 bronzo bronze	19 ottone satinato matte brass	27 verde oliva materico textured olive green	29 terracotta naturale materico textured natural terracotta
---------------------------	-------------------------	----------------------------------	----------------------------	--	--	---





Adamas celebra l'arte del vetro, le tecniche di lavorazione artigianale, la cura e l'attenzione alla qualità. Nasce una forma iconica e avvolgente che con la luce caratterizza l'ambiente, attraverso le sfumature morbide del vetro soffiato e i riflessi mutevoli della texture geometrica realizzata a mano. Il diffusore, disponibile nelle cromie bronzo, fumé, verde foresta e rosa, nasconde al suo interno una sorgente LED che indirizza il fascio luminoso verso il basso, generando un suggestivo gioco di riflessi. Le versioni a sospensione con rosone, da tavolo e terra abbinano alle colorazioni del vetro strutture metalliche in finitura nero satinato e ottone satinato.

Adamas celebrates the art of glass, craftsmanship, care and attention to quality. The result is an iconic and enveloping shape that characterises the environment with light, through the soft shades of blown glass and the changing reflections of the handmade geometric texture. The diffuser, available in bronze, smoke grey, forest green and pink, conceals within it a LED source with a downwards light beam, generating an evocative play of reflections. The suspension, table and floor versions combine the glass colours with metal structures in matte black and matte brass finishes.

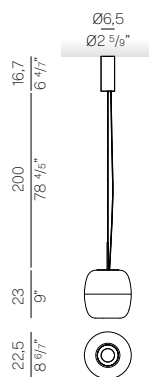

-  **L18106.023.0502**
L18119.023.0502
- L18206.023.0502**
L18219.023.0502
- L18306.023.0502**
L18319.023.0502
- L18406.023.0502**
L18419.023.0502

CODICE CODE	FONTI LUMINOSE LIGHT SOURCES	kg
L18106.023.0502 L18119.023.0502	vetro bronzo / bronze glass	3,70
L18206.023.0502 L18219.023.0502	vetro fumé / smoke grey glass	
L18306.023.0502 L18319.023.0502	vetro verde foresta / forest green glass	
L18406.023.0502 L18419.023.0502	vetro rosa / pink glass	

Potenza assorbita apparecchio / Luminaire power consumption 11W
 Flusso luminoso apparecchio / Luminaire luminous flux 746lm
 2700K Ra>90 220-240V AC dimmable (DALI/Push DIM)

 IP20

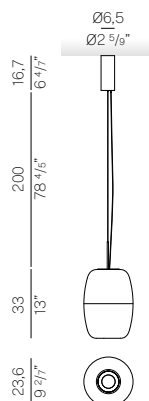

-  **L18106.033.0502**
L18119.033.0502
- L18206.033.0502**
L18219.033.0502
- L18306.033.0502**
L18319.033.0502
- L18406.033.0502**
L18419.033.0502

L18106.033.0502 L18119.033.0502	vetro bronzo / bronze glass	4,90
L18206.033.0502 L18219.033.0502	vetro fumé / smoke grey glass	
L18306.033.0502 L18319.033.0502	vetro verde foresta / forest green glass	
L18406.033.0502 L18419.033.0502	vetro rosa / pink glass	

Potenza assorbita apparecchio / Luminaire power consumption 11W
 Flusso luminoso apparecchio / Luminaire luminous flux 746lm
 2700K Ra>90 220-240V AC dimmable (DALI/Push DIM)

 IP20

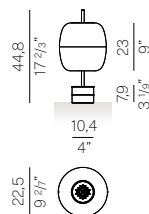

-  **C18106.023.0527**
C18119.023.0527
- C18206.023.0527**
C18219.023.0527
- C18306.023.0527**
C18319.023.0527
- C18406.023.0527**
C18419.023.0527

C18106.023.0527 C18119.023.0527	vetro bronzo / bronze glass	6,70
C18206.023.0527 C18219.023.0527	vetro fumé / smoke grey glass	
C18306.023.0527 C18319.023.0527	vetro verde foresta / forest green glass	
C18406.023.0527 C18419.023.0527	vetro rosa / pink glass	

Potenza assorbita apparecchio / Luminaire power consumption 11W
 Flusso luminoso apparecchio / Luminaire luminous flux 746lm
 2700K Ra>90 220-240V AC dimmable (Push DIM)

 IP20

Fornito completo di dimmer a sfioramento e cavo di alimentazione in tessuto nero
 Supplied with dimmer touch and black fabric power cable

ADAMAS

Enzo Panzeri 2025

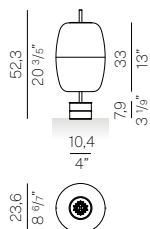

**CODICE
CODE**

**FONTI LUMINOSE
LIGHT SOURCES**

kg

C18106.033.0527

vetro bronzo / bronze glass

7,50

C18119.033.0527

C18206.033.0527

vetro fumé / smoke grey glass

C18219.033.0527

C18306.033.0527

vetro verde foresta / forest green glass

C18319.033.0527

C18406.033.0527

vetro rosa / pink glass

C18419.033.0527

Potenza assorbita apparecchio / Luminaire power consumption 11W
Flusso luminoso apparecchio / Luminaire luminous flux 746lm
2700K Ra>90 220-240V AC dimmable (Push DIM)

IP20

Fornito completo di dimmer a sfioramento e cavo di alimentazione in tessuto nero
Supplied with dimmer touch and black fabric power cable

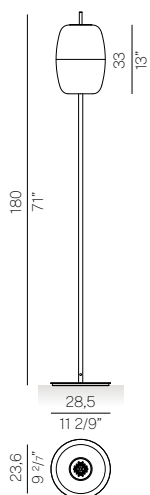

T18106.033.0527

vetro bronzo / bronze glass

10,00

T18119.033.0527

T18206.033.0527

vetro fumé / smoke grey glass

T18219.033.0527

T18306.033.0527

vetro verde foresta / forest green glass

T18319.033.0527

T18406.033.0527

vetro rosa / pink glass

T18419.033.0527

Potenza assorbita apparecchio / Luminaire power consumption 11W
Flusso luminoso apparecchio / Luminaire luminous flux 746lm
2700K Ra>90 220-240V AC dimmable (Push DIM)

IP20

Fornito completo di interruttore push e cavo di alimentazione in tessuto nero
Supplied with push switch and black fabric power cable

Fotometrie disponibili www.panzeri.it / Photometric data available at www.panzeri.it

CODICI COLORI DISPONIBILI / COLOUR CODES AVAILABLE

COLORE VETRI / GLASSES COLOUR

06 nero satinato
matte black

19 ottone satinato
matte brass

181 bronzo
bronze

182 fumé
smoke grey

183 verde foresta
forest green









184 rosa
pink





Lampada da parete in profilato di alluminio estruso. Sorgente luminosa composta da 1 modulo LED o 2 moduli LED a tensione di rete (220V). Modulo LED equipaggiato con speciale protezione da sovratensioni e coperchio di protezione trasparente. Dimmerazione possibile attraverso apposito variatore di luce (non incluso). Finitura con vernice poliaccrilica bianca, ottone satinato o spazzolato e verniciato color titanio. Fissaggio con grani laterali a scomparsa. Ideale per corridoi o uso residenziale.

Wall lamp in extruded aluminium. Lighting source made of 1 LED module or 2 LED modules to mains voltage (220V). LED module equipped with special protection from power surges and transparent cover. Possible dimming with specific dimmer (not included) – available as accessory. White or matte brass polyacrylic paint or brushed and painted in titanium colour. Fixing with hidden lateral grub screw. Ideal for corridors or residential use.

CODICE CODE	FONTI LUMINOSE LIGHT SOURCES	kg
 A09801.001.0506 A09819.001.0506 A09830.001.0506	Potenza assorbita apparecchio / Luminaire power consumption 18W Flusso luminoso apparecchio / Luminaire luminous flux 1431lm 2700K Ra>90 220-240V AC ON-OFF  IP20	1,00
 A09801.001.0406 A09819.001.0406 A09830.001.0406	Potenza assorbita apparecchio / Luminaire power consumption 18W Flusso luminoso apparecchio / Luminaire luminous flux 1431lm 3000K Ra>90 220-240V AC ON-OFF  IP20	1,00
 A09801.002.0506 A09819.002.0506 A09830.002.0506	Potenza assorbita apparecchio / Luminaire power consumption 36W Flusso luminoso apparecchio / Luminaire luminous flux 2862lm 2700K Ra>90 220-240V AC ON-OFF  IP20	2,03
 A09801.002.0406 A09819.002.0406 A09830.002.0406	Potenza assorbita apparecchio / Luminaire power consumption 36W Flusso luminoso apparecchio / Luminaire luminous flux 2862lm 3000K Ra>90 220-240V AC ON-OFF  IP20	2,03

YCO.D230.A04

Dispositivo dimmerabile per moduli LED a 230V, max 0,5A - 115W
Dimmable device for 230V LED modules, max 0,5A - 115W..

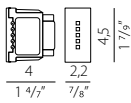
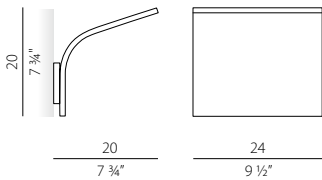
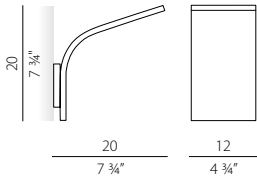

Fotometrie disponibili www.panzeri.it / Photometric data available at www.panzeri.it

CODICI COLORI DISPONIBILI / COLOUR CODES AVAILABLE

01 bianco white **19** ottone satinato matte brass **30** titanio titanium





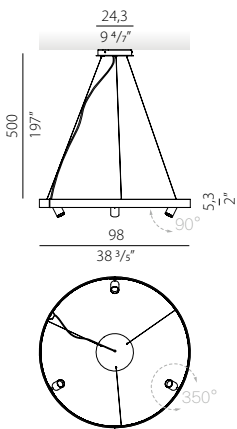

Lampada a sospensione in alluminio estruso curvato con schermo in policarbonato opale e spot orientabili. Linea interna luminosa e spot dimmerabili in tutte le versioni con tecnologia DALI/Push DIM. Finitura in vernice poliaccrilica color bianco, nero, titanio, bronzo e ottone satinato. Possibili colori custom su richiesta. Ideale per hall, zone living, retail e grandi spazi.

Suspension lamp in extruded curved aluminium with opal polycarbonate screen and adjustable spots. Dimmable interior light line and spots on all versions with DALI/Push DIM technology. White, black, titanium, bronze and matte brass finishes are available. Custom colors are available on request. Ideal for halls, living areas, retail and large spaces.





-  **L07401.100.0502**
- L07402.100.0502**
- L07417.100.0502**
- L07419.100.0502**
- L07430.100.0502**

CODICE CODE	FONTI LUMINOSE LIGHT SOURCES	kg
	Potenza assorbita apparecchio / Luminaire power consumption 92W	4,82
	Flusso luminoso apparecchio / Luminaire luminous flux 6732lm 2700K Ra>90 30° 220-240V AC dimmable (DALI/Push DIM)	
	 IP20	
	Fornito con n.3 M79D per eventuale decentramento del rosone Supplied with n.3 M79D for possible reposition of canopy	

-  **L07401.100.0402**
- L07402.100.0402**
- L07417.100.0402**
- L07419.100.0402**
- L07430.100.0402**

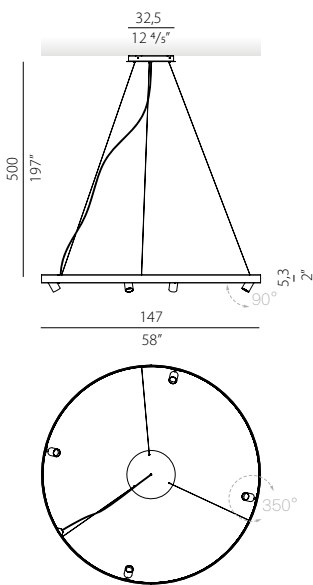
	Potenza assorbita apparecchio / Luminaire power consumption 92W	4,82
	Flusso luminoso apparecchio / Luminaire luminous flux 6732lm 3000K Ra>90 30° 220-240V AC dimmable (DALI/Push DIM)	
	 IP20	
	Fornito con n.3 M79D per eventuale decentramento del rosone Supplied with n.3 M79D for possible reposition of canopy	



-  **L07401.150.0502**
- L07402.150.0502**
- L07417.150.0502**
- L07419.150.0502**
- L07430.150.0502**

	Potenza assorbita apparecchio / Luminaire power consumption 129W	7,52
	Flusso luminoso apparecchio / Luminaire luminous flux 9675lm 2700K Ra>90 30° 220-240V AC dimmable (DALI/Push DIM)	
	 IP20	
	Fornito con n.3 M79D per eventuale decentramento del rosone Supplied with n.3 M79D for possible reposition of canopy	

-  **L07401.150.0402**
- L07402.150.0402**
- L07417.150.0402**
- L07419.150.0402**
- L07430.150.0402**

	Potenza assorbita apparecchio / Luminaire power consumption 129W	7,52
	Flusso luminoso apparecchio / Luminaire luminous flux 9675lm 3000K Ra>90 30° 220-240V AC dimmable (DALI/Push DIM)	
	 IP20	
	Fornito con n.3 M79D per eventuale decentramento del rosone Supplied with n.3 M79D for possible reposition of canopy	

ARENA

Enzo Panzeri 2020

	CODICE CODE	FONTI LUMINOSE LIGHT SOURCES	kg
	L07401.200.0502 L07402.200.0502 L07417.200.0502 L07419.200.0502 L07430.200.0502	Potenza assorbita apparecchio / Luminaire power consumption 154W Flusso luminoso apparecchio / Luminaire luminous flux 12618lm 2700K Ra>90 30° 220-240V AC dimmable (DALI/Push DIM) LED IP20 Fornito con n.4 M79D per eventuale decentramento del rosone Supplied with n.4 M79D for possible reposition of canopy	8,80
	L07401.200.0402 L07402.200.0402 L07417.200.0402 L07419.200.0402 L07430.200.0402	Potenza assorbita apparecchio / Luminaire power consumption 154W Flusso luminoso apparecchio / Luminaire luminous flux 12618lm 3000K Ra>90 30° 220-240V AC dimmable (DALI/Push DIM) LED IP20 Fornito con n.4 M79D per eventuale decentramento del rosone Supplied with n.4 M79D for possible reposition of canopy	8,80

Fotometrie disponibili www.panzeri.it / Photometric data available at www.panzeri.it

CODICI COLORI DISPONIBILI / COLOUR CODES AVAILABLE

01 bianco white **02** nero black **17** bronzo bronze **19** ottone satinato matte brass **30** titanio titanium





Lampada da sospensione, tavolo e parete (disponibile anche a incasso) con testa in pressofusione di alluminio. Diffusore in materiale acrilico con perimetro luminoso. Braccio conico decentrato, testa orientabile e comando Step DIM a 5 regolazioni di intensità luminosa caratterizzano le versioni da tavolo e parete, quest'ultima con snodo anche alla base, per una maggiore flessibilità nel posizionamento. La versione a sospensione, testa fissa e con tige centrale è disponibile in versione a emissione diretta e indiretta. Disponibile paralume in tessuto color avorio "Bella vestita" disegnato da Matteo Thun, da ordinare separatamente. Bianco, nero, champagne, titanio, bronzo e ottone satinato le finiture disponibili.

Suspension, table and wall lamp (also available recessed) with die-cast aluminium head. Diffuser in acrylic material with luminous perimeter. Decentralized conical arm, adjustable head and technology Step DIM with 5 intensity of light settings characterize the table and wall versions, the latter also with a joint at the base, for a higher positioning flexibility. The suspension version has a fixed head with central tige, is available in direct and indirect light versions. Ivory fabric lampshade "Bella vestita" designed by Matteo Thun is available, to order separately. White, black, champagne, titanium, bronze and matte brass finishes are available.

	CODICE CODE	FONTE LUMINOSE LIGHT SOURCES	kg
<p>Technical drawing showing dimensions: Ø 5,5, Ø 2 1/8", 13, 5 1/8", 300, 118 1/2", 10,1, 4", 1,3, 1/2", 14, 5 1/2".</p>	L05201.011.0501	Potenza assorbita apparecchio / Luminaire power consumption 6,5W	0,55
	L05202.011.0501	Flusso luminoso apparecchio / Luminaire luminous flux 388lm	
	L05205.011.0501	2700K Ra>90 220-240V AC ON-OFF	
	L05217.011.0501	IP40	
	L05219.011.0501		
<p>Technical drawing showing dimensions: Ø 5,5, Ø 2 1/8", 13, 5 1/8", 300, 118 1/2", 10,1, 4", 1,3, 1/2", 14, 5 1/2".</p>	L05201.011.0401	Potenza assorbita apparecchio / Luminaire power consumption 6,5W	0,55
	L05202.011.0401	Flusso luminoso apparecchio / Luminaire luminous flux 388lm	
	L05205.011.0401	3000K Ra>90 220-240V AC ON-OFF	
	L05217.011.0401	IP40	
	L05219.011.0401		
<p>Technical drawing showing dimensions: Ø 5,5, Ø 2 1/8", 13, 5 1/8", 300, 118 1/2", 10,1, 4", 1,3, 1/2", 14, 5 1/2".</p>	L05301.011.0501	Potenza assorbita apparecchio / Luminaire power consumption 6,5W	0,55
	L05302.011.0501	Flusso luminoso apparecchio / Luminaire luminous flux 388lm	
	L05305.011.0501	2700K Ra>90 220-240V AC ON-OFF	
	L05317.011.0501	IP40	
	L05319.011.0501		
<p>Technical drawing showing dimensions: Ø 5,5, Ø 2 1/8", 13, 5 1/8", 300, 118 1/2", 10,1, 4", 1,3, 1/2", 14, 5 1/2".</p>	L05301.011.0401	Potenza assorbita apparecchio / Luminaire power consumption 6,5W	0,55
	L05302.011.0401	Flusso luminoso apparecchio / Luminaire luminous flux 388lm	
	L05305.011.0401	3000K Ra>90 220-240V AC ON-OFF	
	L05317.011.0401	IP40	
	L05319.011.0401		
<p>Technical drawing showing dimensions: Ø 5,5, Ø 2 1/8", 13, 5 1/8", 300, 118 1/2", 10,1, 4", 1,3, 1/2", 14, 5 1/2".</p>	M05201.011.0510	Potenza assorbita apparecchio / Luminaire power consumption 4,5W	0,22
	M05202.011.0510	Flusso luminoso apparecchio / Luminaire luminous flux 388lm	
	M05205.011.0510	2700K Ra>90 24V DC	
	M05217.011.0510	IP40	
	M05219.011.0510	Fornito senza rosone e driver, per composizioni multiple	
<p>Technical drawing showing dimensions: Ø 5,5, Ø 2 1/8", 13, 5 1/8", 300, 118 1/2", 10,1, 4", 1,3, 1/2", 14, 5 1/2".</p>	M05201.011.0410	Potenza assorbita apparecchio / Luminaire power consumption 4,5W	0,22
	M05202.011.0410	Flusso luminoso apparecchio / Luminaire luminous flux 388lm	
	M05205.011.0410	3000K Ra>90 24V DC	
	M05217.011.0410	IP40	
	M05219.011.0410	Fornito senza rosone e driver, per composizioni multiple	
<p>Technical drawing showing dimensions: Ø 5,5, Ø 2 1/8", 13, 5 1/8", 300, 118 1/2", 10,1, 4", 1,3, 1/2", 14, 5 1/2".</p>	M05301.011.0510	Potenza assorbita apparecchio / Luminaire power consumption 4,5W	0,22
	M05302.011.0510	Flusso luminoso apparecchio / Luminaire luminous flux 388lm	
	M05305.011.0510	2700K Ra>90 24V DC	
	M05317.011.0510	IP40	
	M05319.011.0510	Fornito senza rosone e driver, per composizioni multiple	
<p>Technical drawing showing dimensions: Ø 5,5, Ø 2 1/8", 13, 5 1/8", 300, 118 1/2", 10,1, 4", 1,3, 1/2", 14, 5 1/2".</p>	M05301.011.0410	Potenza assorbita apparecchio / Luminaire power consumption 4,5W	0,22
	M05302.011.0410	Flusso luminoso apparecchio / Luminaire luminous flux 388lm	
	M05305.011.0410	3000K Ra>90 24V DC	
	M05317.011.0410	IP40	
	M05319.011.0410	Fornito senza rosone e driver, per composizioni multiple	
	M05330.011.0410	Supplied without canopy and driver, for multiple configurations	

BELLA

Enzo Panzeri 2019/2020

Registered Design

	CODICE CODE	FONTI LUMINOSE LIGHT SOURCES	kg
	C05201.011.0509	Potenza assorbita apparecchio / Luminaire power consumption 5W	0,88
	C05202.011.0509	Flusso luminoso apparecchio / Luminaire luminous flux 388lm	
	C05205.011.0509	2700K Ra>90 220-240V AC dimmable (Step DIM)	
	C05217.011.0509	IP20	
	C05219.011.0509	Interruttore incluso	
	C05230.011.0509	Switch included	
	A05201.011.0509	Potenza assorbita apparecchio / Luminaire power consumption 5W	0,56
	A05202.011.0509	Flusso luminoso apparecchio / Luminaire luminous flux 388lm	
	A05205.011.0509	2700K Ra>90 220-240V AC dimmable (Step DIM)	
	A05217.011.0509	IP20	
	A05219.011.0509	Interruttore incluso	
	A05230.011.0509	Switch included	
	A05201.011.0409	Potenza assorbita apparecchio / Luminaire power consumption 5W	0,56
	A05202.011.0409	Flusso luminoso apparecchio / Luminaire luminous flux 388lm	
	A05205.011.0409	3000K Ra>90 220-240V AC dimmable (Step DIM)	
	A05217.011.0409	IP20	
	A05219.011.0409	Interruttore incluso	
	A05230.011.0409	Switch included	
	X05201.011.0509	Potenza assorbita apparecchio / Luminaire power consumption 5W	0,93
	X05202.011.0509	Flusso luminoso apparecchio / Luminaire luminous flux 388lm	
	X05205.011.0509	2700K Ra>90 220-240V AC dimmable (Step DIM)	
	X05217.011.0509	IP20	
	X05219.011.0509	Interruttore incluso	
	X05230.011.0509	Switch included	
	X05201.011.0409	Potenza assorbita apparecchio / Luminaire power consumption 5W	0,93
	X05202.011.0409	Flusso luminoso apparecchio / Luminaire luminous flux 388lm	
	X05205.011.0409	3000K Ra>90 220-240V AC dimmable (Step DIM)	
	X05217.011.0409	IP20	
	X05219.011.0409	Interruttore incluso	
	X05230.011.0409	Switch included	
	YPL05207.015	Design Matteo Thun 2020 Paralume in tessuto plissé colore avorio, semplice installazione a scatto. Ivory pleated fabric lampshade, simple snap installation.	0,08

ROSONI E DECENTRAMENTI A PAGINA 105 / OFFSET AND CANOPIES PAGE 105

VERSIONE PER BINARIO STREET A PAGINA 172 / STREET TRACK VERSION ON PAGE 172



reddot winner 2020

Fotometrie disponibili www.panzeri.it / Photometric data available at www.panzeri.it

CODICI COLORI DISPONIBILI / COLOUR CODES AVAILABLE

01 bianco white **02** nero black **05** champagne champagne **17** bronzo bronze **19** ottone satinato matte brass **30** titanio titanium





Bow è l'espressione della flessibilità, una sottile linea che si curva sulle pareti per creare nuove geometrie attraverso la forma e la luce. Il corpo in policarbonato estruso si presta per accogliere segmenti di luce che possono essere posizionati a piacimento lungo tutta la sua estensione, creando linee luminose continue oppure tratti alternati. Questa versatilità permette di poter giocare con l'architettura disegnando linee rette buie e curve luminose. Bow può essere accorciato a piacimento e installato sia singolarmente che in configurazioni lineari composte da più moduli. Disponibile nelle finiture nero e legno. Una serie di accessori completa la famiglia per permettere di personalizzare l'installazione e l'illuminazione.



Bow is the expression of flexibility, a thin line that curves around the walls to create new geometries through shape and light. The extruded polycarbonate body lends itself to accommodate segments of light that can be positioned at will along its entire extension, creating continuous light lines or alternating strokes. This versatility makes it possible to play with the architecture by drawing straight dark lines and bright curves. Bow could be cut and installed either singly or in linear configurations composed of several modules. Available in black and wood finishes. A series of accessories completes the family to allow customised installation and lighting.

	CODICE CODE	FONTI LUMINOSE LIGHT SOURCES	kg
	 <p>A13806.302.0010 A13883.302.0010</p>	<p>Profilo elettrificato flessibile. Alimentazione 24V DC. Flexible electrified profile. Power supply 24V DC.</p> <p>IP20 </p> <p>Completo di n.2 box di fissaggio e kit di alimentazione. LED e driver non inclusi. Complete with 2 fixing boxes and power supply kit. LED and driver not included.</p>	0,48
	 <p>A13806.303.0010 A13883.303.0010</p>	<p>Profilo elettrificato flessibile. Alimentazione 24V DC. Flexible electrified profile. Power supply 24V DC.</p> <p>IP20 </p> <p>Completo di n.3 box di fissaggio e kit di alimentazione. LED e driver non inclusi. Complete with 3 fixing boxes and power supply kit. LED and driver not included.</p>	0,62
	 <p>A13806.304.0010 A13883.304.0010</p>	<p>Profilo elettrificato flessibile. Alimentazione 24V DC. Flexible electrified profile. Power supply 24V DC.</p> <p>IP20 </p> <p>Completo di n.4 box di fissaggio e kit di alimentazione. LED e driver non inclusi. Complete with 4 fixing boxes and power supply kit. LED and driver not included.</p>	0,72

BOW

Maurizio Quargnale 2023

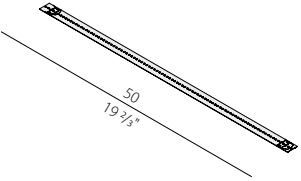
Registered Design

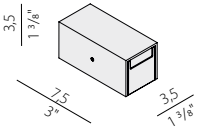
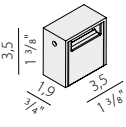
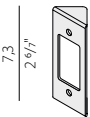
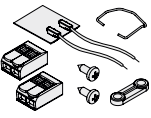
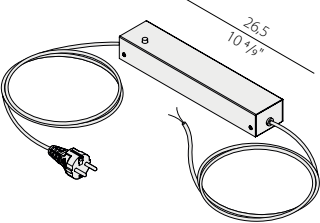
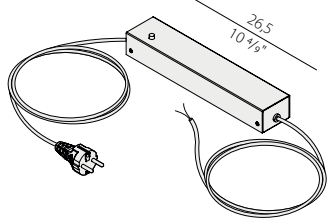
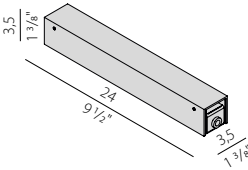
	CODICE CODE	FONTI LUMINOSE LIGHT SOURCES	kg
	YLB138.050.0510	Modulo LED, 500mm (19,7") 98 LED 8W 24V DC 2700K Ra>90 800lm. LED module, 500mm (19,7") 98 LED 8W 24V DC 2700K Ra>90 800lm.   Completo di n.2 molle di fissaggio. Sezionabile ogni 250mm. Complete with no. 2 fixing springs. Cuttable every 250 mm.	0,01
	YBF13806.007 YBF13883.007	Box di fissaggio in alluminio pressofuso con cover di chiusura in alluminio estruso per profilo Bow, con finitura in colore nero satinato o legno. Die-cast aluminium fastening box with extruded aluminium end cover for Bow profile, in matte black or wood finish.	0,12
	YFL13806.002 YFL13883.002	Distanziale per tratti lineari illuminati Bow, in alluminio, in finitura colore nero satinato e legno. Spacer for illuminated linear sections for Bow, made of aluminium, with matte black and wood finish.	0,04
	YFA13806.90 YFA13883.90	Staffa per fissaggio Bow in angolo a 90°, in acciaio con verniciatura poliaccrilica in colore nero satinato o per versione legno. Bracket for fixing Bow at 90° angle, made of steel with polyacrylic paint finish in matte black or for wood version. Utilizzare n.1 staffa per ogni box di fissaggio Use no. 1 bracket for each fixing box	0,02
	YKA13800.01	Kit per alimentazione supplementare per composizioni multiple, costituito da scheda alimentazione 24V con n.1 molla di fissaggio, bloccacavo, cavi di alimentazione, morsetti. Additional power supply kit for multiple configurations, consisting of 24V power supply board with 1 fixing spring, cable clamp, power supply cables, terminals blocks.	0,01
	YCD13806.300.060	Box di alimentazione per Bow, con driver 60W/24V, con dimmer integrato e spina. Lunghezza 3m (118 1/5"). Power supply box for Bow, with 60W/24V driver, with integrated dimmer and plug. Length 3m (118 1/5").	1,14
	YCI13806.300.075	Box di alimentazione per Bow, con driver 75W/24V on/off, con pulsante e spina. Lunghezza 3m (118 1/5"). Power supply box for Bow, with 75W/24V on/off driver, with button and plug. Length 3m (118 1/5").	1,32
	YBA13806.060.A01 YBA13883.060.A01	Box di alimentazione integrato per Bow, con driver 60W/24V on/off Integrated power supply box for Bow, with driver 60W/24V on/off	0,47

Fotometrie disponibili www.panzeri.it / Photometric data available at www.panzeri.it

CODICI COLORI DISPONIBILI / COLOUR CODES AVAILABLE

06 nero satinato
matte black

83 legno
wood

L'Ufficio Tecnico Panzeri è disponibile a supporto della progettazione / Panzeri Technical Department is available to support the design



A138__304 n.1
 YLB138.050.0510 n.4
 YDV.024.060.A02 (remote) n.1

n.1 A138__304
 n.5 YLB138.050.0510
 n.1 YDV.024.060.A02 (remote)

n.1 A138__303
 n.2 YLB138.050.0510
 n.1 YBA138__060.A01

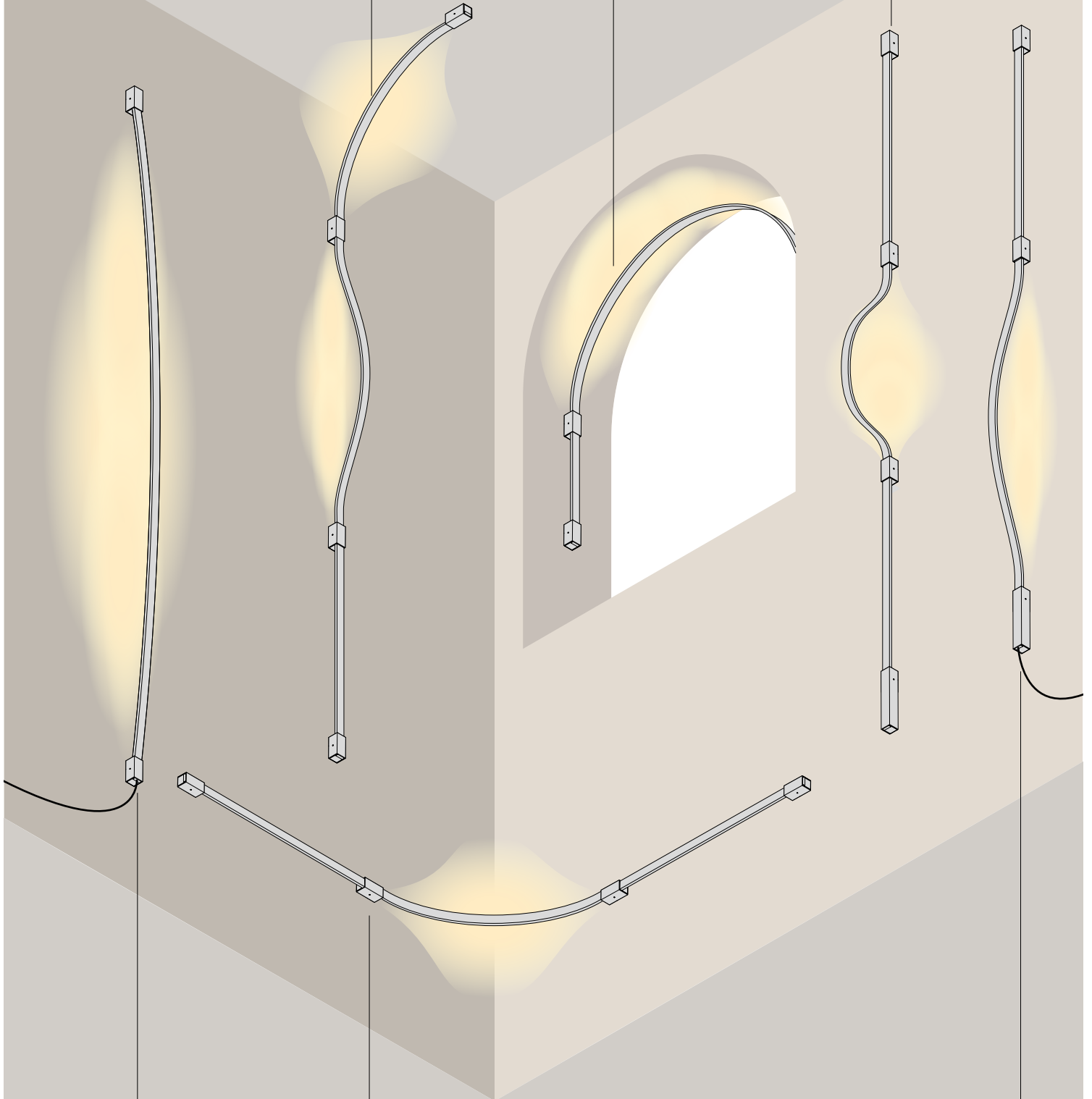

n.1 A138__302
 n.6 YLB138.050.0510
 n.1 YCD138__300.060

n.1 A138__304
 n.2 YLB138.050.0510
 n.1 YDV.024.035.A02 (remote)

A138__302 n.1
 YLB138.050.0510 n.3
 YBA138__060.A01 n.1



Suspensione a LED in alluminio estruso verniciato bianco, nero con riflettore e schermo.

Suspension LED in extruded aluminium, painted white, black with reflector and screen.

	CODICE CODE	FONTI LUMINOSE LIGHT SOURCES	kg
	L23301.100.0401	Potenza assorbita apparecchio / Luminaire power consumption 20W	2,12
	L23302.100.0401	Flusso luminoso apparecchio / Luminaire luminous flux 1142lm 3000K Ra>90 220-240V AC ON-OFF IP20 850° Fornito con diffusore opale e riflettore Supplied with opal diffuser and reflector	
	L23301.150.0401	Potenza assorbita apparecchio / Luminaire power consumption 29W	2,32
	L23302.150.0401	Flusso luminoso apparecchio / Luminaire luminous flux 1713lm 3000K Ra>90 220-240V AC ON-OFF IP20 850° Fornito con diffusore opale e riflettore Supplied with opal diffuser and reflector	
	L23301.200.0401	Potenza assorbita apparecchio / Luminaire power consumption 29W	2,32
	L23302.200.0401	Flusso luminoso apparecchio / Luminaire luminous flux 1713lm 3000K Ra>90 220-240V AC dimmable (DALI/Push DIM) IP20 850° Fornito con diffusore opale e riflettore Supplied with opal diffuser and reflector	
	YDM23301.100	Schermo diffusore in policarbonato estruso microprismato, di lunghezza 1024mm (40,3"). Micro-prismatic extruded polycarbonate diffuser, 1024mm (40,3") long.	
	YDM23301.150	Schermo diffusore in policarbonato estruso microprismato, di lunghezza 1524mm (60"). Micro-prismatic extruded polycarbonate diffuser, 1524mm (60") long.	
	YDM23301.200	Schermo diffusore in policarbonato estruso microprismato, di lunghezza 2024mm (79,7"). Micro-prismatic extruded polycarbonate diffuser, 2024mm (79,7") long.	

Fotometrie disponibili www.panzeri.it / Photometric data available at www.panzeri.it

CODICI COLORI DISPONIBILI / COLOUR CODES AVAILABLE

- 01** bianco / white
- 02** nero / black



BROOKLYN ROUND

Enzo Panzeri 2017



Lampada a sospensione e soffitto/parete in alluminio estruso curvato con schermo in policarbonato opale. Sorgente luminosa composta da modulo led a luce diretta e dimmerazione inserita nel rosone. Finitura con vernice poliacrilica in bianco, nero o ottone satinato e dettaglio del profilo a coste. Disponibile rosone per composizioni multiple di Brooklyn Round. Ideale per uffici, hall, zone living, grandi spazi.

Suspension and ceiling/wall lamp in extruded curved aluminum with opal polycarbonate screen. Light source made of LED module with direct light and dimmable driver in the canopy. Polyacrylic white, black or matte brass painted and ribbed lateral finish. Canopy for multiple configurations of Brooklyn Round is available. Ideal for offices, hall, living areas, and large areas.

	CODICE CODE	FONTI LUMINOSE LIGHT SOURCES	kg
	L23101.360.0402 L23102.360.0402 L23119.360.0402	Potenza assorbita apparecchio / Luminaire power consumption 55W Flusso luminoso apparecchio / Luminaire luminous flux 2965lm 3000K Ra>90 220-240V AC dimmable (DALI/Push DIM) IP40 850°	3,24
	L23201.360.0402 L23202.360.0402 L23219.360.0402	Potenza assorbita apparecchio / Luminaire power consumption 109W Flusso luminoso apparecchio / Luminaire luminous flux 5931lm 3000K Ra>90 220-240V AC dimmable (DALI/Push DIM) IP40 850°	5,78
	L23101.180.0402 L23102.180.0402 L23119.180.0402	Potenza assorbita apparecchio / Luminaire power consumption 29W Flusso luminoso apparecchio / Luminaire luminous flux 1483lm 3000K Ra>90 220-240V AC dimmable (DALI/Push DIM) IP40 850°	1,89
	L23201.180.0402 L23202.180.0402 L23219.180.0402	Potenza assorbita apparecchio / Luminaire power consumption 55W Flusso luminoso apparecchio / Luminaire luminous flux 2965lm 3000K Ra>90 220-240V AC dimmable (DALI/Push DIM) IP40 850°	3,38
	XM231/23201L XM231/23202L XM231/23219L	Piastrina per sospensioni multiple. Plate for multiple suspensions.	0,03

ROSONI BROOKLYN ROUND / BROOKLYN ROUND CANOPIES



Rosone per composizioni multiple di Brooklyn Round. Può alloggiare al suo interno un numero massimo di 4 driver di diverse potenze, da 4x60W/24V DALI / PUSH DIM a 2x60W/24V+2x200W/24V DALI / PUSH DIM. Gli apparecchi Brooklyn Round vanno ordinati senza rosone e driver. L'Ufficio Tecnico Panzeri è disponibile a supporto della progettazione.

Canopy for Brooklyn Round configurations. It carries a maximum of 4 drivers of different power: from 4 x60W/24V DALI / PUSH DIM to 2x60W/24V+2x200W/24V DALI / PUSH DIM. Brooklyn Round fixtures have to be ordered without canopy and driver. Panzeri Technical Department is available to support the design.

CODICE CODE	FONTI LUMINOSE LIGHT SOURCES	kg
XM23101.538.0099	Rosone per collegamento elettrico con 8	1,17
XM23102.538.0099	uscite e per raggruppamento di 7 funi in	
XM23119.538.0099	acciaio, per massimo 8 modelli Brooklyn Round.	
	Canopy for power supply with 8 outputs and to join 7 steel cables, for up to 8 Brooklyn Round models maximum.	

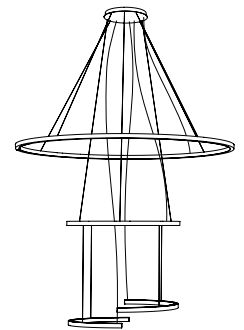
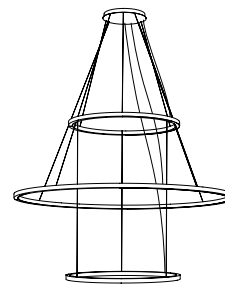
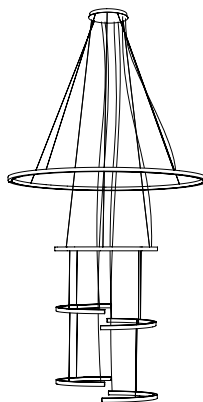
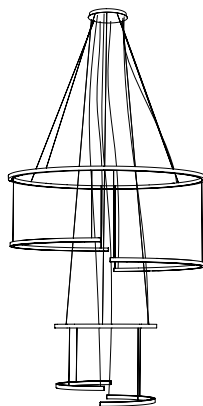
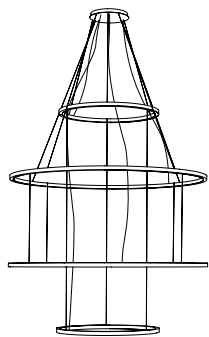
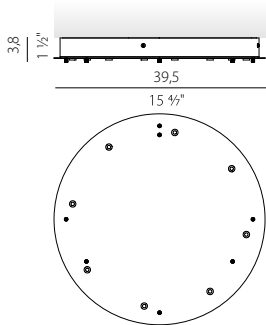

01 Esempio di composizione con 4 apparecchi:
Example of configuration with 4 fixtures:
N. 1 canopy
XM231__538.0099
N.2 Brooklyn Round
L232__360.0402 SPECIAL
N.2 Brooklyn Round
L231__360.0402 SPECIAL
N.7 XM231/232__L

02 Esempio di composizione con 6 apparecchi:
Example of configuration with 6 fixtures:
N. 1 canopy XM231__538.0099
N.1 Brooklyn Round
L232__360.0402 SPECIAL
N.2 Brooklyn Round
L232__180.0402 SPECIAL
N.1 Brooklyn Round
L231__360.0402 SPECIAL
N.2 Brooklyn Round
L231__180.0402 SPECIAL
N.10 XM231/232__L

03 Esempio di composizione con 6 apparecchi:
Example of configuration with 6 fixtures:
N. 1 canopy
XM231__538.0099
N.1 Brooklyn Round
L232__360.0402 SPECIAL
N.1 Brooklyn Round
L231__360.0402 SPECIAL
N.4 Brooklyn Round
L231__180.0402 SPECIAL
N.8 XM231/232__L

04 Esempio di composizione con 3 apparecchi:
Example of configuration with 3 fixtures:
N. 1 canopy
XM231__538.0099
N.1 Brooklyn Round
L232__360.0402 SPECIAL
N.2 Brooklyn Round
L231__360.0402 SPECIAL
N.3 XM231/232__L

05 Esempio di composizione con 4 apparecchi:
Example of configuration with 4 fixtures:
N. 1 canopy
XM231__538.0099
N.1 Brooklyn Round
L232__360.0402 SPECIAL
N.1 Brooklyn Round
L231__360.0402 SPECIAL
N.2 Brooklyn Round
L231__180.0402 SPECIAL
N.4 XM231/232__L

Fotometrie disponibili www.panzeri.it / Photometric data available at www.panzeri.it

CODICI COLORI DISPONIBILI / COLOUR CODES AVAILABLE

01 bianco white **02** nero black **19** ottone satinato matte brass

BROOKLYN ROUND

Enzo Panzeri 2017

	CODICE CODE	FONTI LUMINOSE LIGHT SOURCES	kg
	P23101.360.0402 P23102.360.0402 P23119.360.0402	Potenza assorbita apparecchio / Luminaire power consumption 55W Flusso luminoso apparecchio / Luminaire luminous flux 2965lm 3000K Ra>90 220-240V AC dimmable (DALI/Push DIM)	3,29
		IP40 850°	
	P23201.360.0402 P23202.360.0402 P23219.360.0402	Potenza assorbita apparecchio / Luminaire power consumption 109W Flusso luminoso apparecchio / Luminaire luminous flux 5931lm 3000K Ra>90 220-240V AC dimmable (DALI/Push DIM)	5,83
		IP40 850°	
	P23101.180.0402 P23102.180.0402 P23119.180.0402	Potenza assorbita apparecchio / Luminaire power consumption 29W Flusso luminoso apparecchio / Luminaire luminous flux 1483lm 3000K Ra>90 220-240V AC dimmable (DALI/Push DIM)	1,99
		IP40 850°	
	P23201.180.0402 P23202.180.0402 P23219.180.0402	Potenza assorbita apparecchio / Luminaire power consumption 55W Flusso luminoso apparecchio / Luminaire luminous flux 2965lm 3000K Ra>90 220-240V AC dimmable (DALI/Push DIM)	3,38
		IP40 850°	

Fotometrie disponibili www.panzeri.it / Photometric data available at www.panzeri.it

CODICI COLORI DISPONIBILI / COLOUR CODES AVAILABLE

Disponibili a richiesta LED 2700K / On request 2700K LED available

01 bianco
white

02 nero
black

19 ottone satinato
matte brass





CANDLE



Silvia Poma 2006





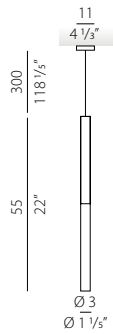

Lampada a sospensione costituita da rosone in metallo e vetro borosilicato filettato. Vetro satinato nella parte superiore e trasparente nella sezione inferiore. Emissione di luce diffusa generata da varie fonti luminose (modulo LED o G9). Rosone in metallo verniciato poliacrilico bianco customizzabile in colore, forma e dimensione. Ideale per lobby o grandi spazi residenziali.

Suspension lamp made of a metal canopy and threaded borosilicate glass. Frosted glass in the upper part and transparent in the lower section. Emission of diffused light provided by various light sources (LED module or G9). Metal canopy in white polyacrylic paint, customizable in color, shape and size. Ideal for lobby or large residential areas.

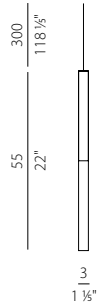

CODICE CODE	FONTI LUMINOSE LIGHT SOURCES	kg
 L09501.000.0401	Potenza assorbita apparecchio / Luminaire power consumption 4W Flusso luminoso apparecchio / Luminaire luminous flux 238lm 3000K Ra>90 220-240V AC ON-OFF  IP20	0,62
 L09501.000.0000	LED retrofit bulb G9 (L max 60mm - Ø max 17,5mm) max 48W G9 IP20	0,58



 M09501.000.0410	Potenza assorbita apparecchio / Luminaire power consumption 2,8W Flusso luminoso apparecchio / Luminaire luminous flux 238lm 3000K Ra>90 24V DC  IP20  Fornito senza rosone e driver, per composizioni multiple Supplied without canopy and driver, for multiple configurations	0,37
 M09501.000.0000	LED retrofit bulb G9 (L max 60mm - Ø max 17,5mm) max 48W G9 IP20 Fornito senza rosone, per composizioni multiple Supplied without canopy, for multiple configurations	0,37

Fotometrie disponibili www.panzeri.it / Photometric data available at www.panzeri.it

CODICI COLORI DISPONIBILI / COLOUR CODES AVAILABLE

01 bianco
white

ROSONI E DECENTRAMENTI A PAGINA 105 / OFFSET AND CANOPIES PAGE 105



La famiglia propone apparecchi installabili con rosone ad incasso nel soffitto, per applicazioni versatili che danno vita a geometrie di luce e volumi nello spazio. Disponibili in versione fissa oppure orientabile, sono adatti ad una grande varietà di applicazioni quali strutture ricettive, spazi residenziali, showroom e negozi. Il design sobrio e discreto, che permette di armonizzare stile e funzionalità, è arricchito dalla vasta gamma di finiture in colore bianco, nero, champagne, bronzo, ottone satinato e titanio. Progettati per ospitare i nuovi LED COB ad alta efficienza, offrono comfort visivo grazie allo snoot integrato nero e al vetro zigrinato di serie. Tutte le versioni sono fornite complete di driver.

Carl is a family of lighting fittings to install in the ceiling with a recessed canopy, for versatile applications that create geometries of light and volumes in the interior space. Available in a fixed or adjustable version, they suit a variety of applications amongst which reception halls, residential spaces, retail stores and show-rooms. The sober and discreet design enables to harmonize style and functionality, and is enriched by an extensive range of finishes in white, black, champagne, bronze, matte brass and titanium. Engineered to embed new high-efficiency COB LEDs, they provide visual comfort thanks to the integrated black snoot and to the prismatic spread lens. All versions are supplied with a power supply.

	CODICE CODE	FONTI LUMINOSE LIGHT SOURCES	kg
	X12201.008.1701	Potenza assorbita apparecchio / Luminaire power consumption 12W	0,27
	X12202.008.1701	Flusso luminoso apparecchio / Luminaire luminous flux 1050lm	
	X12205.008.1701	2700K Ra>90 30° 350mA DC ON-OFF	
	X12217.008.1701	IP20 850°	
	X12219.008.1701	Fornito completo di driver ON-OFF	
	X12230.008.1701	Supplied with ON-OFF driver	
	X12201.008.2501	Potenza assorbita apparecchio / Luminaire power consumption 12W	0,27
	X12202.008.2501	Flusso luminoso apparecchio / Luminaire luminous flux 1050lm	
	X12205.008.2501	3000K Ra>90 30° 350mA DC ON-OFF	
	X12217.008.2501	IP20 850°	
	X12219.008.2501	Fornito completo di driver ON-OFF	
	X12230.008.2501	Supplied with ON-OFF driver	
	X12301.007.1701	Potenza assorbita apparecchio / Luminaire power consumption 6,5W	0,11
	X12302.007.1701	Flusso luminoso apparecchio / Luminaire luminous flux 425lm	
	X12305.007.1701	2700K Ra>90 34° 700mA DC ON-OFF	
	X12317.007.1701	IP20 850°	
	X12319.007.1701	Fornito completo di driver ON-OFF	
	X12330.007.1701	Supplied with ON-OFF driver	
	X12301.007.2501	Potenza assorbita apparecchio / Luminaire power consumption 6,5W	0,11
	X12302.007.2501	Flusso luminoso apparecchio / Luminaire luminous flux 425lm	
	X12305.007.2501	3000K Ra>90 34° 700mA DC ON-OFF	
	X12317.007.2501	IP20 850°	
	X12319.007.2501	Fornito completo di driver ON-OFF	
	X12330.007.2501	Supplied with ON-OFF driver	
	X12301.010.1702	Potenza assorbita apparecchio / Luminaire power consumption 18W	0,29
	X12302.010.1702	Flusso luminoso apparecchio / Luminaire luminous flux 1436lm	
	X12305.010.1702	2700K Ra>90 30° 500mA DC dimmable (DALI/Push DIM)	
	X12317.010.1702	IP20 850°	
	X12319.010.1702	Fornito completo di driver DALI/Push DIM	
	X12330.010.1702	Supplied with DALI/Push DIM driver	
	X12301.010.2502	Potenza assorbita apparecchio / Luminaire power consumption 18W	0,29
	X12302.010.2502	Flusso luminoso apparecchio / Luminaire luminous flux 1436lm	
	X12305.010.2502	3000K Ra>90 30° 500mA DC dimmable (DALI/Push DIM)	
	X12317.010.2502	IP20 850°	
	X12319.010.2502	Fornito completo di driver DALI/Push DIM	
	X12330.010.2502	Supplied with DALI/Push DIM driver	

Fotometrie disponibili www.panzeri.it / Photometric data available at www.panzeri.it

UGR < 16 in funzione delle condizioni di installazione / UGR < 16 Depending on installation conditions

CODICI COLORI DISPONIBILI / COLOUR CODES AVAILABLE

01 bianco white **02** nero black **05** champagne champagne **17** bronzo bronze **19** ottone satinato matte brass **30** titanio titanium





Un segno caratteristico decorativo, attraverso il quale la precisione dell'orologeria ispira la lavorazione del vetro soffiato, dà vita a Côte, una collezione di apparecchi da soffitto, parete e sospensione per l'illuminazione indoor. Il ritmo regolare della superficie a coste dialoga sia con la luce emessa che con la luce naturale, rendendo Côte un elemento prezioso anche quando spento, un elegante segno distintivo degli ambienti in cui è inserito. La texture del vetro acidato, disponibile in finitura bianca e fumé, viene enfatizzata e proiettata dalla luce, con sfumature morbide e riflessi suggestivi.

A characteristic decorative mark, through which the precision of watchmaking inspires blown glass workmanship, gives life to Côte, a collection of ceiling, wall and suspension fixtures for indoor lighting. The regular rhythm of the ribbed surface dialogues with both the light emitted and the natural light, making Côte a precious element even when switched off, an elegant hallmark of the rooms in which it is placed. The texture of the frosted glass, available in white and smoke grey finishes, is emphasised and projected by the light, with soft nuances and suggestive reflections.

	CODICE CODE	FONTI LUMINOSE LIGHT SOURCES	kg	
	L06001.050.0504	vetro acidato bianco / Frosted white glass	5,60	
	L06002.050.0504			
	L06019.050.0504			
	L06101.050.0504	vetro acidato fumé / Smoky grey frosted glass		
	L06102.050.0504			
		Potenza assorbita apparecchio / Luminaire power consumption 22,5W Flusso luminoso apparecchio / Luminaire luminous flux 1815lm 2700K Ra>90 220-240V AC dimmable (phase cut) IP20		
	L06001.050.0404	vetro acidato bianco / Frosted white glass	5,60	
	L06002.050.0404			
	L06019.050.0404			
	L06101.050.0404	vetro acidato fumé / Smoky grey frosted glass		
	L06119.050.0404			
		Potenza assorbita apparecchio / Luminaire power consumption 22,5W Flusso luminoso apparecchio / Luminaire luminous flux 1870lm 3000K Ra>90 220-240V AC dimmable (phase cut) IP20		
	P06001.035.0504	vetro acidato bianco / Frosted white glass	3,40	
	P06101.035.0504	vetro acidato fumé / Smoky grey frosted glass		
		Potenza assorbita apparecchio / Luminaire power consumption 19W Flusso luminoso apparecchio / Luminaire luminous flux 1485lm 2700K Ra>90 220-240V AC dimmable (phase cut) IP20		
	P06001.035.0404	Vetro acidato bianco / Frosted white glass		3,40
	P06101.035.0404	Vetro acidato fumé / Smoky grey frosted glass		
		Potenza assorbita apparecchio / Luminaire power consumption 19W Flusso luminoso apparecchio / Luminaire luminous flux 1530lm 3000K Ra>90 220-240V AC dimmable (phase cut) IP20		
	P06001.050.0504	vetro acidato bianco / Frosted white glass	5,00	
	P06101.050.0504	vetro acidato fumé / Smoky grey frosted glass		
		Potenza assorbita apparecchio / Luminaire power consumption 22,5W Flusso luminoso apparecchio / Luminaire luminous flux 1815lm 2700K Ra>90 220-240V AC dimmable (phase cut) IP20		
	P06001.050.0404	vetro acidato bianco / Frosted white glass		5,00
	P06101.050.0404	vetro acidato fumé / Smoky grey frosted glass		
		Potenza assorbita apparecchio / Luminaire power consumption 22,5W Flusso luminoso apparecchio / Luminaire luminous flux 1870lm 3000K Ra>90 220-240V AC dimmable (phase cut) IP20		

Fotometrie disponibili www.panzeri.it / Photometric data available at www.panzeri.it

CODICI COLORI DISPONIBILI / COLOUR CODES AVAILABLE

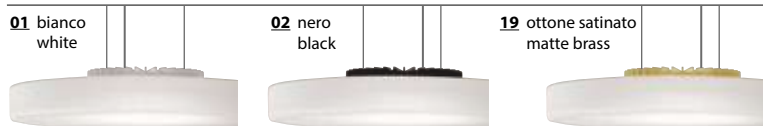

COLORE VETRI / GLASSES COLOUR

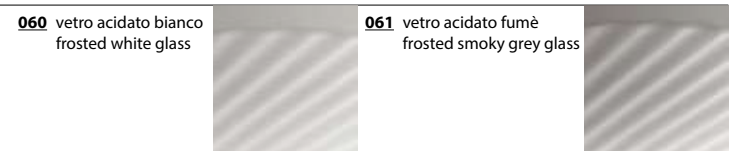



Lampada a parete in metallo tagliato a laser con diffusore in vetro acidato. Luce sia diretta che indiretta ottenuta da fonte luminosa LED. Fascia metallica rifinita con vernice poliaccrilica bianca, ottone satinato o con decorazione a mano in foglia oro e fissata alla struttura senza l'ausilio di viti a vista attraverso sistema elastico. Le fasce assemblate creano un simmetrico gioco di luci e ombre sulla struttura. Ideale per corridoi o uso residenziale.

Wall lamp in laser-cut metal and glass diffuser. Direct and indirect LED light. Metal cover in white or matte brass polyacrylic paint or hand-decorated with golden leaf and fixed without any visible screw thanks to an elastic system. The assembled covers create a symmetrical play of lights and shadows on the structure. Ideal for corridors or residential use.

	CODICE CODE	FONTI LUMINOSE LIGHT SOURCES	kg
	A04901.030.0101	Potenza assorbita apparecchio / Luminaire power consumption 20W	1,22
	A04919.030.0101	Flusso luminoso apparecchio / Luminaire luminous flux 2340lm	
	A04921.030.0101	3000K Ra>80 220-240V AC ON-OFF IP20	
	A04901.030.0102	Potenza assorbita apparecchio / Luminaire power consumption 20W	1,22
	A04919.030.0102	Flusso luminoso apparecchio / Luminaire luminous flux 2340lm	
	A04921.030.0102	3000K Ra>80 220-240V AC dimmable (DALI/Push DIM) IP20	
	A04901.060.0101	Potenza assorbita apparecchio / Luminaire power consumption 40W	2,32
	A04919.060.0101	Flusso luminoso apparecchio / Luminaire luminous flux 4680lm	
	A04921.060.0101	3000K Ra>80 220-240V AC ON-OFF IP20	
	A04901.060.0102	Potenza assorbita apparecchio / Luminaire power consumption 40W	2,32
	A04919.060.0102	Flusso luminoso apparecchio / Luminaire luminous flux 4680lm	
	A04921.060.0102	3000K Ra>80 220-240V AC dimmable (DALI/Push DIM) IP20	

Fotometrie disponibili www.panzeri.it / Photometric data available at www.panzeri.it

CODICI COLORI DISPONIBILI / COLOUR CODES AVAILABLE

Disponibili a richiesta LED 2700K / On request 2700K LED available

01 bianco
white

19 ottone satinato
matte brass

21 foglia oro
gold leaf





Con le sue versioni sospensione, parete, soffitto e terra indoor/outdoor, Dip porta la luce dove è necessario, valorizzando con classe ed eleganza ambienti residenziali e commerciali. Il design minimale degli apparecchi viene enfatizzato da un'accurata selezione di finiture specifiche per ogni tipologia di installazione che nella versione terra indoor, lavorano in abbinamento alla base in marmo nero marquina, travertino, rosso Lepanto o emperador dark. Versione da sospensione con cavo di alimentazione regolabile in altezza; versioni da terra, parete e soffitto caratterizzate da un braccio curvo che sostiene la testa orientabile, permettendo di scegliere la direzione del fascio luminoso.

Dip brings light to dedicated areas, enhancing residential and commercial environments with class and elegance thanks to suspension, wall, ceiling and floor indoor/outdoor versions. The minimalist design of the luminaires is emphasised by a careful selection of specific finishes for each type of installation which, in the floor-standing version for indoor use, are characterised by black Marquina marble, travertine, Lepanto red or Emperador Dark. Suspension version with height-adjustable power supply cable; floor, wall and ceiling versions characterized by a curved arm that supports the adjustable head, allowing to direction the light beam.

	CODICE CODE	FONTI LUMINOSE LIGHT SOURCES	kg
	T08517.170.0527 T08528.170.0527	Potenza assorbita apparecchio / Luminaire power consumption 18W Flusso luminoso apparecchio / Luminaire luminous flux 1931lm 2700K Ra>90 220-240V AC dimmable (Push DIM) LED IP40	17,00
	T08517.170.0427 T08528.170.0427	Potenza assorbita apparecchio / Luminaire power consumption 18W Flusso luminoso apparecchio / Luminaire luminous flux 1931lm 3000K Ra>90 220-240V AC dimmable (Push DIM) LED IP40 Base di appoggio in marmo travertino. Fornito completo di interruttore push, cavo 2,5m e spina Base in travertine marble. Supplied complete with push switch, 2,5m cable and plug	17,00
	T08605.170.0527 T08606.170.0527 T08617.170.0527	Potenza assorbita apparecchio / Luminaire power consumption 18W Flusso luminoso apparecchio / Luminaire luminous flux 1931lm 2700K Ra>90 220-240V AC dimmable (Push DIM) LED IP40	17,00
	T08605.170.0427 T08606.170.0427 T08617.170.0427	Potenza assorbita apparecchio / Luminaire power consumption 18W Flusso luminoso apparecchio / Luminaire luminous flux 1931lm 3000K Ra>90 220-240V AC dimmable (Push DIM) LED IP40 Base di appoggio in marmo nero marquina. Fornito completo di interruttore push, cavo 2,5m e spina Base in black marquina marble. Supplied complete with push switch, 2,5m cable and plug	17,00
	T08705.170.0527 T08717.170.0527 T08719.170.0527	Potenza assorbita apparecchio / Luminaire power consumption 18W Flusso luminoso apparecchio / Luminaire luminous flux 1931lm 2700K Ra>90 220-240V AC dimmable (Push DIM) LED IP40	17,00
	T08705.170.0427 T08717.170.0427 T08719.170.0427	Potenza assorbita apparecchio / Luminaire power consumption 18W Flusso luminoso apparecchio / Luminaire luminous flux 1931lm 3000K Ra>90 220-240V AC dimmable (Push DIM) LED IP40 Base di appoggio in marmo rosso Lepanto. Fornito completo di interruttore push, cavo 2,5m e spina Base in Lepanto red marble. Supplied complete with push switch, 2,5m cable and plug	17,00
	T08305.170.0527 T08317.170.0527 T08319.170.0527	Potenza assorbita apparecchio / Luminaire power consumption 18W Flusso luminoso apparecchio / Luminaire luminous flux 1931lm 2700K Ra>90 220-240V AC dimmable (Push DIM) LED IP40	17,00
	T08305.170.0427 T08317.170.0427 T08319.170.0427	Potenza assorbita apparecchio / Luminaire power consumption 18W Flusso luminoso apparecchio / Luminaire luminous flux 1931lm 3000K Ra>90 220-240V AC dimmable (Push DIM) LED IP40 Base di appoggio in marmo Emperador dark. Fornito completo di interruttore push, cavo 2,5m e spina Base in Emperador dark marble. Supplied complete with push switch, 2,5m cable and plug	17,00

DIP

Hangar Design Group 2024

Registered Design

	CODICE CODE	FONTI LUMINOSE LIGHT SOURCES	kg
	ET08416.170.0527 ET08427.170.0527 ET08428.170.0527 ET08434.170.0527	Potenza assorbita apparecchio / Luminaire power consumption 18W Flusso luminoso apparecchio / Luminaire luminous flux 1931lm 2700K Ra>90 220-240V AC dimmable (Push DIM) LED IP65	20,00
	Fornito completo di interruttore push, cavo 3m e spina Supplied complete with push switch, 3m cable and plug		
	ET08416.170.0427 ET08427.170.0427 ET08428.170.0427 ET08434.170.0427	Potenza assorbita apparecchio / Luminaire power consumption 18W Flusso luminoso apparecchio / Luminaire luminous flux 1931lm 3000K Ra>90 220-240V AC dimmable (Push DIM) LED IP65	20,00
	Fornito completo di interruttore push, cavo 3m e spina Supplied complete with push switch, 3m cable and plug		
	L08405.000.0502 L08406.000.0502 L08417.000.0502 L08428.000.0502	Potenza assorbita apparecchio / Luminaire power consumption 18W Flusso luminoso apparecchio / Luminaire luminous flux 1931lm 2700K Ra>90 220-240V AC dimmable (DALI/Push DIM) LED IP40	1,90
	Fornito completo di interruttore push, cavo 3m e spina Supplied complete with push switch, 3m cable and plug		
	L08405.000.0402 L08406.000.0402 L08417.000.0402 L08428.000.0402	Potenza assorbita apparecchio / Luminaire power consumption 18W Flusso luminoso apparecchio / Luminaire luminous flux 1931lm 3000K Ra>90 220-240V AC dimmable (DALI/Push DIM) LED IP40	1,90
	Fornito completo di interruttore push, cavo 3m e spina Supplied complete with push switch, 3m cable and plug		
	P08405.090.0502 P08406.090.0502 P08417.090.0502 P08428.090.0502	Potenza assorbita apparecchio / Luminaire power consumption 18W Flusso luminoso apparecchio / Luminaire luminous flux 1931lm 2700K Ra>90 220-240V AC dimmable (DALI/Push DIM) LED IP20	2,20
	Fornito completo di interruttore push, cavo 3m e spina Supplied complete with push switch, 3m cable and plug		
	P08405.090.0402 P08406.090.0402 P08417.090.0402 P08428.090.0402	Potenza assorbita apparecchio / Luminaire power consumption 18W Flusso luminoso apparecchio / Luminaire luminous flux 1931lm 3000K Ra>90 220-240V AC dimmable (DALI/Push DIM) LED IP20	2,20
	Fornito completo di interruttore push, cavo 3m e spina Supplied complete with push switch, 3m cable and plug		
	A08405.070.0502 A08406.070.0502 A08417.070.0502 A08428.070.0502	Potenza assorbita apparecchio / Luminaire power consumption 18W Flusso luminoso apparecchio / Luminaire luminous flux 1931lm 2700K Ra>90 220-240V AC dimmable (DALI/Push DIM) LED IP40	2,50
	Fornito completo di interruttore push, cavo 3m e spina Supplied complete with push switch, 3m cable and plug		
	A08405.070.0402 A08406.070.0402 A08417.070.0402 A08428.070.0402	Potenza assorbita apparecchio / Luminaire power consumption 18W Flusso luminoso apparecchio / Luminaire luminous flux 1931lm 3000K Ra>90 220-240V AC dimmable (DALI/Push DIM) LED IP40	2,50
	Fornito completo di interruttore push, cavo 3m e spina Supplied complete with push switch, 3m cable and plug		
	YKG08405.01 YKG08406.01 YKG08417.01 YKG08419.01 YKG08428.01	Kit griglia anti-abbagliamento per Dip (indoor) Anti-glare grid kit for Dip (indoor)	



FIREFLY IN THE SKY

Matteo Thun 2019

Registered Design



Firefly in the sky è un apparecchio a batteria da tavolo. La testa removibile racchiude sistema di aggancio magnetico, batteria ricaricabile tramite USB-C, sorgente LED e comando Step DIM a 5 regolazioni di intensità luminosa. In funzione delle condizioni di utilizzo per una ricarica di circa 4 ore si stima un'autonomia di circa 6 ore con intensità della luce al 100% e di circa 24 ore con intensità della luce al 25%. Base antiscivolo già in dotazione. Verde oliva materico, bianco soft materico, terracotta naturale materico e corten si aggiungono alle finiture disponibili nero satinato, bronzo e champagne.

Firefly in the sky is a battery table lamp. The removable head contains magnetic coupling system, rechargeable battery via USB-C, LED source and Step DIM control with 5 light intensity settings. Depending on the conditions of use for a recharge of approximately 4 hours, an autonomy of approximately 6 hours is estimated with 100% light intensity and approximately 24 hours with 25% light intensity. Anti-slip base included. Textured olive green, textured soft white, textured natural terracotta and corten are added to matte black, bronze and champagne finishes available.

CODICE CODE	FONTI LUMINOSE LIGHT SOURCES	kg
-------------	------------------------------	----

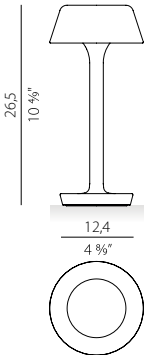

- C07805.011.0514**
- C07806.011.0514**
- C07816.011.0514**
- C07817.011.0514**
- C07827.011.0514**
- C07828.011.0514**
- C07829.011.0514**

Potenza assorbita apparecchio / Luminaire power consumption 2W
 Flusso luminoso apparecchio / Luminaire luminous flux 134lm
 2700K Ra>90 5V DC battery Dimmable (Step DIM)
IP65
 Interruttore incluso / Switch included

In funzione delle condizioni di utilizzo per una ricarica di circa 4 ore si stima un'autonomia di circa 6 ore con intensità della luce al 100% e di circa 24 ore con intensità della luce al 25%. Indicatore LED per lo stato di carica. La carica avviene tramite USB-C. Caricabatteria e cavetto inclusi.

Depending on the conditions of use for a recharge of approximately 4 hours, an autonomy of approximately 6 hours is estimated with 100% light intensity and approximately 24 hours with 25% light intensity. LED indicator for the load status. Charging takes place via USB-C. Battery charger and cable Included.

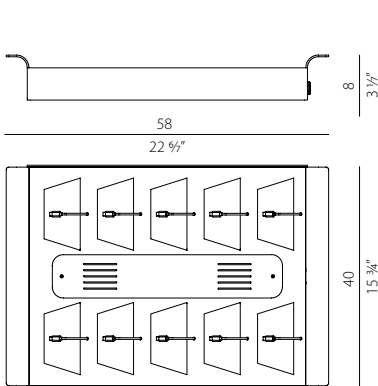

YRM07802.010	Vassoio per ricarica multipla di massimo 10 modelli Firefly in the Sky. Multiple charging tray for up to 10 Firefly in the Sky models.	4,03
--------------	--	------



Fotometrie disponibili www.panzeri.it / Photometric data available at www.panzeri.it

CODICI COLORI DISPONIBILI / COLOUR CODES AVAILABLE

- 05** champagne champagne
- 06** nero satinato matte black
- 16** corten corten
- 17** bronzo bronze
- 27** verde oliva materico textured olive green
- 28** bianco soft materico textured soft white
- 29** terracotta naturale materico textured natural terracotta



reddot winner 2020



Lampada a sospensione e a parete ad emissione diretta e indiretta. Sorgente luminosa LED, con driver ON-OFF con accensione separata o DALI/Push DIM. Finitura con vernice poliaccrilica in bianco o nero e finitura frontale del profilo liscia. Schermo in policarbonato estruso opale o microprismatico. Ideale per uffici, corridoi, scale.

Wall and suspension luminaire with direct and indirect light emission. Light source made of LED module with separate switching ON-OFF or DALI/Push DIM integrated drivers. Finish in polyacrylic paint in white or black and smooth front finish of the profile. Diffuser in opal or micro prismatic polycarbonate. Ideal for offices, corridors, stairways.

	CODICE CODE	FONTE LUMINOSA LIGHT SOURCES	kg
	L24647.150.0401 L24649.150.0401	Potenza assorbita apparecchio / Luminaire power consumption 56W Flusso luminoso apparecchio / Luminaire luminous flux 4541lm 3000K Ra>90 60° / 87° 220-240V AC ON-OFF IP40 Fornito con predisposizione per doppia accensione, n.2 diffusori opali e n.1 diffusore microprismatico Supplied with predisposition for double switch, n.2 opal diffusers and n.1 microprismatic diffuser	5,08
	L24647.150.0402 L24649.150.0402	Potenza assorbita apparecchio / Luminaire power consumption 54W Flusso luminoso apparecchio / Luminaire luminous flux 4541lm 3000K Ra>90 60° / 87° 220-240V AC dimmable (DALI/Push DIM) IP40 Fornito con n.2 diffusori opali e n.1 diffusore microprismatico Supplied with n. 2 opal diffusers and n.1 microprismatic diffuser	5,08
	L24647.200.0401 L24649.200.0401	Potenza assorbita apparecchio / Luminaire power consumption 72W Flusso luminoso apparecchio / Luminaire luminous flux 6055lm 3000K Ra>90 60° / 87° 220-240V AC ON-OFF IP40 Fornito con predisposizione per doppia accensione, n.2 diffusori opali e n.1 diffusore microprismatico Supplied with predisposition for double switch, n.2 opal diffusers and n.1 microprismatic diffuser	6,45
	L24647.200.0402 L24649.200.0402	Potenza assorbita apparecchio / Luminaire power consumption 70W Flusso luminoso apparecchio / Luminaire luminous flux 6055lm 3000K Ra>90 60° / 87° 220-240V AC dimmable (DALI/Push DIM) IP40 Fornito con n.2 diffusori opali e n.1 diffusore microprismatico Supplied with n.2 opal diffusers and n.1 microprismatic diffuser	6,45

	CODICE CODE	FONTI LUMINOSE LIGHT SOURCES	kg
	 A24646.025.0401 A24648.025.0401	Potenza assorbita apparecchio / Luminaire power consumption 11W Flusso luminoso apparecchio / Luminaire luminous flux 614lm 3000K Ra>90 220-240V AC ON-OFF IP40 Fornito con n.2 diffusori opali Supplied with n.2 opal diffusers	0,86
	 A24646.050.0401 A24648.050.0401	Potenza assorbita apparecchio / Luminaire power consumption 19W Flusso luminoso apparecchio / Luminaire luminous flux 1228lm 3000K Ra>90 220-240V AC ON-OFF IP40 Fornito con n.2 diffusori opali Supplied with n.2 opal diffusers	1,30
	 A24646.050.0402 A24648.050.0402	Potenza assorbita apparecchio / Luminaire power consumption 19W Flusso luminoso apparecchio / Luminaire luminous flux 1228lm 3000K Ra>90 220-240V AC dimmable (DALI/Push DIM) IP40 Fornito con n.2 diffusori opali Supplied with n.2 opal diffusers	1,32
	 A24646.100.0401 A24648.100.0401	Potenza assorbita apparecchio / Luminaire power consumption 38W Flusso luminoso apparecchio / Luminaire luminous flux 2456lm 3000K Ra>90 220-240V AC ON-OFF IP40 Doppia accensione. Fornito con n.2 diffusori opali Double switch. Supplied with n.2 opal diffusers	2,60
	 A24646.100.0402 A24648.100.0402	Potenza assorbita apparecchio / Luminaire power consumption 36W Flusso luminoso apparecchio / Luminaire luminous flux 2456lm 3000K Ra>90 220-240V AC dimmable (DALI/Push DIM) IP40 Fornito con n.2 diffusori opali Supplied with n.2 opal diffusers	2,64
	 A24646.150.0401 A24648.150.0401	Potenza assorbita apparecchio / Luminaire power consumption 56W Flusso luminoso apparecchio / Luminaire luminous flux 3683lm 3000K Ra>90 220-240V AC ON-OFF IP40 Fornito con predisposizione per doppia accensione, n.2 diffusori opali Supplied with predisposition for double switch, n. 2 opal diffusers	3,62
	 A24646.150.0402 A24648.150.0402	Potenza assorbita apparecchio / Luminaire power consumption 54W Flusso luminoso apparecchio / Luminaire luminous flux 3683lm 3000K Ra>90 220-240V AC dimmable (DALI/Push DIM) IP40 Fornito con n.2 diffusori opali Supplied with n.2 opal diffusers	3,92

Fotometrie disponibili www.panzeri.it / Photometric data available at www.panzeri.it UGR < 19 in funzione delle condizioni di installazione / UGR < 19 depending on installation conditions

CODICI COLORI DISPONIBILI / COLOUR CODES AVAILABLE

46 bianco/schermo opalino / white/opal screen **47** bianco/schermo prismato / white/prismatic screen **48** nero/schermo opalino / black/opal screen **49** nero/schermo prismato / black/prismatic screen

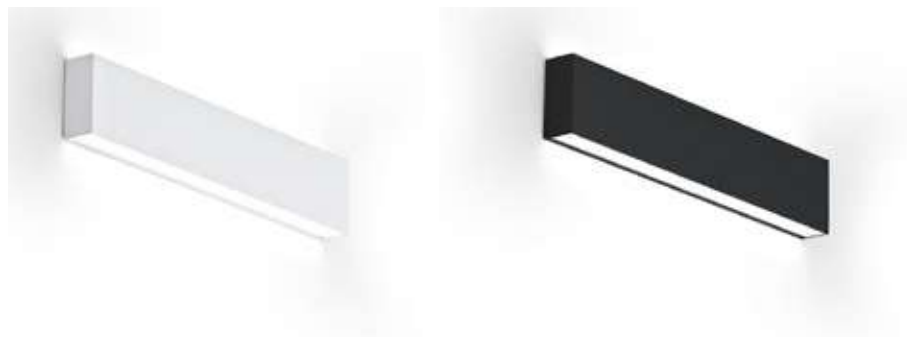



Lampada a sospensione, tavolo o soffitto costituita da vetro opale satinato soffiato e montatura in metallo rifinita con vernice poliaccrilica color bianco. Emissione di luce diffusa con possibilità di scelta di varie fonti luminose (LED, G9, E27). Omogenea diffusione della luce all'interno del vetro, senza zone in ombra. Ideale per un uso residenziale o per aree lobby in composizioni multiple.

Suspension, table and ceiling lamps in blown opal glass. Metal frame in white polyacrylic paint. Diffused light provided by different light sources (LED, G9, E27). Perfect and homogeneous distribution of the light, without any shadow. Ideal for residential use or for lobby areas in multiple compositions.

	CODICE CODE	FONTI LUMINOSE LIGHT SOURCES	kg
	L06501.022.0401	Potenza assorbita apparecchio / Luminaire power consumption 11W Flusso luminoso apparecchio / Luminaire luminous flux 929lm 3000K Ra>90 220-240V AC ON-OFF IP20	1,13
	L06501.022.0000	LED retrofit bulb G9 (L max 60mm - Ø max 17,5mm) max 60W G9 IP20	1,20
	L06501.037.0402	Potenza assorbita apparecchio / Luminaire power consumption 27W Flusso luminoso apparecchio / Luminaire luminous flux 2525lm 3000K Ra>90 220-240V AC dimmable (DALI/Push DIM) IP20	3,80
	L06501.037.0000	LED retrofit bulb E27 (L max 140mm - Ø max 65mm) max 150W E27 IP20	3,80
	L06501.045.0402	Potenza assorbita apparecchio / Luminaire power consumption 27W Flusso luminoso apparecchio / Luminaire luminous flux 2525lm 3000K Ra>90 220-240V AC dimmable (DALI/Push DIM) IP20	4,70
	L06501.045.0000	LED retrofit bulb E27 (L max 140mm - Ø max 65mm) max 150W E27 IP20	5,30
	P06501.037.0402	Potenza assorbita apparecchio / Luminaire power consumption 20W Flusso luminoso apparecchio / Luminaire luminous flux 1840lm 3000K Ra>90 220-240V AC dimmable (DALI/Push DIM) IP20	3,40
	P06501.037.0000	LED retrofit bulb E27 (L max 100mm - Ø max 55mm) max 150W E27 IP20	3,40
	P06501.045.0402	Potenza assorbita apparecchio / Luminaire power consumption 20W Flusso luminoso apparecchio / Luminaire luminous flux 1840lm 3000K Ra>90 220-240V AC dimmable (DALI/Push DIM) IP20	5,12
	P06501.045.0000	LED retrofit bulb E27 (L max 100mm - Ø max 55mm) max 150W E27 IP20	5,12
	C06501.022.0401	Potenza assorbita apparecchio / Luminaire power consumption 11W Flusso luminoso apparecchio / Luminaire luminous flux 692lm 3000K Ra>90 220-240V AC ON-OFF IP40	0,74

Fotometrie disponibili www.panzeri.it / Photometric data available at www.panzeri.it

CODICI COLORI DISPONIBILI / COLOUR CODES AVAILABLE

01 bianco
white











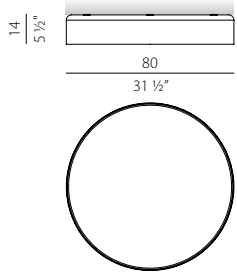

Lampada a sospensione e soffitto con diffusore microprismato a luminanza controllata. Versione a soffitto con emissione diretta attraverso modulo LED disponibile anche tunable white. La versione sospensione combina emissione diretta e indiretta dimmerabili. Corpo lampada in alluminio tornito rifinito con vernice poliaccrilica nelle versioni esterno nero e interno oro o esterno bianco e interno oro. Possibili colori custom su richiesta. Ideale per hall, zone living, grandi spazi, e uffici.

Suspension and ceiling lamp with microprismatic screen for controlled luminance. Ceiling version with direct light through LED modules also available tunable white. The suspension combines dimmable direct and indirect light. Lamp structure in turned aluminium finished in polyacrylic painted outside black and gold inside or outside white and gold inside. Custom colors are available on request. Ideal for halls, living areas, and public spaces and offices.

	CODICE CODE	FONTI LUMINOSE LIGHT SOURCES	kg
	L09280.050.0502 L09281.050.0502	Potenza assorbita apparecchio / Luminaire power consumption 36W Flusso luminoso apparecchio / Luminaire luminous flux 2916lm 2700K Ra>90 220-240V AC dimmable (DALI/Push DIM) IP20	6,27
	L09280.050.0402 L09281.050.0402	Potenza assorbita apparecchio / Luminaire power consumption 36W Flusso luminoso apparecchio / Luminaire luminous flux 2916lm 3000K Ra>90 220-240V AC dimmable (DALI/Push DIM) IP20	6,27
	L09280.080.0502 L09281.080.0502	Potenza assorbita apparecchio / Luminaire power consumption 82W Flusso luminoso apparecchio / Luminaire luminous flux 7782lm 2700K Ra>90 220-240V AC dimmable (DALI/Push DIM) IP20	10,97
	L09280.080.0402 L09281.080.0402	Potenza assorbita apparecchio / Luminaire power consumption 82W Flusso luminoso apparecchio / Luminaire luminous flux 7782lm 3000K Ra>90 220-240V AC dimmable (DALI/Push DIM) IP20	10,97
	P09280.030.0502 P09281.030.0502	Potenza assorbita apparecchio / Luminaire power consumption 15W Flusso luminoso apparecchio / Luminaire luminous flux 1397lm 2700K Ra>90 220-240V AC dimmable (DALI/Push DIM) IP20	5,22
	P09280.030.0402 P09281.030.0402	Potenza assorbita apparecchio / Luminaire power consumption 15W Flusso luminoso apparecchio / Luminaire luminous flux 1397lm 3000K Ra>90 220-240V AC dimmable (DALI/Push DIM) IP20	5,22
	P09280.050.0502 P09281.050.0502	Potenza assorbita apparecchio / Luminaire power consumption 25W Flusso luminoso apparecchio / Luminaire luminous flux 1877lm 2700K Ra>90 220-240V AC dimmable (DALI/Push DIM) IP20	5,22
	P09280.050.0402 P09281.050.0402	Potenza assorbita apparecchio / Luminaire power consumption 25W Flusso luminoso apparecchio / Luminaire luminous flux 1877lm 3000K Ra>90 220-240V AC dimmable (DALI/Push DIM) IP20	5,22
	P09280.050.9017 P09281.050.9017	Potenza assorbita apparecchio / Luminaire power consumption 30W Flusso lum. apparecchio / Luminaire luminous flux 1794lm min. / 2046lm max 2700-6500K Ra>90 220-240V AC tunable white IP20 Bianco dinamico, driver DALI DT8 / Switch dim / Color switch Tunable white, driver DALI DT8 / Switch dim / Color switch	5,22

GINEVRA

Christian Burtolf 2018

	CODICE CODE	FONTI LUMINOSE LIGHT SOURCES	kg
	 P09280.080.0502  P09281.080.0502	Potenza assorbita apparecchio / Luminaire power consumption 71W Flusso luminoso apparecchio / Luminaire luminous flux 6743lm 2700K Ra>90 220-240V AC dimmable (DALI/Push DIM)  IP20	10,07
	 P09280.080.0402  P09281.080.0402	Potenza assorbita apparecchio / Luminaire power consumption 71W Flusso luminoso apparecchio / Luminaire luminous flux 6743lm 3000K Ra>90 220-240V AC dimmable (DALI/Push DIM)  IP20	10,07
	 P09280.080.9017  P09281.080.9017	Potenza assorbita apparecchio / Luminaire power consumption 69W Flusso lum. apparecchio / Luminaire luminous flux 6518lm min. / 7190lm max 2700-6500K Ra>90 220-240V AC tunable white  IP20 Bianco dinamico, driver DALI DT8 / Switch dim / Color switch Tunable white, driver DALI DT8 / Switch dim / Color switch	10,07

Fotometrie disponibili www.panzeri.it / Photometric data available at www.panzeri.it UGR < 19 in funzione delle condizioni di installazione / UGR < 19 depending on installation conditions

CODICI COLORI DISPONIBILI / COLOUR CODES AVAILABLE

80 nero/oro
black/gold

81 bianco/oro
white/gold





Anello a sospensione in alluminio piegato con schermo superiore e inferiore in policarbonato opalino ad alta trasmittanza. Emissione di luce diretta e indiretta oppure solo diretta, tramite modulo LED. Dimmerazione DALI/ Push DIM di serie su tutte le versioni biemissione. Possibilità di avere LED 4000K su richiesta. Anello rifinito con vernice poliaccrilica color bianco, nero o decorata a mano con foglia oro. Possibilità di personalizzare i colori. Sospensione tramite 3 cavi in acciaio (6 nella versione ø 300cm). Spedizione del prodotto in un pezzo unico. La versione ø 300cm viene spedita in due semicerchi. Ideale per ambienti residenziali, grandi composizioni per uffici, strutture ricettive e spazi pubblici.

Suspension ring in curved aluminium with top and bottom high-transmittance screens in opal polycarbonate. Emission of both direct and indirect light or direct only, through LED modules. All double emission versions provided with DALI/Push DIM dimming. Possibility of having LED 4000K upon request. Ring eventually finished in polyacrylic white paint or black hand-decorated with golden leaf. Possibility to customize the colors. Suspended by means of 3 steel cables (6 in the ø 300cm version). Delivery of the product in a single piece. The ø 300cm version is shipped in two semicircles. Ideal for residential spaces, great compositions for offices, hospitality and public spaces.

GOLDEN RING

	CODICE CODE	FONTI LUMINOSE LIGHT SOURCES	kg
	L08101.080.0408 L08102.080.0408 L08121.080.0408	Potenza assorbita apparecchio / Luminaire power consumption 45W Flusso luminoso apparecchio / Luminaire luminous flux 3053lm 3000K Ra>90 220-240V AC ON-OFF IP40 850°	9,61
	L08101.080.0402 L08102.080.0402 L08121.080.0402	Potenza assorbita apparecchio / Luminaire power consumption 87W Flusso luminoso apparecchio / Luminaire luminous flux 6106lm 3000K Ra>90 220-240V AC dimmable (DALI/Push DIM) IP40 850°	10,68
	L08101.120.0402 L08102.120.0402 L08121.120.0402	Potenza assorbita apparecchio / Luminaire power consumption 150W Flusso luminoso apparecchio / Luminaire luminous flux 10466lm 3000K Ra>90 220-240V AC dimmable (DALI/Push DIM) IP40 850°	15,59
	L08101.180.0402 L08102.180.0402 L08121.180.0402	Potenza assorbita apparecchio / Luminaire power consumption 220W Flusso luminoso apparecchio / Luminaire luminous flux 15699lm 3000K Ra>90 220-240V AC dimmable (DALI/Push DIM) IP40 850°	23,05
	M8101-3 M8102-3 M8121-3	Rosone per collegamento elettrico e per raggruppamento di 3 funi in acciaio. Canopy for power supply and to join 3 steel cables.	0,58

RING COLLECTION

Enzo Panzeri 2015

Registered Design

	CODICE CODE	FONTI LUMINOSE LIGHT SOURCES	kg
	L08101.300.0402	Potenza assorbita apparecchio / Luminaire power consumption 370W	41,48
	L08102.300.0402	Flusso luminoso apparecchio / Luminaire luminous flux 26166lm	
	L08121.300.0402	3000K Ra>90 220-240V AC dimmable (DALI/Push DIM)	
		LED IP40 850°	
		Apparecchio fornito in 2 parti da montare Fixture in 2 parts to compose	

	M8101-6	Rosone per collegamento elettrico e per raggruppamento di 6 funi in acciaio. 2,91
	M8102-6	Canopy for power supply and to join 6 steel cables.
	M8121-6	



Fotometrie disponibili www.panzeri.it / Photometric data available at www.panzeri.it

CODICI COLORI DISPONIBILI / COLOUR CODES AVAILABLE

Disponibili a richiesta LED 2700K o 4000K / On request 2700K or 4000K LED available

01 bianco
white

02 nero
black

21 foglia oro
gold leaf





Anello in alluminio con schermo inferiore in polycarbonato opale ad alta trasmittanza. Disponibile nelle versioni parete/soffitto e sospensione. Emissione di luce diretta attraverso modulo LED con dimmerazione DALI/Push DIM di serie su tutte le versioni. Anello rifinito con vernice poliaccrilica color bianco, nero, bronzo o decorato a mano con foglia oro. Possibili colori custom su richiesta. Versione a sospensione fornita con 3 cavi in acciaio regolabili in lunghezza (6 cavi per \varnothing 180cm). Versioni a parete/soffitto fornite di kit di montaggio semplificato. Ideale per ambienti residenziali, grandi composizioni per uffici, strutture ricettive e spazi pubblici. Spedizione del prodotto in un pezzo unico già assemblato.

Aluminium ring with bottom high-transmittance screen in opal polycarbonate. Available in wall/ceiling and suspension versions. Emission of direct light provided by LED module with technology DALI/Push DIM on all versions. Ring eventually finished in polyacrilic paint white, black, bronze or hand-decorated in golden leaf. Custom colors are available on request. Suspended version supplied with 3 steel cable adjustable in length (6 cables for \varnothing 180cm). The wall/ceiling version is supplied with a simplified mounting kit. Ideal for residential use, compositions for offices, hospitality facilities and public spaces. Delivery of the product in single piece already assembled.

SILVER RING

	CODICE CODE	FONTI LUMINOSE LIGHT SOURCES	kg
	L08201.050.0402 L08202.050.0402 L08217.050.0402 L08221.050.0402	Potenza assorbita apparecchio / Luminaire power consumption 25W Flusso luminoso apparecchio / Luminaire luminous flux 1809lm 3000K Ra>90 220-240V AC dimmable (DALI/Push DIM) IP40 85°	4,81
	L08201.080.0402 L08202.080.0402 L08217.080.0402 L08221.080.0402	Potenza assorbita apparecchio / Luminaire power consumption 45W Flusso luminoso apparecchio / Luminaire luminous flux 3053lm 3000K Ra>90 220-240V AC dimmable (DALI/Push DIM) IP40 85°	8,74
	L08201.120.0402 L08202.120.0402 L08217.120.0402 L08221.120.0402	Potenza assorbita apparecchio / Luminaire power consumption 75W Flusso luminoso apparecchio / Luminaire luminous flux 5233lm 3000K Ra>90 220-240V AC dimmable (DALI/Push DIM) IP40 85°	13,42
	L08201.180.0402 L08202.180.0402 L08217.180.0402 L08221.180.0402	Potenza assorbita apparecchio / Luminaire power consumption 110W Flusso luminoso apparecchio / Luminaire luminous flux 7850lm 3000K Ra>90 220-240V AC dimmable (DALI/Push DIM) IP40 85°	21,31

RING COLLECTION

Enzo Panzeri 2016

		CODICE CODE	FONTI LUMINOSE LIGHT SOURCES	kg
		P08201.050.0402	Potenza assorbita apparecchio / Luminaire power consumption 25W	4,90
		P08202.050.0402	Flusso luminoso apparecchio / Luminaire luminous flux 1809lm	
		P08217.050.0402	3000K Ra>90 220-240V AC dimmable (DALI/Push DIM)	
		P08221.050.0402	IP40 850°	
		P08201.080.0402	Potenza assorbita apparecchio / Luminaire power consumption 45W	7,63
		P08202.080.0402	Flusso luminoso apparecchio / Luminaire luminous flux 3053lm	
		P08217.080.0402	3000K Ra>90 220-240V AC dimmable (DALI/Push DIM)	
		P08221.080.0402	IP40 850°	
		P08201.120.0402	Potenza assorbita apparecchio / Luminaire power consumption 75W	11,63
		P08202.120.0402	Flusso luminoso apparecchio / Luminaire luminous flux 5233lm	
		P08217.120.0402	3000K Ra>90 220-240V AC dimmable (DALI/Push DIM)	
		P08221.120.0402	IP40 850°	
		P08201.180.0402	Potenza assorbita apparecchio / Luminaire power consumption 110W	18,86
		P08202.180.0402	Flusso luminoso apparecchio / Luminaire luminous flux 7850lm	
		P08217.180.0402	3000K Ra>90 220-240V AC dimmable (DALI/Push DIM)	
		P08221.180.0402	IP40 850°	



Fotometrie disponibili www.panzeri.it / Photometric data available at www.panzeri.it

CODICI COLORI DISPONIBILI / COLOUR CODES AVAILABLE

Disponibili a richiesta LED 2700K o 4000K / On request 2700K or 4000K LED available

01 bianco white **02** nero black **17** bronzo bronze **21** foglia oro gold leaf





Lampada a sospensione in alluminio tornito. Emissione indiretta attraverso COB LED con dimmerazione DALI/ Push DIM integrata. Disco rifinito con vernice poliaccrilica color bianco, nero e decorata a mano con foglia oro. Possibili colori custom su richiesta. Ideale per hall, zone living, grandi spazi.

Suspension lamp in turned aluminium. Emission of indirect light provided by LED COB with integrated technology DALI/Push DIM. Fixture finished in polyacrylic paint white, black and hand-decorated in golden leaf. Custom colors are available on request. Ideal for halls, living, and public spaces.

CODICE CODE	FONTI LUMINOSE LIGHT SOURCES	kg
-------------	------------------------------	----



L09301.060.0402
L09302.060.0402
L09321.060.0402

Potenza assorbita apparecchio / Luminaire power consumption 43W
 Flusso luminoso apparecchio / Luminaire luminous flux 4413lm
 3000K Ra>90 220-240V AC dimmable (DALI/Push DIM)

3,46

IP20

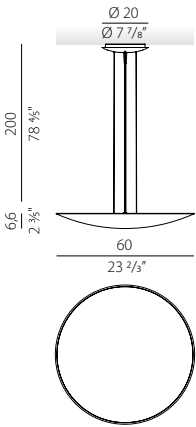

L09301.100.0402
L09302.100.0402
L09321.100.0402

Potenza assorbita apparecchio / Luminaire power consumption 88W
 Flusso luminoso apparecchio / Luminaire luminous flux 8825lm
 3000K Ra>90 220-240V AC dimmable (DALI/Push DIM)

7,35

IP20

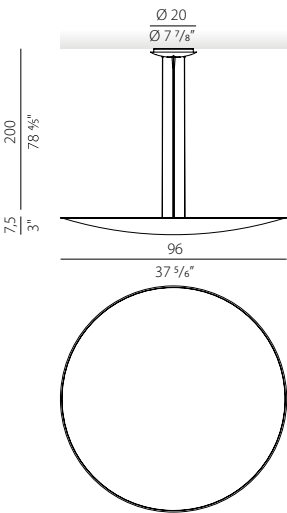

Fotometrie disponibili www.panzeri.it / Photometric data available at www.panzeri.it

CODICI COLORI DISPONIBILI / COLOUR CODES AVAILABLE

01 bianco
white

02 nero
black

21 foglia oro
gold leaf





La gamma di lampade da parete della serie GONIO risponde ai più elevati standard di comfort visivo per l'illuminazione di ambienti di passaggio o di accoglienza quali corridoi, anticamere, hall di alberghi e uffici. Geometrie calibrate ne fanno un prodotto dalle forme essenziali ottimizzate per una perfetta distribuzione dei fasci luminosi verso l'alto e verso il basso, ottenuta grazie all'uso di lenti professionali con angolazioni studiate per evitare qualsiasi tipo di abbagliamento. Il corpo è realizzato in alluminio estruso con terminali di chiusura in pressofusione di alluminio, disponibile nelle finiture bianco, nero, bronzo, ottone satinato e titanio. È proposto in tre versioni di lunghezze differenti per maggiori possibilità applicative, completo di driver dimmerabile integrato per regolazione dell'intensità luminosa tramite dispositivi DALI o Push DIM.

GONIO is a range of wall mount sconces that respond to the most elevated standards of visual comfort for the illumination of pathways or hospitality areas, such as corridors, waiting rooms, halls and offices. Precise geometries and essential lines make GONIO a product optimized for a better distribution of light upwards and downwards, thanks to the use of professional lenses with angle degrees engineered to avoid any kind of glaring. The body of the lamp is built in extruded aluminum with end caps in aluminum die-cast, available in white, black, bronze, matte brass and titanium finishes. It is offered in three versions with different lengths for greater application settings, complete with integrated dimmable driver for regulating the light intensity through DALI or Push DIM devices.

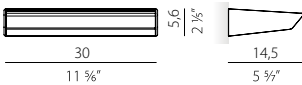

CODICE CODE	FONTI LUMINOSE LIGHT SOURCES	kg
A01901.030.0502	Potenza assorbita apparecchio / Luminaire power consumption 24W	1,08
A01902.030.0502	Flusso luminoso apparecchio / Luminaire luminous flux 2168lm	
A01917.030.0502	2700K Ra>90 220-240V AC dimmable (DALI/Push DIM)	
A01919.030.0502	IP40	
A01930.030.0502		
A01901.030.0402	Potenza assorbita apparecchio / Luminaire power consumption 24W	1,08
A01902.030.0402	Flusso luminoso apparecchio / Luminaire luminous flux 2252lm	
A01917.030.0402	3000K Ra>90 220-240V AC dimmable (DALI/Push DIM)	
A01919.030.0402	IP40	
A01930.030.0402		



A01901.045.0502	Potenza assorbita apparecchio / Luminaire power consumption 35W	1,37
A01902.045.0502	Flusso luminoso apparecchio / Luminaire luminous flux 3252lm	
A01917.045.0502	2700K Ra>90 220-240V AC dimmable (DALI/Push DIM)	
A01919.045.0502	IP40	
A01930.045.0502		
A01901.045.0402	Potenza assorbita apparecchio / Luminaire power consumption 35W	1,37
A01902.045.0402	Flusso luminoso apparecchio / Luminaire luminous flux 3378lm	
A01917.045.0402	3000K Ra>90 220-240V AC dimmable (DALI/Push DIM)	
A01919.045.0402	IP40	
A01930.045.0402		

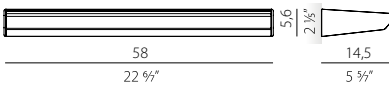

A01901.060.0502	Potenza assorbita apparecchio / Luminaire power consumption 45W	2,05
A01902.060.0502	Flusso luminoso apparecchio / Luminaire luminous flux 4337lm	
A01917.060.0502	2700K Ra>90 220-240V AC dimmable (DALI/Push DIM)	
A01919.060.0502	IP40	
A01930.060.0502		
A01901.060.0402	Potenza assorbita apparecchio / Luminaire power consumption 45W	2,05
A01902.060.0402	Flusso luminoso apparecchio / Luminaire luminous flux 4503lm	
A01917.060.0402	3000K Ra>90 220-240V AC dimmable (DALI/Push DIM)	
A01919.060.0402	IP40	
A01930.060.0402		

Fotometrie disponibili www.panzeri.it / Photometric data available at www.panzeri.it

Disponibili a richiesta con lente 100° / 100° lens version available on request

CODICI COLORI DISPONIBILI / COLOUR CODES AVAILABLE

- 01** bianco
white
- 02** nero
black
- 17** bronzo
bronzes
- 19** ottone satinato
matte brass
- 30** titanio
titanium



SCHEMA DI DISTRIBUZIONE DELLA LUCE / LIGHT DISTRIBUTION SCHEME

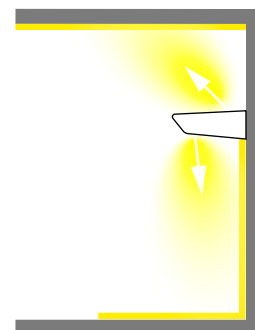

Emissione asimmetrica
Asymmetric emission



Un corpo illuminante costituito dalla combinazione di elementi lineari trasversali e longitudinali, in grado di caratterizzare con le sue infinite possibilità compositive la scenografia di ogni ambiente. Le numerose varianti consentono un'installazione libera e intuitiva sia a sospensione che a soffitto o parete. La doppia emissione costituisce un ulteriore fattore di versatilità: nella versione a sospensione infatti è possibile invertire l'orientamento delle funi, permettendo l'installazione del prodotto su entrambe le facce per una maggiore illuminazione diretta o indiretta. I modelli a sospensione sono inoltre abbinabili agli articoli To-Be 22, per uno sviluppo tridimensionale delle composizioni. Disponibile nelle finiture bianco, nero satinato, bronzo, ottone satinato e titanio, con diffusori opalini o neri.

A lighting fitting made of a combination of linear longitudinal elements, enabling to characterize every interior space with its endless configuration possibilities. The many variants allow a free and intuitive installation, suspended or surface mounted on ceiling or wall. The double emission provides an additional versatility factor: the suspended version allows to invert the hanging steel cables, enabling the installation of the product on both sides for an illumination with majority of light downwards or upwards. Furthermore, the suspension models can be combined with To-Be 22, for a tridimensional construction of the product layout. Available in finishes white, satin black, bronze, matte brass, titanium, with white opal diffuser or black diffuser.

CODICE CODE	FONTI LUMINOSE LIGHT SOURCES	kg
L02801.115.0502	Potenza assorbita apparecchio / Luminaire power consumption 80W	2,80
L02806.115.0502	Flusso luminoso apparecchio / Luminaire luminous flux 5045lm	
L02805.115.0502	2700K Ra>90 220-240V AC dimmable (DALI/Push DIM)	
L02817.115.0502	IP20	
L02819.115.0502	Diffusori opali / Opal diffusers	
L02830.115.0502		
L02801.115.0402	Potenza assorbita apparecchio / Luminaire power consumption 80W	2,80
L02806.115.0402	Flusso luminoso apparecchio / Luminaire luminous flux 5045lm	
L02805.115.0402	3000K Ra>90 220-240V AC dimmable (DALI/Push DIM)	
L02817.115.0402	IP20	
L02819.115.0402	Diffusori opali / Opal diffusers	
L02830.115.0402		
L02901.115.0502	Potenza assorbita apparecchio / Luminaire power consumption 80W	2,80
L02906.115.0502	Flusso luminoso apparecchio / Luminaire luminous flux 2118lm	
L02905.115.0502	2700K Ra>90 220-240V AC dimmable (DALI/Push DIM)	
L02917.115.0502	IP20	
L02919.115.0502	Diffusori neri / Black diffusers	
L02930.115.0502		
L02901.115.0402	Potenza assorbita apparecchio / Luminaire power consumption 80W	2,80
L02906.115.0402	Flusso luminoso apparecchio / Luminaire luminous flux 2118lm	
L02905.115.0402	3000K Ra>90 220-240V AC dimmable (DALI/Push DIM)	
L02917.115.0402	IP20	
L02919.115.0402	Diffusori neri / Black diffusers	
L02930.115.0402		

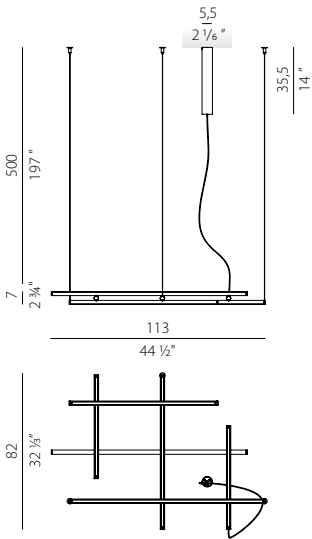

ORIENTAMENTI D'INSTALLAZIONE / INSTALLATION LAYOUTS

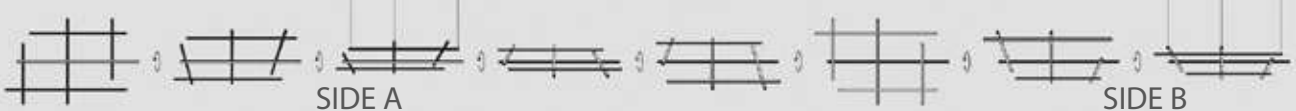



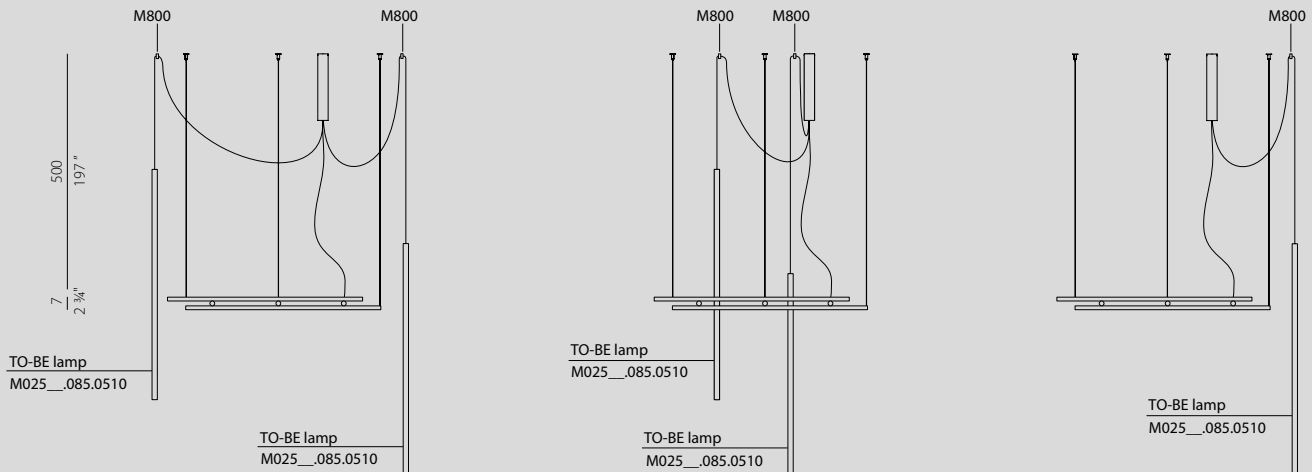



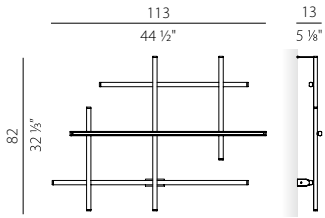





ESEMPI D'INSTALLAZIONE / INSTALLATION EXAMPLES



	CODICE CODE	FONTI LUMINOSE LIGHT SOURCES	kg
	P02801.115.0502	Potenza assorbita apparecchio / Luminaire power consumption 78W	2,97
	P02806.115.0502	Flusso luminoso apparecchio / Luminaire luminous flux 4602lm	
	P02805.115.0502	2700K Ra>90 220-240V AC dimmable (DALI/Push DIM)	
	P02817.115.0502	IP20	
	P02819.115.0502	Diffusori opali	
	P02830.115.0502	Opal diffusers	
	P02801.115.0402	Potenza assorbita apparecchio / Luminaire power consumption 78W	2,97
	P02806.115.0402	Flusso luminoso apparecchio / Luminaire luminous flux 4602lm	
	P02805.115.0402	3000K Ra>90 220-240V AC dimmable (DALI/Push DIM)	
	P02817.115.0402	IP20	
	P02819.115.0402	Diffusori opali	
	P02830.115.0402	Opal diffusers	
	P02901.115.0502	Potenza assorbita apparecchio / Luminaire power consumption 78W	2,97
	P02906.115.0502	Flusso luminoso apparecchio / Luminaire luminous flux 2356lm	
	P02905.115.0502	2700K Ra>90 220-240V AC dimmable (DALI/Push DIM)	
	P02917.115.0502	IP20	
	P02919.115.0502	Diffusori neri	
	P02930.115.0502	Black diffusers	
	P02901.115.0402	Potenza assorbita apparecchio / Luminaire power consumption 78W	2,97
	P02906.115.0402	Flusso luminoso apparecchio / Luminaire luminous flux 2356lm	
	P02905.115.0402	3000K Ra>90 220-240V AC dimmable (DALI/Push DIM)	
	P02917.115.0402	IP20	
	P02919.115.0402	Diffusori neri	
	P02930.115.0402	Black diffusers	
	P02801.115.0510	Potenza assorbita apparecchio / Luminaire power consumption 72W	2,15
	P02806.115.0510	Flusso luminoso apparecchio / Luminaire luminous flux 4897lm	
	P02805.115.0510	2700K Ra>90 24V DC	
	P02817.115.0510	IP20	
	P02819.115.0510	Diffusori opali, driver non incluso	
	P02830.115.0510	Opal diffusers, driver not included	
	P02801.115.0410	Potenza assorbita apparecchio / Luminaire power consumption 72W	2,15
	P02806.115.0410	Flusso luminoso apparecchio / Luminaire luminous flux 4897lm	
	P02805.115.0410	3000K Ra>90 24V DC	
	P02817.115.0410	IP20	
	P02819.115.0410	Diffusori opali, driver non incluso	
	P02830.115.0410	Opal diffusers, driver not included	
	P02901.115.0510	Potenza assorbita apparecchio / Luminaire power consumption 72W	2,15
	P02906.115.0510	Flusso luminoso apparecchio / Luminaire luminous flux 2651lm	
	P02905.115.0510	2700K Ra>90 24V DC	
	P02917.115.0510	IP20	
	P02919.115.0510	Diffusori neri, driver non incluso	
	P02930.115.0510	Black diffusers, driver not included	
	P02901.115.0410	Potenza assorbita apparecchio / Luminaire power consumption 72W	2,15
	P02906.115.0410	Flusso luminoso apparecchio / Luminaire luminous flux 2651lm	
	P02905.115.0410	3000K Ra>90 24V DC	
	P02917.115.0410	IP20	
	P02919.115.0410	Diffusori neri, driver non incluso	
	P02930.115.0410	Black diffusers, driver not included	



CODICE CODE	FONTI LUMINOSE LIGHT SOURCES	kg
 A02901.115.0502	Potenza assorbita apparecchio / Luminaire power consumption 77W	2,97
 A02906.115.0502	Flusso luminoso apparecchio / Luminaire luminous flux 3812lm	
A02905.115.0502	2700K Ra>90 220-240V AC dimmable (DALI/Push DIM)	
 A02917.115.0502	IP20	
A02919.115.0502	Diffusore frontale nero	
A02930.115.0502	Black front diffuser	
 A02901.115.0402	Potenza assorbita apparecchio / Luminaire power consumption 77W	2,97
 A02906.115.0402	Flusso luminoso apparecchio / Luminaire luminous flux 3812lm	
A02905.115.0402	3000K Ra>90 220-240V AC dimmable (DALI/Push DIM)	
 A02917.115.0402	IP20	
A02919.115.0402	Diffusore frontale nero	
A02930.115.0402	Black front diffuser	
 A02901.115.0510	Potenza assorbita apparecchio / Luminaire power consumption 71W	2,15
 A02906.115.0510	Flusso luminoso apparecchio / Luminaire luminous flux 4088lm	
A02905.115.0510	2700K Ra>90 24V DC	
 A02917.115.0510	IP20 ⚡	
A02919.115.0510	Diffusore frontale nero, driver non incluso	
A02930.115.0510	Black front diffuser, driver not included	
 A02901.115.0410	Potenza assorbita apparecchio / Luminaire power consumption 71W	2,15
 A02906.115.0410	Flusso luminoso apparecchio / Luminaire luminous flux 4088lm	
A02905.115.0410	3000K Ra>90 24V DC	
 A02917.115.0410	IP20 ⚡	
A02919.115.0410	Diffusore frontale nero, driver non incluso	
A02930.115.0410	Black front diffuser, driver not included	

Fotometrie disponibili www.panzeri.it / Photometric data available at www.panzeri.it

VERFÜGBARE FARBCODES / CODES DISPONIBLES

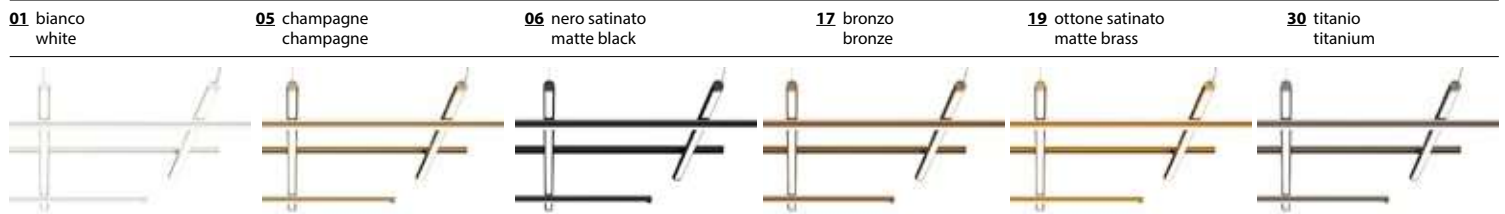



HILOW LINE

Matteo Thun e Benedetto Fasciana 2021



Dall'esperienza di Hilow nasce la serie che rappresenta il principio fondante del sistema nella sua forma più elementare: un modulo lineare sottile e discreto anche nell'emissione di luce; un'asta luminosa applicabile a muro o per installazione libera a pavimento, con struttura in alluminio estruso e schermo rivolto verso la parete per un gradevole effetto di luce indiretta e soffusa. L'intensità di luce può essere ridotta sia nei modelli da parete, grazie al driver integrato regolabile tramite tecnologia DALI o Push DIM, che nelle piantane, dotate di cavo con pedale di regolazione. Versioni a parete disponibili nelle finiture bianco, nero satinato, champagne, bronzo, ottone satinato e titanio. Versione terra con basamento in travertino, marmo nero marquina, verde alpi, rosso Lepanto o emperador dark.

From the success of Hilow, this new series represents the founding principle of the system in its purest form: a linear module slender and discreet also in the light emission; a luminous stick to install on the wall or free-standing on the floor, with a structure in extruded aluminum and diffuser directed towards the wall for a comfortable indirect light effect. The intensity of light can be dimmed both in the wall mount version, thanks to the integrated driver through DALI or Push DIM technology, and in the floor version, equipped with electrical cable with dimming pedal. Wall-mount versions are available in white, matte black, champagne, bronze, matte brass and titanium finishes. Floor versions with base in travertine, marquina black, verde alpi, Lepanto red or emperador dark.

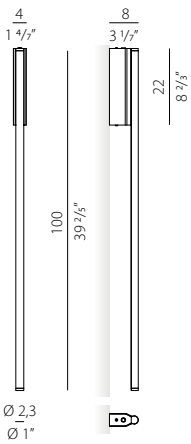

CODICE CODE	FONTI LUMINOSE LIGHT SOURCES	kg
A11001.100.0502	Potenza assorbita apparecchio / Luminaire power consumption 17W	1,16
A11006.100.0502	Flusso luminoso apparecchio / Luminaire luminous flux 1018lm	
A11005.100.0502	2700K Ra>90 220-240V AC dimmable (DALI/Push DIM)	
A11017.100.0502	IP20	
A11019.100.0502		
A11030.100.0502		
A11001.100.0502	Potenza assorbita apparecchio / Luminaire power consumption 17W	1,16
A11006.100.0502	Flusso luminoso apparecchio / Luminaire luminous flux 1018lm	
A11005.100.0502	3000K Ra>90 220-240V AC dimmable (DALI/Push DIM)	
A11017.100.0502	IP20	
A11019.100.0502		
A11030.100.0502		

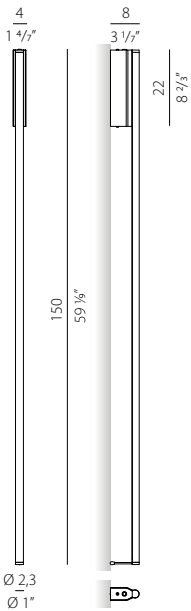



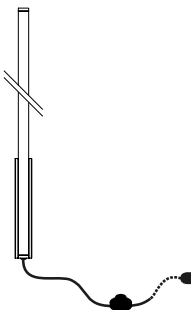



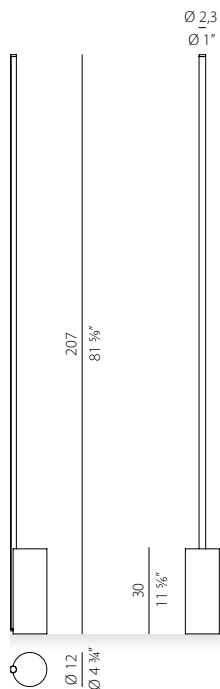























A11001.150.0502	Potenza assorbita apparecchio / Luminaire power consumption 27W	1,35
A11006.150.0502	Flusso luminoso apparecchio / Luminaire luminous flux 1696lm	
A11005.150.0502	2700K Ra>90 220-240V AC dimmable (DALI/Push DIM)	
A11017.150.0502	IP20	
A11019.150.0502		
A11030.150.0502		
A11001.150.0502	Potenza assorbita apparecchio / Luminaire power consumption 27W	1,35
A11006.150.0502	Flusso luminoso apparecchio / Luminaire luminous flux 1696lm	
A11005.150.0502	3000K Ra>90 220-240V AC dimmable (DALI/Push DIM)	
A11017.150.0502	IP20	
A11019.150.0502		
A11030.150.0502		



YC11002_400	Cavo di alimentazione di lunghezza 4m (157,5") con interruttore a pedale e spina. 4m (157,5") long power cable with foot switch and plug. Accessorio per Hilow Line A110 Accessory for Hilow Line A110	0,26
--------------------	---	------



	CODICE CODE	FONTI LUMINOSE LIGHT SOURCES	kg
	T10705.200.0522	Potenza assorbita apparecchio / Luminaire power consumption 39W	10,01
	T10706.200.0522	Flusso luminoso apparecchio / Luminaire luminous flux 2714lm	
	T10717.200.0522	2700K Ra>90 220-240V AC dimmer on cable	
	T10719.200.0522	 IP20 	
	T10705.200.0422	Potenza assorbita apparecchio / Luminaire power consumption 39W	10,01
	T10706.200.0422	Flusso luminoso apparecchio / Luminaire luminous flux 2714lm	
	T10717.200.0422	3000K Ra>90 220-240V AC dimmer on cable	
	T10719.200.0422	 IP20  Base di appoggio in marmo verde alpi Bearing base in "verde alpi" marble	
	T10805.200.0522	Potenza assorbita apparecchio / Luminaire power consumption 39W	9,44
	T10817.200.0522	Flusso luminoso apparecchio / Luminaire luminous flux 2714lm	
	T10819.200.0522	2700K Ra>90 220-240V AC dimmer on cable	
	T10828.200.0522	 IP20 	
	T10805.200.0422	Potenza assorbita apparecchio / Luminaire power consumption 39W	9,44
	T10817.200.0422	Flusso luminoso apparecchio / Luminaire luminous flux 2714lm	
	T10819.200.0422	3000K Ra>90 220-240V AC dimmer on cable	
	T10828.200.0422	 IP20  Base di appoggio in travertino Bearing base in travertine	
	T10905.200.0522	Potenza assorbita apparecchio / Luminaire power consumption 39W	10,01
	T10906.200.0522	Flusso luminoso apparecchio / Luminaire luminous flux 2714lm	
	T10917.200.0522	2700K Ra>90 220-240V AC dimmer on cable	
	T10919.200.0522	 IP20 	
	T10905.200.0422	Potenza assorbita apparecchio / Luminaire power consumption 39W	10,01
	T10906.200.0422	Flusso luminoso apparecchio / Luminaire luminous flux 2714lm	
	T10917.200.0422	3000K Ra>90 220-240V AC dimmer on cable	
	T10919.200.0422	 IP20  Base di appoggio in marmo nero marquina Bearing base in black marquina marble	
	T10405.200.0522	Potenza assorbita apparecchio / Luminaire power consumption 39W	10,01
	T10417.200.0522	Flusso luminoso apparecchio / Luminaire luminous flux 2714lm	
	T10419.200.0522	2700K Ra>90 220-240V AC dimmer on cable  IP20 	
	T10405.200.0422	Potenza assorbita apparecchio / Luminaire power consumption 39W	10,01
	T10417.200.0422	Flusso luminoso apparecchio / Luminaire luminous flux 2714lm	
	T10419.200.0422	3000K Ra>90 220-240V AC dimmer on cable  IP20  Base di appoggio in marmo rosso Lepanto Bearing base in Lepanto red marble	
	T10505.200.0522	otenza assorbita apparecchio / Luminaire power consumption 39W	10,01
	T10517.200.0522	Flusso luminoso apparecchio / Luminaire luminous flux 2714lm	
	T10519.200.0522	2700K Ra>90 220-240V AC dimmer on cable  IP20 	
	T10505.200.0422	otenza assorbita apparecchio / Luminaire power consumption 39W	10,01
	T10517.200.0422	Flusso luminoso apparecchio / Luminaire luminous flux 2714lm	
	T10519.200.0422	3000K Ra>90 220-240V AC dimmer on cable  IP20  Base di appoggio in marmo Emperador dark Bearing base in Emperador dark marble	

Fotometrie disponibili www.panzeri.it / Photometric data available at www.panzeri.it

CODICI COLORI DISPONIBILI / COLOUR CODES AVAILABLE

01 bianco white
05 champagne champagne
06 nero satinato matte black
17 bronzo bronze
19 ottone satinato matte brass
28 bianco soft materico textured soft white
30 titanio titanium
02 nero black



Lampada da tavolo, terra o parete/soffitto costituita da estruso in alluminio per la struttura e pressofusione di alluminio per la testa e lo snodo. Diffusore in policarbonato con perimetro luminoso e doppia serigrafia appositamente studiata per ottimizzare il fascio luminoso e ridurre l'abbagliamento. Fascio luminoso orientabile e dimmerabile per tutte le versioni (tranne versione P) con tecnologia Step DIM a 5 regolazioni di intensità luminosa e luce di cortesia. Struttura rifinita con vernice poliacrilica in bianco, nero, ottone satinato o spazzolato e verniciato colore titanio. Testa rotante su 2 assi grazie a un doppio snodo, disponibile con sensore di presenza. Miniaturizzazione del giunto a snodo con possibilità di regolarne la tenuta. Disponibili accessori nella versione C: morsetto, perno e braccio parete. Ideale per uffici, scrivanie, studi, zone notte.

Table, floor or wall/ceiling lamp made of extruded aluminium for the structure and die-cast aluminium for the head and the junction. Diffuser in polycarbonate with luminous perimeter and double screen serigraphy, specifically designed to optimize the beam and reduce the glare. Swiveling light beam and dimmable for all versions (except for version P) with technology Step DIM with 5 intensity of light settings and courtesy light. Structure in white, black or matte brass polyacrylic paint, or brushed and colored titanium. Rotating head on 2-axis through a double joint. Miniaturization of the junction with the possibility of regulating the tightness, presence detector available. Accessories available in the C version: clamp, pin and the wall arm. Ideal for offices, desks, studios, night zones.

	CODICE CODE	FONTI LUMINOSE LIGHT SOURCES	kg
	C07701.000.0409 C07702.000.0409 C07719.000.0409 C07730.000.0409	Potenza assorbita apparecchio / Luminaire power consumption 10W Flusso luminoso apparecchio / Luminaire luminous flux 706lm 3000K Ra>90 90° 220-240V AC dimmable (Step DIM) LED IP40	4,10
	C07701.000.0409P C07702.000.0409P C07719.000.0409P C07730.000.0409P	Potenza assorbita apparecchio / Luminaire power consumption 10W Flusso luminoso apparecchio / Luminaire luminous flux 706lm 3000K Ra>90 90° 220-240V AC dimmable (Step DIM) LED IP40	4,10
	Versione con sensore di presenza Presence detector version		
	CM07701.000.0409 CM07702.000.0409 CM07730.000.0409	Potenza assorbita apparecchio / Luminaire power consumption 10W Flusso luminoso apparecchio / Luminaire luminous flux 706lm 3000K Ra>90 90° 220-240V AC dimmable (Step DIM) LED IP40	0,83
	CP07701.000.0409 CP07702.000.0409 CP07730.000.0409	Potenza assorbita apparecchio / Luminaire power consumption 10W Flusso luminoso apparecchio / Luminaire luminous flux 706lm 3000K Ra>90 90° 220-240V AC dimmable (Step DIM) LED IP40	0,63
	CA07701.000.0409 CA07702.000.0409 CA07730.000.0409	Potenza assorbita apparecchio / Luminaire power consumption 10W Flusso luminoso apparecchio / Luminaire luminous flux 706lm 3000K Ra>90 90° 220-240V AC dimmable (Step DIM) LED IP40	0,84

JACKIE

Enzo Panzeri 2015

Registered Design

	CODICE CODE	FONTI LUMINOSE LIGHT SOURCES	kg
	T07701.000.0409	Potenza assorbita apparecchio / Luminaire power consumption 10W	5,21
	T07702.000.0409	Flusso luminoso apparecchio / Luminaire luminous flux 706lm	
	T07730.000.0409	3000K Ra>90 90° 220-240V AC dimmable (Step DIM)	
		IP40	
	A07701.000.0409	Potenza assorbita apparecchio / Luminaire power consumption 10W	0,47
	A07702.000.0409	Flusso luminoso apparecchio / Luminaire luminous flux 706lm	
	A07730.000.0409	3000K Ra>90 90° 220-240V AC dimmable (Step DIM)	
		IP40	
	P07701.000.0101	Potenza assorbita apparecchio / Luminaire power consumption 8,5W	0,46
	P07702.000.0101	Flusso luminoso apparecchio / Luminaire luminous flux 820lm	
	P07730.000.0101	3000K Ra>80 90° 220-240V AC ON-OFF	
		IP40	



Fotometrie disponibili www.panzeri.it / Photometric data available at www.panzeri.it

CODICI COLORI DISPONIBILI / COLOUR CODES AVAILABLE

01 bianco
white

02 nero
black

19 ottone satinato
matte brass

30 titanio
titanium





Lola è sinonimo di versatilità: un design, molteplici applicazioni, per offrire soluzioni illuminotecniche personalizzate e flessibili, ideali per ogni esigenza progettuale. Si inserisce facilmente in numerosi contesti, dal retail, all'hospitality, al residenziale grazie al suo design caratterizzato da linee compatte, all'elegante forma cilindrica della testa e alla possibilità di orientamento del fascio luminoso. Il modello con base si applica a soffitto o parete, mentre la versione con rosone ad incasso è studiata appositamente per locali con controsoffitti. Le ottiche arretrate e lo snoot di serie consentono di ridurre l'abbagliamento al minimo. Disponibile nelle finiture bianco, nero, bronzo, ottone satinato e titanio. Tutte le versioni sono fornite complete di driver.

Lola is synonym of versatility: one design, multiple applications, to offer personalized and flexible lighting solution, ideal for every interior design need. It can be used in a number of project environments, from retail to hospitality to residential, thanks to its design characterized by compact lines, the elegant cylindrical form of the head and the possibility of adjusting the light direction. The version with the base can be installed on the ceiling or wall, whereas the version with the recessed canopy is engineered specifically for rooms with drywall false ceiling. The recessed lense and the snoot allow to minimize the glaring. Available in finishes white, black, bronze, matte brass and titanium. All versions are provided complete with power supply.

	CODICE CODE	FONTI LUMINOSE LIGHT SOURCES	kg
	P12001.020.1704 P12002.020.1704 P12017.020.1704 P12019.020.1704 P12030.020.1704	Potenza assorbita apparecchio / Luminaire power consumption 9W Flusso luminoso apparecchio / Luminaire luminous flux 972lm 2700K Ra>90 24° 220-240V AC dimmable (phase cut) LED IP20 850° Diametro consigliato del corrugato max 20mm Recommended corrugated pipe diameter max 20mm	0,60
	P12001.020.2504 P12002.020.2504 P12017.020.2504 P12019.020.2504 P12030.020.2504	Potenza assorbita apparecchio / Luminaire power consumption 9W Flusso luminoso apparecchio / Luminaire luminous flux 972lm 3000K Ra>90 24° 220-240V AC dimmable (phase cut) LED IP20 850° Diametro consigliato del corrugato max 20mm Recommended corrugated pipe diameter max 20mm	0,60
	X12001.020.3602 X12002.020.3602 X12017.020.3602 X12019.020.3602 X12030.020.3602	Potenza assorbita apparecchio / Luminaire power consumption 18W Flusso luminoso apparecchio / Luminaire luminous flux 1995lm 2700K Ra>85 24° 500mA DC dimmable (DALI/Push DIM) LED IP20 850° Fornito completo di driver DALI/Push DIM Supplied with DALI/Push DIM driver	0,52
	X12001.020.4002 X12002.020.4002 X12017.020.4002 X12019.020.4002 X12030.020.4002	Potenza assorbita apparecchio / Luminaire power consumption 18W Flusso luminoso apparecchio / Luminaire luminous flux 1995lm 3000K Ra>85 24° 500mA DC dimmable (DALI/Push DIM) LED IP20 850° Fornito completo di driver DALI/Push DIM Supplied with DALI/Push DIM driver	0,52

Fotometrie disponibili www.panzeri.it / Photometric data available at www.panzeri.it UGR < 12 in funzione delle condizioni di installazione / UGR < 12 depending on installation conditions

CODICI COLORI DISPONIBILI / COLOUR CODES AVAILABLE

- 01** bianco white
- 02** nero black
- 17** bronzo bronze
- 19** ottone satinato matte brass
- 30** titanio titanium





La tradizione nella lavorazione a mano del vetro soffiato dà vita alla famiglia Murané, una serie di corpi illuminanti installabili a sospensione sia come elementi singoli che secondo composizioni personalizzate, oppure applicabili a soffitto e parete, in appoggio o parzialmente incassati. Il diffusore sferico in vetro in diverse finiture è lavorato internamente, con un effetto ondulato di grande impatto decorativo. La sorgente LED di piccole dimensioni è mascherata da un'apposita copertura in policarbonato, che contribuisce a una diffusione ottimale del fascio luminoso. Le versioni a sospensione sono disponibili con rosone oppure per l'abbinamento con rosoni per sospensioni multiple o a scomparsa.

The tradition in the hand-made craftsmanship of blown glass gives birth to Murané, a series of fittings to install as individual suspensions or customized clusters, on surface or as partially recessed wall-ceiling mount fitting. The spherical diffuser in transparent, in different colours, glass is hand-crafted with a wavy effect of great decorative effect. The LED source is minimal and hidden in a polycarbonate cover, that ensures an optimal light diffusion. The suspension versions are available with individual canopy or without, in order to be combined with recessed or cluster canopies.

CODICE CODE	FONTI LUMINOSE LIGHT SOURCES	kg
----------------	---------------------------------	----

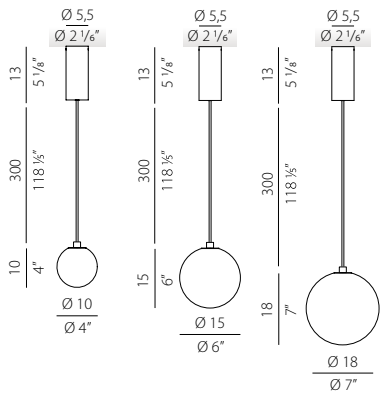

	L11305.010.0501 vetro caramello / caramel glass	0,78
	L11405.010.0501 vetro rosa / pink glass	
	L11505.010.0501 vetro bronzo / bronze glass	
	L11705.010.0501 vetro trasparente / transparent glass	
	L11805.010.0501 vetro fumè / smoke grey glass	
L11905.010.0501 vetro verde foresta / forest green glass		
	L11305.015.0501 vetro caramello / caramel glass	1,12
	L11405.015.0501 vetro rosa / pink glass	
	L11505.015.0501 vetro bronzo / bronze glass	
	L11705.015.0501 vetro trasparente / transparent glass	
	L11805.015.0501 vetro fumè / smoke grey glass	
L11905.015.0501 vetro verde foresta / forest green glass		
	L11305.018.0501 vetro caramello / caramel glass	1,48
	L11405.018.0501 vetro rosa / pink glass	
	L11505.018.0501 vetro bronzo / bronze glass	
	L11705.018.0501 vetro trasparente / transparent glass	
	L11805.018.0501 vetro fumè / smoke grey glass	
L11905.018.0501 vetro verde foresta / forest green glass		

Potenza assorbita apparecchio / Luminaire power consumption 4W
Flusso luminoso apparecchio / Luminaire luminous flux 167lm
2700K Ra>90 220-240V AC ON-OFF

IP20

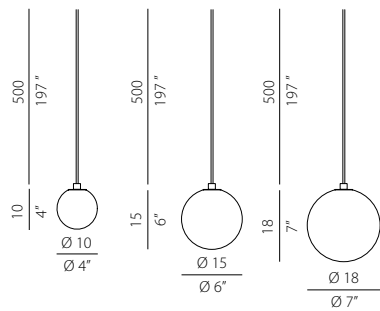

	M11305.010.0501 vetro caramello / caramel glass	0,53
	M11405.010.0501 vetro rosa / pink glass	
	M11505.010.0501 vetro bronzo / bronze glass	
	M11705.010.0501 vetro trasparente / transparent glass	
	M11805.010.0501 vetro fumè / smoke grey glass	
M11905.010.0501 vetro verde foresta / forest green glass		
	M11305.015.0501 vetro caramello / caramel glass	0,87
	M11405.015.0501 vetro rosa / pink glass	
	M11505.015.0501 vetro bronzo / bronze glass	
	M11705.015.0501 vetro trasparente / transparent glass	
	M11805.015.0501 vetro fumè / smoke grey glass	
M11905.015.0501 vetro verde foresta / forest green glass		
	M11305.018.0501 vetro caramello / caramel glass	1,23
	M11405.018.0501 vetro rosa / pink glass	
	M11505.018.0501 vetro bronzo / bronze glass	
	M11705.018.0501 vetro trasparente / transparent glass	
	M11805.018.0501 vetro fumè / smoke grey glass	
M11905.018.0501 vetro verde foresta / forest green glass		

Potenza assorbita apparecchio / Luminaire power consumption 2,7W
Flusso luminoso apparecchio / Luminaire luminous flux 167lm
2700K Ra>90 220-240V AC ON-OFF

IP20

Fornito senza rosone e driver, per composizioni multiple
Supplied without canopy and driver, for multiple configurations

MURANÉ

Matteo Thun e Benedetto Fasciana 2022

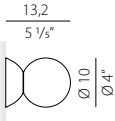
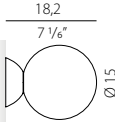
	CODICE CODE	FONTI LUMINOSE LIGHT SOURCES	kg
	P11305.010.0501	vetro caramello / caramel glass	0,42
	P11405.010.0501	vetro rosa / pink glass	
	P11505.010.0501	vetro bronzo / bronze glass	
	P11805.010.0501	vetro fumè / smoke grey glass	
	P11905.010.0501	vetro verde foresta / forest green glass	
	P11305.015.0501	vetro caramello / caramel glass	0,76
	P11405.015.0501	vetro rosa / pink glass	
	P11505.015.0501	vetro bronzo / bronze glass	
	P11805.015.0501	vetro fumè / smoke grey glass	
	P11905.015.0501	vetro verde foresta / forest green glass	

Potenza assorbita apparecchio / Luminaire power consumption 4W
 Flusso luminoso apparecchio / Luminaire luminous flux 167lm
 2700K Ra>90 220-240V AC ON-OFF

 **IP20**
 Fornito completo di driver ON-OFF integrato
 Supplied with built-in ON-OFF driver

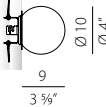
	X11305.010.0501	vetro caramello / caramel glass	0,42
	X11405.010.0501	vetro rosa / pink glass	
	X11505.010.0501	vetro bronzo / bronze glass	
	X11805.010.0501	vetro fumè / smoke grey glass	
	X11905.010.0501	vetro verde foresta / forest green glass	
	X11305.015.0501	vetro caramello / caramel glass	0,76
	X11405.015.0501	vetro rosa / pink glass	
	X11505.015.0501	vetro bronzo / bronze glass	
	X11805.015.0501	vetro fumè / smoke grey glass	
	X11905.015.0501	vetro verde foresta / forest green glass	

Potenza assorbita apparecchio / Luminaire power consumption 4W
 Flusso luminoso apparecchio / Luminaire luminous flux 167lm
 2700K Ra>90 24V DC ON-OFF

 **IP20**
 Fornito completo di driver ON-OFF
 Supplied with ON-OFF driver

Fotometrie disponibili www.panzeri.it / Photometric data available at www.panzeri.it

CODICI COLORI DISPONIBILI / COLOUR CODES AVAILABLE

COLORE VETRI / GLASSES COLOUR

05 champagne
champagne

113 caramello
caramel

114 rosa
pink

115 bronzo
bronze

117 trasparente
transparent

118 fumè
smoke grey

119 verde foresta
forest green



ROSONI E DECENTRAMENTI A PAGINA 105 / OFFSET AND CANOPIES PAGE 105

VERSIONE PER BINARIO STREET A PAGINA 173 / STREET TRACK VERSION ON PAGE 173



Estensione della famiglia Murané articolata in composizioni di sfere luminose disposte a corona. Gli anelli sono proposti in due formati e possono a loro volta essere combinati per creare delle sovrapposizioni verticali di più elementi. Struttura portante in alluminio estruso disponibile in finitura champagne. Corona di diffusori sferici in vetro soffiato color bronzo trasparente. Accessori di alimentazione e fissaggio da ordinare separatamente, che comprendono rosone, cavo di alimentazione e funi con dispositivi di ancoraggio al soffitto. Per la sovrapposizione di più elementi è obbligatorio ordinare l'apposito accessorio di alimentazione e fissaggio aggiuntivo. Possibilità di realizzare composizioni custom con un numero maggiore di anelli.

Extension of the series Murané made of circular compositions of luminous spheres. The rings are available in two dimensions and they allow to create vertical configurations of multiple suspensions. The ring is made of extruded aluminum in champagne finishing. Spherical diffusers in transparent bronze blown glass. Accessories for power supply and hanging to be ordered separately, and include canopy, power cable, steel ropes with devices for ceiling fixing. For laying out more elements it is mandatory to order the additional accessory including power cable and steel ropes. Possibility to realize custom compositions with an increased number of rings.

CODICE CODE	FONTI LUMINOSE LIGHT SOURCES	kg
M19105.080.0510	vetro caramello / caramel glass	8,19
M19305.080.0510	vetro rosa / pink glass	
M11605.080.0510	vetro bronzo / bronze glass	
M19505.080.0510	vetro fumè / smoke grey glass	
M19705.080.0510	vetro verde foresta / forest green glass	
Potenza assorbita apparecchio / Luminaire power consumption 48W Flusso luminoso apparecchio / Luminaire luminous flux 2647lm 2700K Ra>90 24V DC IP20		
Necessario acquistare separatamente kit di alimentazione e sospensione YFR11605.075.A02 per uso singolo o accessori per composizioni multiple (p.63) Power supply and suspension kit YFR11605.075.A02 for single use or accessories for multiple configurations (p.63) to be purchased separately		

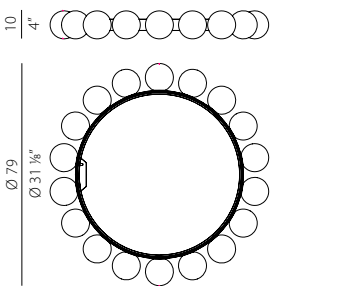

M19105.110.0510	vetro caramello / caramel glass	10,30
M19305.110.0510	vetro rosa / pink glass	
M11605.110.0510	vetro bronzo / bronze glass	
M19505.110.0510	vetro fumè / smoke grey glass	
M19705.110.0510	vetro verde foresta / forest green glass	
Potenza assorbita apparecchio / Luminaire power consumption 66W Flusso luminoso apparecchio / Luminaire luminous flux 3677lm 2700K Ra>90 24V DC IP20		
Necessario acquistare separatamente kit di alimentazione e sospensione YFR11605.075.A02 per uso singolo o accessori per composizioni multiple (p.63) Power supply and suspension kit YFR11605.075.A02 for single use or accessories for multiple configurations (p.63) to be purchased separately		

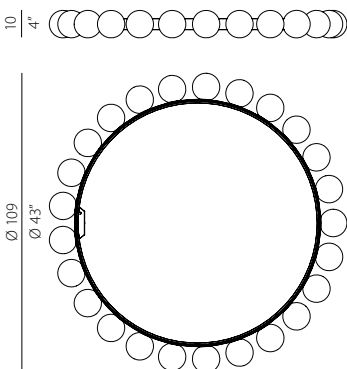

Fotometrie disponibili www.panzeri.it / Photometric data available at www.panzeri.it

CODICI COLORI DISPONIBILI / COLOUR CODES AVAILABLE

COLORE VETRI / GLASSES COLOUR

05 champagne
champagne

191 caramello
caramel

193 rosa
pink

116 bronzo
bronze

195 fumè
smoke grey

197 verde foresta
forest green



MURANÉ

Matteo Thun e Benedetto Fasciana 2022

	CODICE CODE	FONTI LUMINOSE LIGHT SOURCES	kg
	M19005.110.0510 M19205.110.0510 M10605.110.0510 M19405.110.0510 M19605.110.0510	vetro caramello / caramel glass vetro rosa / pink glass vetro bronzo / bronze glass vetro fumè / smoke grey glass vetro verde foresta / forest green glass Potenza assorbita apparecchio / Luminaire power consumption 21W Flusso luminoso apparecchio / Luminaire luminous flux 1177lm 2700K Ra>90 24V DC LED IP20	
	M19005.120.0510 M19205.120.0510 M10605.120.0510 M19405.120.0510 M19605.120.0510	vetro caramello / caramel glass vetro rosa / pink glass vetro bronzo / bronze glass vetro fumè / smoke grey glass vetro verde foresta / forest green glass Potenza assorbita apparecchio / Luminaire power consumption 21W Flusso luminoso apparecchio / Luminaire luminous flux 1177lm 2700K Ra>90 24V DC LED IP20	
	M19005.140.0510 M19205.140.0510 M10605.140.0510 M19405.140.0510 M19605.140.0510	vetro caramello / caramel glass vetro rosa / pink glass vetro bronzo / bronze glass vetro fumè / smoke grey glass vetro verde foresta / forest green glass Potenza assorbita apparecchio / Luminaire power consumption 32W Flusso luminoso apparecchio / Luminaire luminous flux 1765lm 2700K Ra>90 24V DC LED IP20	
	M19005.150.0510 M19205.150.0510 M10605.150.0510 M19405.150.0510 M19605.150.0510	vetro caramello / caramel glass vetro rosa / pink glass vetro bronzo / bronze glass vetro fumè / smoke grey glass vetro verde foresta / forest green glass Potenza assorbita apparecchio / Luminaire power consumption 32W Flusso luminoso apparecchio / Luminaire luminous flux 1765lm 2700K Ra>90 24V DC LED IP20	

Fotometrie disponibili www.panzeri.it / Photometric data available at www.panzeri.it

CODICI COLORI DISPONIBILI / COLOUR CODES AVAILABLE

COLORE VETRI / GLASSES COLOUR

05 champagne
champagne

190 caramello
caramel

192 rosa
pink

106 bronzo
bronze

194 fumè
smoke grey

196 verde foresta
forest green



	CODICE CODE	FONTI LUMINOSE LIGHT SOURCES	kg
	YFR11605.075.A02	<p>Kit di alimentazione e sospensione con rosone champagne, alimentatore 75W dimmerabile DALI/Push DIM, cavo di alimentazione di lunghezza 5m (196,9"), dispositivi di regolazione rapida e funi in acciaio di lunghezza 5m (196,9"). Rosone per collegamento elettrico di 1 modello M116__080.0510 o 1 modello M116__110.0510.</p> <p>Power supply and suspension kit with champagne, 75W DALI/Push DIM dimmable driver, 5m (196,9") long power cable, griplocks and 5m (196,9") long steel cables. Canopy for power supply up to 1 M116__080.0510 or 1 M116__110.0510 model.</p>	1,76
	YFR11605.180.A02	<p>Kit di alimentazione e sospensione con rosone champagne, alimentatore 180W dimmerabile DALI/Push DIM, cavo di alimentazione di lunghezza 5m (196,9"), dispositivi di regolazione rapida e funi in acciaio di lunghezza 5m (196,9"). Rosone per collegamento elettrico di massimo 3 modelli M116__080.0510 o 2 modelli M116__110.0510.</p> <p>Power supply and suspension kit with champagne, 180W DALI/Push DIM dimmable driver, 5m (196,9") long power cable, griplocks and 5m (196,9") long steel cables. Canopy for power supply up to 3 M116__080.0510 or 2 M116__110.0510 models maximum.</p>	4,74
	YFS11601.500 YFS11605.500	<p>Kit di sospensione con 3 funi in acciaio di lunghezza 5m (196,9"), dispositivi di regolazione rapida e cavo di alimentazione di lunghezza 5m (196,9"), per l'installazione dei modelli M106 o M116. Driver non incluso.</p> <p>Suspension kit of 3 steel cables 5m (196,9") long, griplocks and 5m (196,9") long power cable, for installation of M106 or M116 model. Driver not included</p>	
	YFA11600.010	<p>Kit di alimentazione e sospensione per installazioni multiple con cavo di alimentazione di lunghezza 20cm (7,9") e funi in acciaio di lunghezza 8cm (3,1").</p> <p>Multiple power supply and suspension kit with 20cm (7,9") long power cable and 8cm (3,1") long steel cables.</p>	0,01
	YFA11600.025	<p>Kit di alimentazione e sospensione per installazioni multiple con cavo di alimentazione di lunghezza 30cm (11,8") e funi in acciaio di lunghezza 27cm (10,6").</p> <p>Multiple power supply and suspension kit with 30cm (11,8") long power cable and 27cm (10,6") long steel cables.</p>	0,02

COMPOSIZIONI MURANÉ R - MURANÉ R CONFIGURATIONS

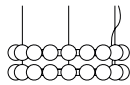
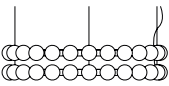
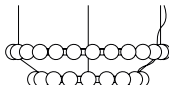
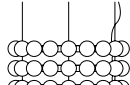
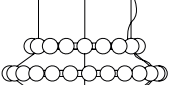
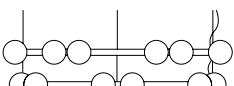
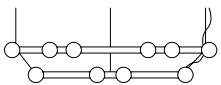
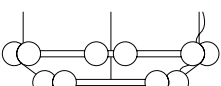
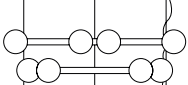
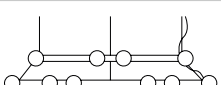
COMPOSIZIONI CONFIGURATIONS	APPARECCHI FIXTURES	YFR11605.075.A02 KIT ALIMENTAZIONE E SOSPENSIONE 75W 75W FEEDING AND SUSPENSION KIT	YFR11605.180.A02 KIT ALIMENTAZIONE E SOSPENSIONE 180W 180W FEEDING AND SUSPENSION KIT	YFA11600.010 KIT SOSPENSIONE E CONNESSIONE 10cm 10cm SUSPENSION AND CONNECTION KIT	YFA11600.025 KIT SOSPENSIONE E CONNESSIONE 25cm 25cm SUSPENSION AND CONNECTION KIT
01 	n.2 M11605.080.0510		n.1	n.1	
02 	n.2 M11605.110.0510		n.1	n.1	
03 	n.1 M11605.110.0510 n.1 M11605.080.0510		n.1		n.1
04 	n.3 M11605.080.0510		n.1	n.2	
05 	n.2 M11605.080.0510 n.1 M11605.110.0510		n.1		n.2
06 	n.2 M10605.120.0510	n.1			n.1
07 	n.2 M10605.150.0510	n.1			n.1
08 	n.1 M10605.140.0510 n.1 M10605.110.0510	n.1			n.1
09 	n.1 M10605.150.0510 n.1 M10605.120.0510	n.1			n.1
10 	n.3 M10605.120.0510	n.1			n.2
11 	n.3 M10605.150.0510		n.1		n.2
12 	n.2 M10605.110.0510 n.1 M10605.140.0510		n.1		n.2
13 	n.2 M10605.120.0510 n.1 M10605.150.0510		n.1		n.2



OLIVIA, EMMA E CLIO

Silvia Poma 2017



Lampada a sospensione in vetro soffiato con particolare finitura a coste dal gusto retrò. Rosone in metallo rifinito con vernice poliaccrilica in color nero oppure ottone satinato. Emissione di luce diffusa con attacco E27 e lampadina LED con filamenti a vista inclusa. Vetro soffiato disponibile in 7 colorazioni: cristallo, acciaio, ambra, bronzo, tabacco, verde e bianco lucido. Cavi elettrici in tessuto nero con possibilità di personalizzarne la lunghezza. Rosone a 8 uscite (+1 centrale). Ideale per strutture hospitality o zone living residenziali.

Suspension lamp with shaded blown glass with a retro style. Ceiling metal canopy in black polyacrylic paint and in matte brass. Diffused light in LED bulb E27 distinguished by visible filaments. Seven colors glass available: crystal, steel, amber, bronze, tobacco, green and glossy white. Black fabric electrical cables and possibility to customize the length. Canopy with 8 outputs (+1 in the center). Ideal for hospitality or residential facilities.

CODICE CODE	FONTI LUMINOSE LIGHT SOURCES	kg
-------------	------------------------------	----

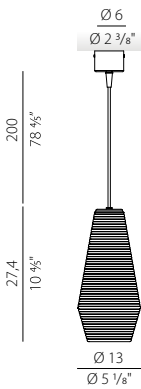

- L09751.000.0200**
- L09752.000.0200**
- L09753.000.0200**
- L09754.000.0200**
- L09755.000.0200**
- L09756.000.0200**
- L09757.000.0200**
- L09771.000.0200**
- L09772.000.0200**
- L09773.000.0200**
- L09774.000.0200**
- L09775.000.0200**
- L09776.000.0200**
- L09777.000.0200**

LED retrofit bulb 8W E27 2700K Ra80 1050lm (no dimming) max 57W E27
IP20
 Sorgente luminosa LED inclusa
 LED bulb included

0,95

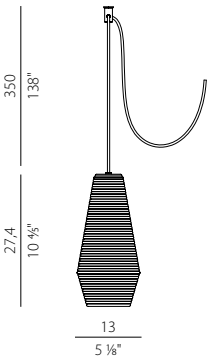

- M09751.000.0200**
- M09752.000.0200**
- M09753.000.0200**
- M09754.000.0200**
- M09755.000.0200**
- M09756.000.0200**
- M09757.000.0200**
- M09771.000.0200**
- M09772.000.0200**
- M09773.000.0200**
- M09774.000.0200**
- M09775.000.0200**
- M09776.000.0200**
- M09777.000.0200**

LED retrofit bulb 8W E27 2700K Ra80 1050lm (no dimming) max 57W E27
IP20
 Fornito senza rosone, con cavo di collegamento 3,5m e appendimento M800, per composizioni multiple. Sorgente luminosa LED inclusa
 Supplied without canopy, with 3,5m cable and M800 polycarbonate hook for multiple configurations. LED bulb included

0,92

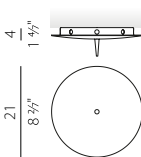

- M91/94/9702**
- M91/94/9719**

Rosone per collegamento elettrico di massimo 9 modelli M091__000.0200/ M094__000.0200/M097__000.0200.
 Canopy for power supply up to 9 M091__000.0200/M094__000.0200/ M097__000.0200 models maximum.

0,50

Fotometrie disponibili www.panzeri.it / Photometric data available at www.panzeri.it

CODICI COLORI DISPONIBILI / COLOUR CODES AVAILABLE

- | | | | | | | |
|--|---|---|---|---|---|---|
| 51 nero
diffusore bianco
black/white diffuser | 52 nero
diffusore trasparente
black/transparent
diffuser | 53 nero
diffusore fumè
black/smoke grey
diffuser | 54 nero
diffusore ambra
black/amber diffuser | 55 nero
diffusore bronzo
black/bronze diffuser | 56 nero
diffusore tabacco
black/tobacco diffuser | 57 nero
diffusore verde
black/green diffuser |
| 71 ottone satinato
diffusore bianco
matte brass
white diffuser | 72 ottone satinato
diffusore trasparente
matte brass
transparent diffuser | 73 ottone satinato
diffusore fumè
matte brass
smoke grey diffuser | 74 ottone satinato
diffusore ambra
matte brass
amber diffuser | 75 ottone satinato
diffusore bronzo
matte brass
bronze diffuser | 76 ottone satinato
diffusore tabacco
matte brass
tobacco diffuser | 77 ottone satinato
diffusore verde
matte brass
green diffuser |



ROSONI E DECENTRAMENTI A PAGINA 105 / OFFSET AND CANOPIES PAGE 105



OLIVIA, EMMA E CLIO

Silvia Poma 2015

Registered Design



Lampada a sospensione in vetro soffiato con particolare finitura a coste dal gusto retrò. Rosone in metallo rifinito con vernice poliaccrilica in color nero oppure ottone satinato. Emissione di luce diffusa con attacco E27 e lampadina LED con filamenti a vista inclusa. Vetro soffiato disponibile in 7 colorazioni: cristallo, acciaio, ambra, bronzo, tabacco, verde e bianco lucido. Cavi elettrici in tessuto nero con possibilità di personalizzarne la lunghezza. Rosone a 8 uscite (+1 centrale). Ideale per strutture hospitality o zone living residenziali.

Suspension lamp with shaded blown glass with a retro style. Ceiling metal canopy in black polyacrylic paint and in matte brass. Diffused light in LED bulb E27 distinguished by visible filaments. Seven colors glass available: crystal, steel, amber, bronze, tobacco, green and glossy white. Black fabric electrical cables and possibility to customize the length. Canopy with 8 outputs (+1 in the center). Ideal for hospitality or residential facilities.

	CODICE CODE	FONTE LUMINOSE LIGHT SOURCES	kg
	L09151.000.0200	LED retrofit bulb 8W E27 2700K Ra80 1050lm (no dimming)	1,50
	L09152.000.0200	max 57W E27	
	L09153.000.0200	IP20	
	L09154.000.0200	Sorgente luminosa LED inclusa	
	L09155.000.0200	LED bulb included	
	L09156.000.0200		
	L09157.000.0200		
	L09171.000.0200		
	L09172.000.0200		
	L09173.000.0200		
	L09174.000.0200		
	L09175.000.0200		
	L09176.000.0200		
	L09177.000.0200		

	M09151.000.0200	LED retrofit bulb 8W E27 2700K Ra80 1050lm (no dimming)	1,47
	M09152.000.0200	max 57W E27	
	M09153.000.0200	IP20	
	M09154.000.0200	Fornito senza rosone, con cavo di collegamento 3,5m e appendimento M800,	
	M09155.000.0200	per composizioni multiple. Sorgente luminosa LED inclusa	
	M09156.000.0200	Supplied without canopy, with 3,5m cable and M800 polycarbonate hook for	
	M09157.000.0200	multiple configurations. LED bulb included	
	M09171.000.0200		
	M09172.000.0200		
	M09173.000.0200		
	M09174.000.0200		
	M09175.000.0200		
	M09176.000.0200		
	M09177.000.0200		

	M91/94/9702	Rosone per collegamento elettrico di massimo 9 modelli M091__000.0200/	0,50
	M91/94/9719	M094__000.0200/M097__000.0200. Canopy for power supply up to 9 M091 __000.0200/M094__000.0200/ M097__000.0200 models maximum.	

Fotometrie disponibili www.panzeri.it / Photometric data available at www.panzeri.it

CODICI COLORI DISPONIBILI / COLOUR CODES AVAILABLE

51 nero diffusore bianco black/white diffuser	52 nero diffusore trasparente black/transparent diffuser	53 nero diffusore fumè black/smoke grey diffuser	54 nero diffusore ambra black/amber diffuser	55 nero diffusore bronzo black/bronze diffuser	56 nero diffusore tabacco black/tobacco diffuser	57 nero diffusore verde black/green diffuser
71 ottone satinato diffusore bianco matte brass white diffuser	72 ottone satinato diffusore trasparente matte brass transparent diffuser	73 ottone satinato diffusore fumè matte brass smoke grey diffuser	74 ottone satinato diffusore ambra matte brass amber diffuser	75 ottone satinato diffusore bronzo matte brass bronze diffuser	76 ottone satinato diffusore tabacco matte brass tobacco diffuser	77 ottone satinato diffusore verde matte brass green diffuser



ROSONI E DECENTRAMENTI A PAGINA 105 / OFFSET AND CANOPIES PAGE 105



OLIVIA, EMMA E CLIO

Silvia Poma 2015

Registered Design



Lampada a sospensione in vetro soffiato con particolare finitura a coste dal gusto retrò. Rosone in metallo rifinito con vernice poliaccrilica in color nero oppure ottone satinato. Emissione di luce diffusa con attacco E27 e lampadina LED con filamenti a vista inclusa. Vetro soffiato disponibile in 7 colorazioni: cristallo, acciaio, ambra, bronzo, tabacco, verde e bianco lucido. Cavi elettrici in tessuto nero con possibilità di personalizzarne la lunghezza. Rosone a 8 uscite (+1 centrale). Ideale per strutture hospitality o zone living residenziali.

Suspension lamp with shaded blown glass with a retro style. Ceiling metal canopy in black polyacrylic paint and in matte brass. Diffused light in LED bulb E27 distinguished by visible filaments. Seven colors glass available: crystal, steel, amber, bronze, tobacco, green and glossy white. Black fabric electrical cables and possibility to customize the length. Canopy with 8 outputs (+1 in the center). Ideal for hospitality or residential facilities.

CODICE CODE	FONTI LUMINOSE LIGHT SOURCES	kg
-------------	------------------------------	----

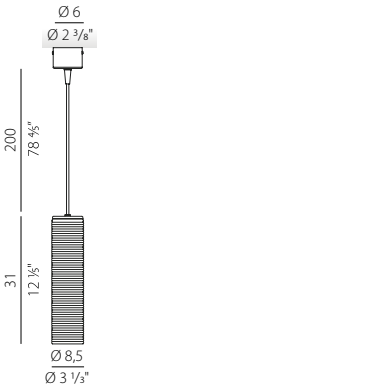

	L09451.000.0200 L09452.000.0200 L09453.000.0200 L09454.000.0200 L09455.000.0200 L09456.000.0200 L09457.000.0200 L09471.000.0200 L09472.000.0200 L09473.000.0200 L09474.000.0200 L09475.000.0200 L09476.000.0200 L09477.000.0200	LED retrofit bulb 8W E27 2700K Ra80 1050lm (no dimming) max 57W E27 IP20 Sorgente luminosa LED inclusa LED bulb included	1,32
--	--	--	------

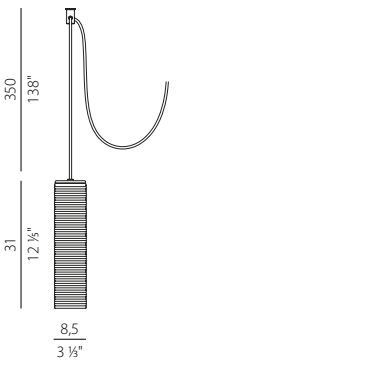

	M09451.000.0200 M09452.000.0200 M09453.000.0200 M09454.000.0200 M09455.000.0200 M09456.000.0200 M09457.000.0200 M09471.000.0200 M09472.000.0200 M09473.000.0200 M09474.000.0200 M09475.000.0200 M09476.000.0200 M09477.000.0200	LED retrofit bulb 8W E27 2700K Ra80 1050lm (no dimming) max 57W E27 IP20 Fornito senza rosone, con cavo di collegamento 3,5m e appendimento M800, per composizioni multiple. Sorgente luminosa LED inclusa Supplied without canopy, with 3,5m cable and M800 polycarbonate hook for multiple configurations. LED bulb included	1,29
--	--	--	------

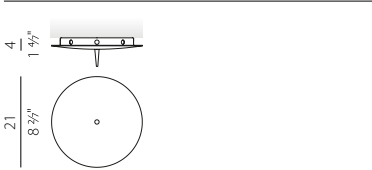

M91/94/9702 M91/94/9719	Rosone per collegamento elettrico di massimo 9 modelli M091__000.0200/ M094__000.0200/M097__000.0200. Canopy for power supply up to 9 M091__000.0200/M094__000.0200/ M097__000.0200 models maximum.	0,50
--	--	------

Fotometrie disponibili www.panzeri.it / Photometric data available at www.panzeri.it

CODICI COLORI DISPONIBILI / COLOUR CODES AVAILABLE

51 nero diffusore bianco black/white diffuser	52 nero diffusore trasparente black/transparent diffuser	53 nero diffusore fumè black/smoke grey diffuser	54 nero diffusore ambra black/amber diffuser	55 nero diffusore bronzo black/bronze diffuser	56 nero diffusore tabacco black/tobacco diffuser	57 nero diffusore verde black/green diffuser
71 ottone satinato diffusore bianco matte brass white diffuser	72 ottone satinato diffusore trasparente matte brass transparent diffuser	73 ottone satinato diffusore fumè matte brass smoke grey diffuser	74 ottone satinato diffusore ambra matte brass amber diffuser	75 ottone satinato diffusore bronzo matte brass bronze diffuser	76 ottone satinato diffusore tabacco matte brass tobacco diffuser	77 ottone satinato diffusore verde matte brass green diffuser



ROSONI E DECENTRAMENTI A PAGINA 105 / OFFSET AND CANOPIES PAGE 105



OMBRA

Jordi Blasi 2025



Ombra nasce dalla sapiente unione della flessibilità del tessuto con la rigidità del metallo. Una gamma di apparecchi decorativi da interno, che comprende versioni da sospensione, parete, tavolo e terra, in cui la luce viene quasi nascosta dal tessuto tecnico del paralume, creando atmosfere suggestive. La sorgente luminosa LED è alloggiata all'interno della struttura di alluminio, disponibile in finitura nero satinato ed ottone satinato. Un sottile e moderno tessuto intrecciato vela la sorgente e diffonde l'emissione luminosa rendendola soffusa e delicata. Le versioni a parete e sospensione disponibili in due dimensioni. Le versioni da tavolo e da terra sono impreziosite dal basamento in marmo nero marquina e dal cavo in tessuto.

Ombra was born from the skilful union of the flexibility of fabric with the rigidity of metal. A range of decorative indoor fixtures, including suspension, wall, table and floor versions, in which the light is almost hidden by the technical fabric of the shade, creating suggestive atmospheres. The LED light source is housed within the aluminium structure, available in matte black and matte brass finishes. A thin, modern woven fabric covers the source and diffuses the light, with a soft and delicate effect. The wall and pendant versions are available in two sizes. The table and floor versions are enriched with a black marquina marble base and fabric cable.

CODICE CODE	FONTE LUMINOSA LIGHT SOURCES	kg
-------------	------------------------------	----

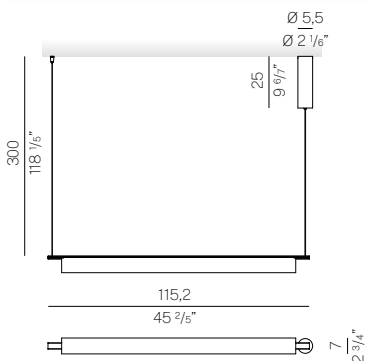

L16006.115.0502

L16019.115.0502

Potenza assorbita apparecchio / Luminaire power consumption 23W
 Flusso luminoso apparecchio / Luminaire luminous flux 1059lm
 2700K Ra>90 220-240V AC dimmable (DALI/Push DIM)

IP20

1,71

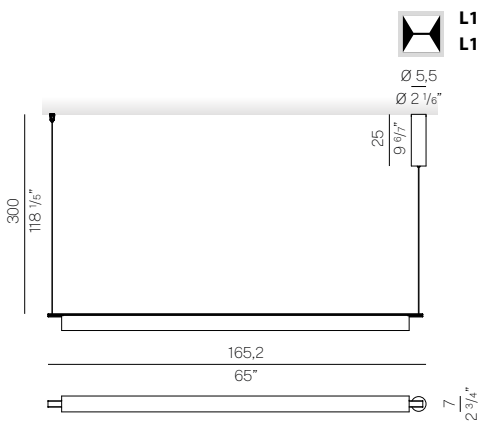

L16006.165.0502

L16019.165.0502

Potenza assorbita apparecchio / Luminaire power consumption 35W
 Flusso luminoso apparecchio / Luminaire luminous flux 1589lm
 2700K Ra>90 220-240V AC dimmable (DALI/Push DIM)

IP20

1,99

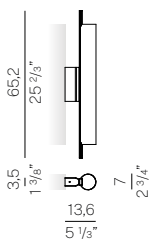

A16006.065.0502

A16019.065.0502

Potenza assorbita apparecchio / Luminaire power consumption 12,2W
 Flusso luminoso apparecchio / Luminaire luminous flux 530lm
 2700K Ra>90 220-240V AC dimmable (DALI/Push DIM)

IP20

1,18

OMBRA

Jordi Blasi 2025

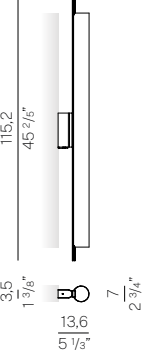
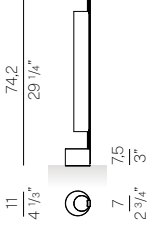
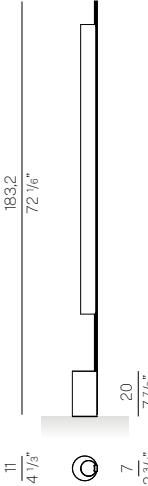
	CODICE CODE	FONTI LUMINOSE LIGHT SOURCES	kg
	A16006.115.0502 A16019.115.0502	Potenza assorbita apparecchio / Luminaire power consumption 23W Flusso luminoso apparecchio / Luminaire luminous flux 1059lm 2700K Ra>90 220-240V AC dimmable (DALI/Push DIM) LED IP20	1,85
	C16006.075.0522 C16019.075.0522	Potenza assorbita apparecchio / Luminaire power consumption 12,2W Flusso luminoso apparecchio / Luminaire luminous flux 530lm 2700K Ra>90 220-240V AC dimmer on cable LED IP20 Base di appoggio in marmo nero marquina. Cavo di alimentazione in tessuto nero Black bearing base in black marquina marble. Black fabric power cable	2,30
	T16006.180.0522 T16019.180.0522	Potenza assorbita apparecchio / Luminaire power consumption 30W Flusso luminoso apparecchio / Luminaire luminous flux 1589lm 2700K Ra>90 220-240V AC dimmer on cable LED IP20 Base di appoggio in marmo nero marquina. Cavo di alimentazione in tessuto nero Black bearing base in black marquina marble. Black fabric power cable	6,93

Fotometrie disponibili www.panzeri.it / Photometric data available at www.panzeri.it

CODICI COLORI DISPONIBILI / COLOUR CODES AVAILABLE

06 nero satinato
matte black

19 ottone satinato
matte brass



archiproducts
AWARDS
WINNER



Famiglia di prodotti da tavolo e parete con struttura snodata per il posizionamento ottimale della fonte luminosa rispetto alla superficie di lavoro, ideale in ambienti lavorativi o per l'illuminazione di tavoli e scrivanie in ambito domestico e hospitality. Il telaio è realizzato in alluminio tubolare con elementi snodati in alluminio pressofuso e tiranti in fune di acciaio; la testa orientabile in pressofusione di alluminio e equipaggiata di sorgente LED con intensità e tonalità di luce regolabili secondo la tecnologia DIM-to-warm; l'elettronica di bordo inoltre è configurabile in modalità bianco dinamico, con luce di colorazione variabile da bianco caldo a bianco naturale. Disponibile versione da tavolo con sensore di presenza. Tutti i modelli sono disponibili con verniciatura poliaccrilica in colore bianco, nero satinato, bronzo, ottone satinato o titanio. Per la versione da tavolo disponibili le nuove finiture verde oliva materico e terracotta naturale materico.

Opuntia is a series of table and wall lamps with jointed structure for optimal positioning of the light source with respect to the working plan, ideal for workstations or for the illumination of tables and desks in home or hospitality settings. The structure is built in tube-shaped aluminum with jointed elements in aluminum die-cast and tie-rods in steel; the adjustable head in aluminum die-cast is equipped with a LED board with technology DIM-to-warm to regulate light intensity and color temperature accordingly; the electronics onboard allow to set also on tunable white, with fixed light intensity and color temperature ranging from warm white to cold white. Presence detector version available. All models are available in polyacrylic paint in finish white, matte black, bronze, matte brass and titanium. For table version, new finishes textured olive green and textured natural terracotta are available.

	CODICE CODE	FONTI LUMINOSE LIGHT SOURCES	kg
	C06801.000.9121	Potenza assorbita apparecchio / Luminaire power consumption 8,5W	3,45
	C06806.000.9121	Flusso luminoso apparecchio / Luminaire luminous flux 700lm	
	C06817.000.9121	2200-4000K Ra>90 220-240V AC DIM-to-warm + tunable white	
	C06819.000.9121	IP40	
	C06827.000.9121		
	C06829.000.9121		
	C06801.000.9121P	Potenza assorbita apparecchio / Luminaire power consumption 8,5W	
	C06806.000.9121P	Flusso luminoso apparecchio / Luminaire luminous flux 700lm	
	C06817.000.9121P	2200-4000K Ra>90 220-240V AC DIM-to-warm + tunable white	
	C06819.000.9121P	IP40	
	C06827.000.9121P	Versione con sensore di presenza	
	C06829.000.9121P	Presence detector version	

	A06801.130.9121	Potenza assorbita apparecchio / Luminaire power consumption 8,5W	1,20
	A06806.130.9121	Flusso luminoso apparecchio / Luminaire luminous flux 700lm	
	A06817.130.9121	2200-4000K Ra>90 220-240V AC DIM-to-warm + tunable white	
	A06819.130.9121	IP40	
	A06830.130.9121		

	A06801.180.9121	Potenza assorbita apparecchio / Luminaire power consumption 8,5W	1,29
	A06806.180.9121	Flusso luminoso apparecchio / Luminaire luminous flux 700lm	
	A06817.180.9121	2200-4000K Ra>90 220-240V AC DIM-to-warm + tunable white	
	A06819.180.9121	IP40	
	A06830.180.9121		

Fotometrie disponibili www.panzeri.it / Photometric data available at www.panzeri.it

CODICI COLORI DISPONIBILI / COLOUR CODES AVAILABLE						
01 bianco white	06 nero satinato matte black	17 bronzo bronze	19 ottone satinato matte brass	27 verde oliva materico textured olive green	29 terracotta naturale materico textured natural terracotta	30 titanio titanium



RENDEZ-VOUS

Philip Platino 2025



Rendez-vous è un apparecchio di illuminazione dalle dimensioni minime realizzato rispettando le proporzioni auree. Prendendo spunto dal concetto di "incontro", può essere utilizzato singolarmente o in composizione multiple scenografiche, in cluster o lineari, realizzabili attraverso l'utilizzo di rosoni e accessori appositamente progettati. La piccola testa conica in pressofusione di alluminio è disponibile in finitura nero satinato e bronzo; nasconde al suo interno una sorgente LED e una lente per direzionare il fascio. Disponibile in versione per binario elettrificato 48V della serie Street.

Rendez-vous is a luminaire with minimal dimensions designed the golden proportions. Taking its cue from the concept of 'encounter', it could be used singly or in multiple scenic compositions, in clusters or linear, which could be realised with specially designed canopies and accessories. The small conical die-cast aluminium head is available in satin black and bronze finishes; it conceals a LED source and a lens to direct the beam. Available in a version for 48V electrified track of the Street series.

CODICE
CODE

FONTI LUMINOSE
LIGHT SOURCES

kg



L08006.007.1701

L08017.007.1701

Potenza assorbita apparecchio / Luminaire power consumption 2W
Flusso luminoso apparecchio / Luminaire luminous flux 111lm
2700K Ra>90 25° 220-240V AC ON-OFF

0,50

IP20

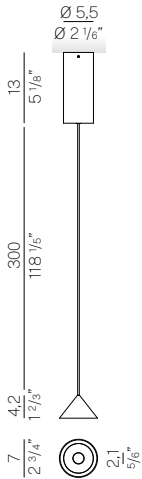

M08006.007.1710

M08017.007.1710

Potenza assorbita apparecchio / Luminaire power consumption 1,6W
Flusso luminoso apparecchio / Luminaire luminous flux 111lm
2700K Ra>90 25° 24V DC

0,40

IP20

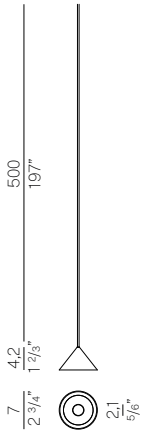

YLN08000.42

Lente per fascio largo
Wide flood lens

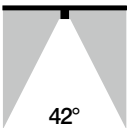

KGA08006.54

KGA08017.54

Kit con griglia anti-abbagliamento in colore nero
Kit with anti-glare grid in black colour

0,05



RENDEZ-VOUS

Officina Panzeri 2025



INSTALLAZIONE CON ROSONI E DECENTRAMENTI / INSTALLATION WITH CANOPIES AND OFFSETS

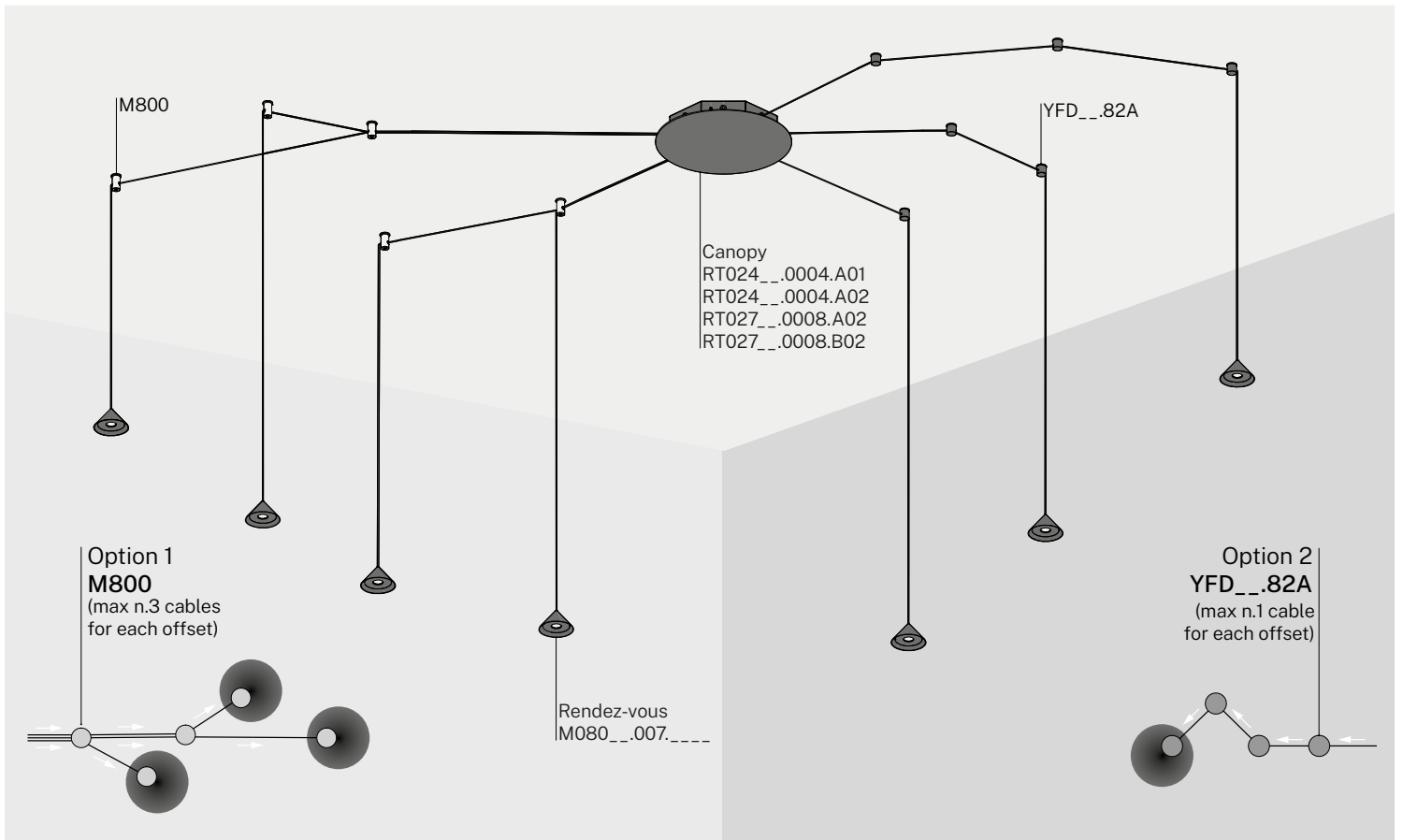

VERSIONE PER BINARIO STREET A PAGINA 174 / STREET TRACK VERSION ON PAGE 174



Una famiglia di prodotti che rappresenta un prestigioso connubio tra classicità e modernità. La sapiente unione di forme che evocano il passato, materiali raffinati e tecnologie contemporanee crea un prodotto senza tempo, in grado di esaltare la texture del vetro cattedrale attraverso una luce morbida e diffusa. Roma diventa assoluta protagonista dello spazio che occupa grazie al suo carattere forte e distintivo. Disponibile in versione sospensione, parete, tavolo e terra, con basamento in metallo oppure in travertino, sia per ambienti interni che esterni.

A family of products that represents a prestigious blend of classicism and modernity. The clever combination of shapes that evoke the past, refined materials and contemporary technology creates a timeless product that enhances the texture of cathedral glass through soft, diffused light. Roma becomes the absolute protagonist of the room thanks to its strong and distinctive character. Available in suspension, wall, table and floor version, for both indoor and outdoor use, with a metal or travertine base.

CODICE CODE	FONTI LUMINOSE LIGHT SOURCES	kg
-------------	------------------------------	----



T14817.185.0527

Potenza assorbita apparecchio / Luminaire power consumption 80W
 Flusso luminoso apparecchio / Luminaire luminous flux 5048lm
 2700K Ra>90 220-240V AC dimmable (Push DIM)

56,00

IP20

Fornito completo di dimmer a sfioramento, cavo 2,5m e spina
 Supplied with dimmer touch, 2,5m cable and plug

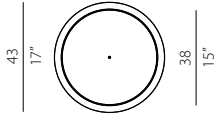
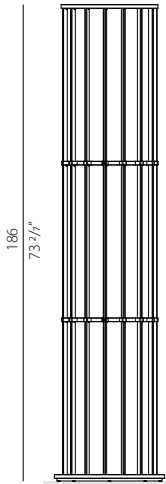

T14817.200.0527

Potenza assorbita apparecchio / Luminaire power consumption 80W
 Flusso luminoso apparecchio / Luminaire luminous flux 5048lm
 2700K Ra>90 220-240V AC dimmable (Push DIM)

72,45

IP20

Base di appoggio in travertino.
 Fornito completo di dimmer a sfioramento, cavo 2,5m e spina
 Travertine base.
 Supplied with dimmer touch, 2,5m cable and plug

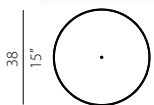
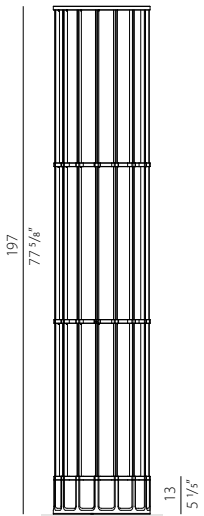

	CODICE CODE	FONTI LUMINOSE LIGHT SOURCES	kg
	L14817.030.0502	Potenza assorbita apparecchio / Luminaire power consumption 39W Flusso luminoso apparecchio / Luminaire luminous flux 2790lm 2700K Ra>90 220-240V AC dimmable (DALI/Push DIM) LED IP20	14,10

	C14817.060.0527	Potenza assorbita apparecchio / Luminaire power consumption 39W Flusso luminoso apparecchio / Luminaire luminous flux 2790lm 2700K Ra>90 220-240V AC dimmable (Push DIM) LED IP20 Fornito completo di dimmer a sfioramento, cavo 1,8m e spina Supplied with dimmer touch, 1,8m cable and plug	14,00
--	------------------------	--	-------

	A14817.036.0502	Potenza assorbita apparecchio / Luminaire power consumption 19W Flusso luminoso apparecchio / Luminaire luminous flux 1416lm 2700K Ra>90 220-240V AC dimmable (DALI/Push DIM) LED IP20	7,35
--	------------------------	---	------

Fotometrie disponibili www.panzeri.it / Photometric data available at www.panzeri.it

CODICI COLORI DISPONIBILI / COLOUR CODES AVAILABLE

17 bronzo
bronze



Roris è una famiglia di apparecchi di illuminazione con un forte carattere decorativo ispirato alla natura, capace di adattarsi ed integrarsi, con le diverse versioni, ad ambienti interni eleganti, minimali e moderni, sia residenziali che commerciali. La famiglia Roris prende spunto dalle forme sottili e flessibili della flora, in un gioco di segni e traiettorie che, con semplicità, arreda e illumina l'ambiente. I 6 bracci curvi delle versioni a plafone e a incasso parziale, distribuiti ritmicamente su un corpo centrale affusolato, portano 8 corpi illuminanti di vetro dalla forma tondeggiante simile gocce di rugiada. Sono disponibili anche le versioni da parete e da tavolo, che illuminano lo spazio in maniera diffusa. Tutte le versioni disponibili in finitura nero satinato e ottone satinato.

Roris is a family of lighting fixtures with a strong decorative character inspired by nature, capable of adapting and integrating, with its different versions, into elegant, minimalist and modern interiors, both residential and commercial. The Roris family comes from the thin and flexible forms of flora, in a play of signs and trajectories that simply furnish and illuminate the environment. The 6 curved arms of the surface-mounted and partially recessed versions, rhythmically distributed over a tapered central body, carry 8 glass light fittings with a rounded dewdrop-like shape. Wall and table versions are also available, illuminating the space in a diffuse manner. All versions are available in matte black and matte brass finishes.

CODICE CODE	FONTI LUMINOSE LIGHT SOURCES	kg
-------------	------------------------------	----



X11206.008.0500

X11219.008.0500

8x LED retrofit bulb 3W G9 2700K Ra80 250lm dimmable max 4W G9

2,82

Potenza assorbita apparecchio / Luminaire power consumption 24W
Flusso luminoso apparecchio / Luminaire luminous flux 1272lm
220-240V AC

IP20

Sorgente luminosa LED inclusa
LED bulb included

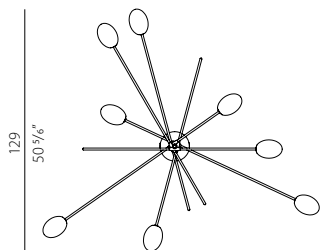
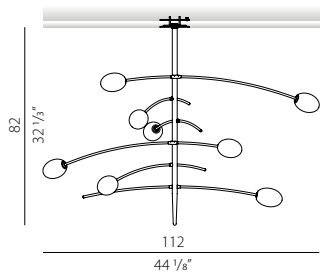

P11206.008.0500

P11219.008.0500

8x LED retrofit bulb 3W G9 2700K Ra80 250lm dimmable max 4W G9

2,71

Potenza assorbita apparecchio / Luminaire power consumption 24W
Flusso luminoso apparecchio / Luminaire luminous flux 1272lm
220-240V AC

IP20

Sorgente luminosa LED inclusa
LED bulb included

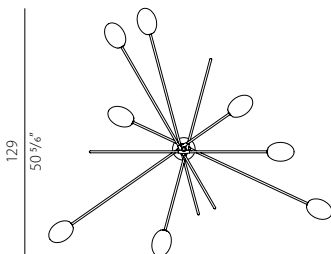
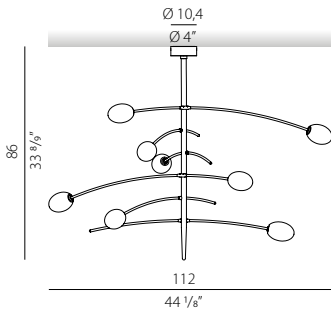

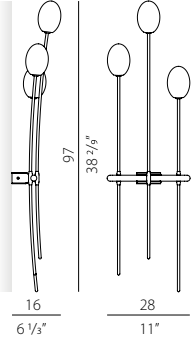
	CODICE CODE	FONTI LUMINOSE LIGHT SOURCES	kg
	A11206.003.0500 A11219.003.0500	3x LED retrofit bulb 3W G9 2700K Ra80 250lm dimmable max 4W G9 Potenza assorbita apparecchio / Luminaire power consumption 9W Flusso luminoso apparecchio / Luminaire luminous flux 545lm 220-240V AC IP20 Sorgente luminosa LED inclusa LED bulb included	1,14

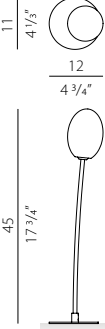
	C11206.001.0500 C11219.001.0500	1x LED retrofit bulb 3W G9 2700K Ra80 250lm max 4W G9 Potenza assorbita apparecchio / Luminaire power consumption 3W Flusso luminoso apparecchio / Luminaire luminous flux 182lm 220-240V AC IP20 Sorgente luminosa LED inclusa LED bulb included	0,48
--	--	---	------

Fotometrie disponibili www.panzeri.it / Photometric data available at www.panzeri.it

CODICI COLORI DISPONIBILI / COLOUR CODES AVAILABLE

06 nero satinato
matte black

19 ottone satinato
matte brass





SCENT

Marc Sadler 2026



Scent unisce la precisione di un prodotto tecnico al calore di un oggetto d'arte. Il suo design trae ispirazione dall'estetica ricercata dei flaconi di profumo: le preziose sfaccettature del vetro a rilievo giocano con i riflessi, trasformando la luce in una materia viva che vibra nell'ambiente come una fragranza impalpabile. Disponibile come sospensione singola o nelle dinamiche versioni a binario, Scent permette di vestire ogni spazio con un'identità unica grazie a una palette cromatica concepita come vero strumento progettuale. Regala un comfort visivo assoluto e un'aura soffusa che, proprio come un profumo, lascia un'impronta invisibile ma memorabile.

Scent combines the precision of a technical product with the warmth of an artistic creation. Drawing inspiration from the sophisticated aesthetic of perfume bottles, its design features precious pressed glass facets that play with reflections, transforming light into living matter that vibrates within the space like an intangible fragrance. Available as a single suspension or in dynamic track versions, Scent enables any space to be adorned with a distinctive character through its curated colour palette. Providing absolute visual comfort, it emits a soft aura that leaves an invisible yet memorable imprint on the environment, much like a perfume.

NEW	CODICE CODE	FONTI LUM INOSE LIGHT SOURCES	kg
	L30106.V17.1701	Potenza assorbita apparecchio / Luminaire power consumption 9W	0,69
	L30106.V08.1701	Flusso luminoso apparecchio / Luminaire luminous flux 500lm	
	L30106.V13.1701	2700K Ra>90 24° 220-240V AC ON-OFF	
	L30106.V15.1701	IP20	
	L30106.V14.1701		
	L30106.V04.1701		
	L30106.V09.1701		
	L30106.V10.1701		
	L30106.V16.1701		
		L30106.V17.2501	
	L30106.V08.2501	Flusso luminoso apparecchio / Luminaire luminous flux 500lm	
	L30106.V13.2501	3000K Ra>90 24° 220-240V AC ON-OFF	
	L30106.V15.2501	IP20	
	L30106.V14.2501		
	L30106.V04.2501		
	L30106.V09.2501		
	L30106.V10.2501		
	L30106.V16.2501		

Fotometrie disponibili www.panzeri.it / Photometric data available at www.panzeri.it

CODICI COLORI DISPONIBILI COLOUR CODES AVAILABLE	COLORE VETRI GLASSES COLOUR										
06 nero satinato matte black	V17 ghiaccio ice	V08 trasparente transparent	V13 rosa pink	V15 arancione orange	V14 caramello caramel	V04 ambra amber	V09 fumè smoke grey	V10 verde foresta forest green	V16 turchese turquoise		

VERSIONE PER BINARIO STREET A PAGINA 175 / STREET TRACK VERSION ON PAGE 175



SCENT PIXEL

Marc Sadler 2026



Scent Pixel evolve il concetto di illuminazione puntuale in un sistema di pura libertà creativa, trasformando la luce da singolo accento a vera struttura architettonica. Il modulo Pixel si spoglia del superfluo per farsi ritmo e geometria: un elemento discreto che permette di comporre costellazioni luminose capaci di vibrare nello spazio. L'anima preziosa ispirata ai flaconi di profumo si mostra attraverso le sfaccettature del vetro, che si moltiplicano in una narrazione creativa. È un invito a progettare non solo la luce, ma l'atmosfera stessa, lasciando che ogni installazione diventi un racconto sensoriale diffuso e profondo.

Scent Pixel evolves the concept of punctual lighting into a system of pure creative freedom, transforming light from a single accent into a true architectural structure. The Pixel module strips away the superfluous to become rhythm and geometry: a discreet element that allows for the composition of luminous constellations capable of vibrating in space. Its precious soul, inspired by perfume bottles, reveals itself through the glass facets, which multiply into a creative narrative. It is an invitation to design not just the light, but the atmosphere itself, letting every installation become a diffuse and deep sensory story.

NEW	CODICE CODE	FONTI LUM INOSE LIGHT SOURCES	kg
	L30406.V17.0501	Potenza assorbita apparecchio / Luminaire power consumption 4W	0,68
	L30406.V08.0501	Flusso luminoso apparecchio / Luminaire luminous flux 181lm	
	L30406.V13.0501	2700K Ra>90 220-240V AC ON-OFF	
	L30406.V15.0501	IP20	
	L30406.V14.0501		
	L30406.V04.0501		
	L30406.V09.0501		
	L30406.V10.0501		
	L30406.V16.0501		
		L30406.V17.0401	
L30406.V08.0401		Flusso luminoso apparecchio / Luminaire luminous flux 181lm	
L30406.V13.0401		3000K Ra>90 220-240V AC ON-OFF	
L30406.V15.0401		IP20	
L30406.V14.0401			
L30406.V04.0401			
L30406.V09.0401			
L30406.V10.0401			
L30406.V16.0401			

	M30406.V17.0501	Potenza assorbita apparecchio / Luminaire power consumption 2,8W	0,28
	M30406.V08.0501	Flusso luminoso apparecchio / Luminaire luminous flux 181lm	
	M30406.V13.0501	2700K Ra>90 220-240V AC ON-OFF	
	M30406.V15.0501	IP20	
	M30406.V14.0501		
	M30406.V04.0501		
	M30406.V09.0501		
	M30406.V10.0501		
	M30406.V16.0501		
		M30406.V17.0401	
M30406.V08.0401		Flusso luminoso apparecchio / Luminaire luminous flux 181lm	
M30406.V13.0401		3000K Ra>90 220-240V AC ON-OFF	
M30406.V15.0401		IP20	
M30406.V14.0401			
M30406.V04.0401			
M30406.V09.0401			
M30406.V10.0401			
M30406.V16.0401			

Fotometrie disponibili www.panzeri.it / Photometric data available at www.panzeri.it

CODICI COLORI DISPONIBILI COLOUR CODES AVAILABLE

COLORE VETRI GLASSES COLOUR

06 nero satinato
matte black

V17 ghiaccio
ice

V08 trasparente
transparent

V13 rosa
pink

V15 arancione
orange

V14 caramello
caramel

V04 ambra
amber

V09 fumè
smoke grey

V10 verde foresta
forest green

V16 turchese
turquoise





SCENT PIXEL CLUSTER

Marc Sadler 2026

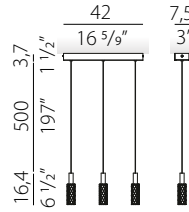

CODICE CODE	FONTI LUM INOSE LIGHT SOURCES	kg
KRL04206.V17.001	Cluster 3 elementi / 3 fixtures cluster	1,99
KRL04206.V08.001	Potenza assorbita apparecchio	
KRL04206.V13.001	Luminaire power consumption 10,5W	
KRL04206.V15.001	Flusso luminoso apparecchio	
KRL04206.V14.001	Luminaire luminous flux 3x181lm	
KRL04206.V04.001	2700K Ra>90 220-240V AC ON-OFF	
KRL04206.V09.001	IP20	
KRL04206.V10.001		
KRL04206.V16.001		

KRL04206.V17.002	Cluster 3 elementi / 3 fixtures cluster	1,99
KRL04206.V08.002	Potenza assorbita apparecchio	
KRL04206.V13.002	Luminaire power consumption 10,5W	
KRL04206.V15.002	Flusso luminoso apparecchio	
KRL04206.V14.002	Luminaire luminous flux 3x181lm	
KRL04206.V04.002	3000K Ra>90 220-240V AC ON-OFF	
KRL04206.V09.002	IP20	
KRL04206.V10.002		
KRL04206.V16.002		

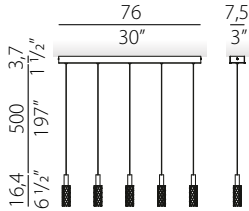

KRL07606.V17.001	Cluster 5 elementi / 5 fixtures cluster	2,99
KRL07606.V08.001	Potenza assorbita apparecchio	
KRL07606.V13.001	Luminaire power consumption 10,5W	
KRL07606.V15.001	Flusso luminoso apparecchio	
KRL07606.V14.001	Luminaire luminous flux 5x181lm	
KRL07606.V04.001	2700K Ra>90 220-240V AC ON-OFF	
KRL07606.V09.001	IP20	
KRL07606.V10.001		
KRL07606.V16.001		

KRL07606.V17.002	Cluster 5 elementi / 5 fixtures cluster	2,99
KRL07606.V08.002	Potenza assorbita apparecchio	
KRL07606.V13.002	Luminaire power consumption 10,5W	
KRL07606.V15.002	Flusso luminoso apparecchio	
KRL07606.V14.002	Luminaire luminous flux 5x181lm	
KRL07606.V04.002	3000K Ra>90 220-240V AC ON-OFF	
KRL07606.V09.002	IP20	
KRL07606.V10.002		
KRL07606.V16.002		

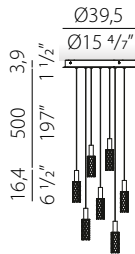



KRT03906.V17.001	Cluster 7 elementi / 7 fixtures cluster	5,17
KRT03906.V08.001	Potenza assorbita apparecchio	
KRT03906.V13.001	Luminaire power consumption 10,5W	
KRT03906.V15.001	Flusso luminoso apparecchio	
KRT03906.V14.001	Luminaire luminous flux 7x181lm	
KRT03906.V04.001	2700K Ra>90 220-240V AC ON-OFF	
KRT03906.V09.001	IP20	
KRT03906.V10.001		
KRT03906.V16.001		

KRT03906.V17.002	Cluster 7 elementi / 7 fixtures cluster	5,17
KRT03906.V08.002	Potenza assorbita apparecchio	
KRT03906.V13.002	Luminaire power consumption 10,5W	
KRT03906.V15.002	Flusso luminoso apparecchio	
KRT03906.V14.002	Luminaire luminous flux 7x181lm	
KRT03906.V04.002	3000K Ra>90 220-240V AC ON-OFF	
KRT03906.V09.002	IP20	
KRT03906.V10.002		
KRT03906.V16.002		

SCENT PIXEL CLUSTER

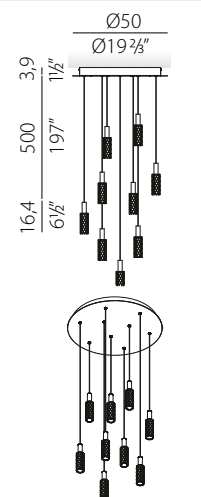
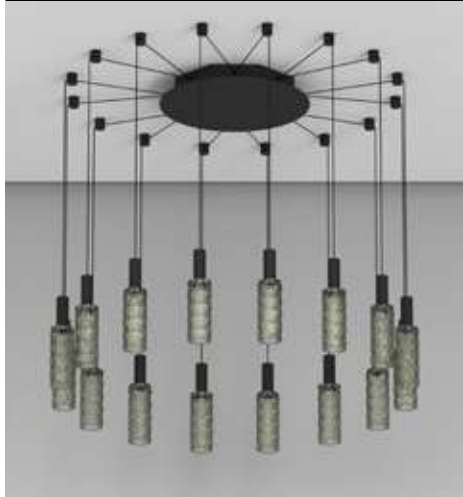
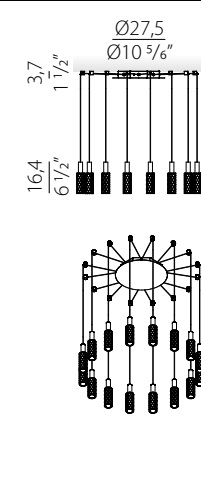
Marc Sadler 2026

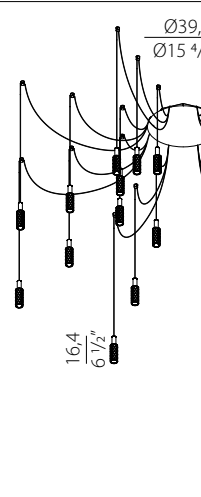
	CODICE CODE	FONTI LUM INOSE LIGHT SOURCES	kg		
 	KRT05006.V17.001 KRT05006.V08.001 KRT05006.V13.001 KRT05006.V15.001 KRT05006.V14.001 KRT05006.V04.001 KRT05006.V09.001 KRT05006.V10.001 KRT05006.V16.001	Cluster 9 elementi / 9 fixtures cluster Potenza assorbita apparecchio Luminaire power consumption 27,5W Flusso luminoso apparecchio Luminaire luminous flux 9x181lm 2700K Ra>90 220-240V AC ON-OFF LED IP20	7,96		
	KRT05006.V17.002 KRT05006.V08.002 KRT05006.V13.002 KRT05006.V15.002 KRT05006.V14.002 KRT05006.V04.002 KRT05006.V09.002 KRT05006.V10.002 KRT05006.V16.002	Cluster 9 elementi / 9 fixtures cluster Potenza assorbita apparecchio Luminaire power consumption 27,5W Flusso luminoso apparecchio Luminaire luminous flux 9x181lm 3000K Ra>90 220-240V AC ON-OFF LED IP20	7,96		
	 	KRT02706.V17.001 KRT02706.V08.001 KRT02706.V13.001 KRT02706.V15.001 KRT02706.V14.001 KRT02706.V04.001 KRT02706.V09.001 KRT02706.V10.001 KRT02706.V16.001	Cluster 16 elementi / 16 fixtures cluster Decentramenti per cavo elettrico singolo inclusi / Single electrical cable offset included Potenza assorbita apparecchio Luminaire power consumption 47W Flusso luminoso apparecchio Luminaire luminous flux 16x181lm 2700K Ra>90 220-240V AC DALI / Push DIM LED IP20	6,05	
		KRT02706.V17.002 KRT02706.V08.002 KRT02706.V13.002 KRT02706.V15.002 KRT02706.V14.002 KRT02706.V04.002 KRT02706.V09.002 KRT02706.V10.002 KRT02706.V16.002	Cluster 16 elementi / 16 fixtures cluster Decentramenti per cavo elettrico singolo inclusi / Single electrical cable offset included Potenza assorbita apparecchio Luminaire power consumption 47W Flusso luminoso apparecchio Luminaire luminous flux 16x181lm 3000K Ra>90 220-240V AC DALI / Push DIM LED IP20	6,05	
		 	KRT03906.V17.003 KRT03906.V08.003 KRT03906.V13.003 KRT03906.V15.003 KRT03906.V14.003 KRT03906.V04.003 KRT03906.V09.003 KRT03906.V10.003 KRT03906.V16.003	Cluster 24 elementi / 24 fixtures cluster Decentramenti per cavo elettrico singolo inclusi / Single electrical cable offset included Potenza assorbita apparecchio Luminaire power consumption 70W Flusso luminoso apparecchio Luminaire luminous flux 24x181lm 2700K Ra>90 220-240V AC DALI / Push DIM LED IP20	10,5
			KRT03906.V17.004 KRT03906.V08.004 KRT03906.V13.004 KRT03906.V15.004 KRT03906.V14.004 KRT03906.V04.004 KRT03906.V09.004 KRT03906.V10.004 KRT03906.V16.004	Cluster 24 elementi / 24 fixtures cluster Decentramenti per cavo elettrico singolo inclusi / Single electrical cable offset included Potenza assorbita apparecchio Luminaire power consumption 70W Flusso luminoso apparecchio Luminaire luminous flux 24x181lm 3000K Ra>90 220-240V AC DALI / Push DIM LED IP20	10,5

Fotometrie disponibili www.panzeri.it / Photometric data available at www.panzeri.it

CODICI COLORI DISPONIBILI
COLOUR CODES AVAILABLE

COLORE VETRI
GLASSES COLOUR

06 nero satinato
matte black

V17 ghiaccio
ice

V08 trasparente
transparent

V13 rosa
pink

V15 arancione
orange

V14 caramello
caramel

V04 ambr
amber

V09 fumè
smoke grey

V10 verde foresta
forest green

V16 turchese
turquoise





SMOKE

Silvia Poma 2018



Lampada a sospensione in vetro soffiato lavorato a mano con effetto sfumato. Rosone in metallo spazzolato e verniciato colore titanio. Emissione di luce diffusa con attacco E27, lampadina LED dimmerabile inclusa. Vetro soffiato disponibile in tre misure, in colore bianco sfumato, fumè sfumato e verde foresta sfumato. Cavo elettrico trasparente.

Suspension lamp in handmade blown glass in shaded effect. Metal part brushed and painted in titanium finish. Diffused light emission with E27 socket, LED bulb dimmable included. Blown glass available in three sizes, in shaded white, shaded smoky grey and shaded green forest. Transparent electric cable.

	CODICE CODE	FONTI LUMINOSE LIGHT SOURCES	kg
	L01540.027.0200	LED retrofit bulb 21W E27 2700K Ra80 2500lm (dimmable)	2,46
	L01541.027.0200	max 116W E27	
	L01543.027.0200	IP20 Sorgente luminosa LED inclusa LED bulb included	
	L01540.035.0200	LED retrofit bulb 21W E27 2700K Ra80 2500lm (dimmable)	2,90
	L01541.035.0200	max 116W E27	
	L01543.035.0200	IP20 Sorgente luminosa LED inclusa LED bulb included	
	L01540.050.0200	LED retrofit bulb 21W E27 2700K Ra80 2500lm (dimmable)	7,02
	L01541.050.0200	max 116W E27	
	L01543.050.0200	IP20 Sorgente luminosa LED inclusa LED bulb included	

Fotometrie disponibili www.panzeri.it / Photometric data available at www.panzeri.it

CODICI COLORI DISPONIBILI / COLOUR CODES AVAILABLE

40 titanio/diffusore fumé
titanium/smoky grey diffuser

41 titanio/diffusore bianco
titanium/white diffuser

43 titanio/diffusore verde foresta
titanium/forest green diffuser





SUPERBOLD

Favaretto&Partners 2025

Registered Design



La collezione Superbold prende ispirazione dalla semplicità del cerchio, un segno preciso che con le sue forme morbide e senza tempo dialoga con lo spazio in maniera discreta. L'ingombro ridotto e la luce diffusa che filtra attraverso l'anello in tecnopolimero opaco permettono di arredare ed illuminare da parete e soffitto diverse tipologie di ambienti domestici e pubblici. Superbold è disponibile in due dimensioni in finiture bianco soft materico, nero satinato, champagne, bronzo, blu mirto materico e terracotta naturale materico, che restituiscono diversi effetti sia visivi che tattili, caratterizzando lo spazio in cui sono inseriti. DALI/Push DIM disponibile a richiesta.

The Superbold collection is inspired by the simplicity of the circle, a precise sign that with its soft and timeless shapes dialogues with space in a discreet manner. The small footprint and the diffused light filtering through the opaque technopolymer ring allow it to furnish and illuminate different types of domestic and public environments from walls and ceilings. Superbold is available in two sizes in textured soft white, matte black, champagne, bronze, textured myrtle blue, and textured natural terracotta finishes, which provide different visual and tactile effects, characterising the space in which they are inserted. DALI/Push DIM available on request.

	CODICE CODE	FONTI LUMINOSE LIGHT SOURCES	kg
<p>7,8 3"</p> <p>44,3 17 4/9"</p>	P09905.045.0504	Potenza assorbita apparecchio / Luminaire power consumption 17W	2,22
	P09906.045.0504	Flusso luminoso apparecchio / Luminaire luminous flux 1414lm	
	P09917.045.0504	2700K Ra>90 220-240V AC dimmable (phase cut)	
	P09926.045.0504	IP40	
	P09928.045.0504		
<p>7,8 3"</p> <p>44,3 17 4/9"</p>	P09905.045.0404	Potenza assorbita apparecchio / Luminaire power consumption 17W	2,22
	P09906.045.0404	Flusso luminoso apparecchio / Luminaire luminous flux 1443lm	
	P09917.045.0404	3000K Ra>90 220-240V AC dimmable (phase cut)	
	P09926.045.0404	IP40	
	P09928.045.0404		
<p>9,9 4"</p> <p>62,3 24 5/9"</p>	P09905.060.0504	Potenza assorbita apparecchio / Luminaire power consumption 32W	4,17
	P09906.060.0504	Flusso luminoso apparecchio / Luminaire luminous flux 2122lm	
	P09917.060.0504	2700K Ra>90 220-240V AC dimmable (phase cut)	
	P09926.060.0504	IP40	
	P09928.060.0504		
<p>9,9 4"</p> <p>62,3 24 5/9"</p>	P09905.060.0404	Potenza assorbita apparecchio / Luminaire power consumption 32W	4,17
	P09906.060.0404	Flusso luminoso apparecchio / Luminaire luminous flux 2165lm	
	P09917.060.0404	3000K Ra>90 220-240V AC dimmable (phase cut)	
	P09926.060.0404	IP40	
	P09928.060.0404		

Fotometrie disponibili www.panzeri.it / Photometric data available at www.panzeri.it **Disponibili a richiesta con elettrificazione DALI/Push DIM / Available on request with DALI/Push DIM power supply**

CODICI COLORI DISPONIBILI / COLOUR CODES AVAILABLE

- 05** champagne champagne
- 06** nero satinato matte black
- 17** bronzo bronze
- 26** blu mirto materico textured myrtle blue
- 28** bianco soft materico textured soft white
- 29** terracotta naturale materico textured natural terracotta





Lampada LED da parete/soffitto in alluminio verniciato poliaccrilico bianco, bronzo, ottone satinato, nero e vetro satinato.

LED wall/ceiling lamp in aluminium colored in white, bronze, matte brass, black polyacrylic paint and mat glass.

	CODICE CODE	FONTI LUMINOSE LIGHT SOURCES	kg
	P03901.011.0406	Potenza assorbita apparecchio / Luminaire power consumption 10W	0,51
	P03902.011.0406	Flusso luminoso apparecchio / Luminaire luminous flux 595lm	
	P03917.011.0406	3000K Ra>90 220-240V AC ON-OFF	
	P03919.011.0406	IP40	
	P03901.015.0406	Potenza assorbita apparecchio / Luminaire power consumption 15W	1,32
	P03902.015.0406	Flusso luminoso apparecchio / Luminaire luminous flux 956lm	
	P03917.015.0406	3000K Ra>90 220-240V AC ON-OFF	
	P03919.015.0406	IP40	
	XM14/230	Dispositivo dimmerabile per moduli LED a 230V, 5÷100W. Dimmable device for 230V LED modules, 5÷100W.	

Fotometrie disponibili www.panzeri.it / Photometric data available at www.panzeri.it

CODICI COLORI DISPONIBILI / COLOUR CODES AVAILABLE

- | | | | |
|---------------------------|-------------------------|----------------------------|--|
| 01 bianco
white | 02 nero
black | 17 bronzo
bronze | 19 ottone satinato
matte brass |
|---------------------------|-------------------------|----------------------------|--|





Lampada a sospensione in alluminio estruso disponibile in \varnothing 22mm o \varnothing 32 mm e rispettive lunghezze 850mm/650mm. Lampada a sospensione e plafone in alluminio estruso con \varnothing 55 mm e lunghezza 450mm. La versione con \varnothing 55mm prevede la possibilità di installare tre ottiche con fascio 20°, 35°, 55°. Sorgente luminosa composta da modulo LED ad elevate prestazioni CRI>90 2700K. Rosone con driver ON-OFF integrato nella versione \varnothing 22mm. Driver ON-OFF integrato nel cilindro nella versione \varnothing 32mm e 55mm. Finitura con vernice poliaccrilica in bianco, nero satinato, bronzo, ottone satinato o finitura in foglia oro decorata a mano. Cavo elettrico trasparente ultrasottile. Ideale per ristoranti, zone living, camere da letto o per creare grandi composizioni a cascata.

Aluminum extruded suspension lamp in \varnothing 22mm or \varnothing 32mm diameter and respectively 850mm/650mm length. Aluminum extruded suspension and ceiling lamp in \varnothing 55mm and length 450mm. The version in \varnothing 55mm is available with three different beam angles 20°, 35°, 55°. Light sources made of highly performing LED module with CRI>90 2700K. Canopy with ON-OFF driver integrated in the \varnothing 22mm version. Integrated ON-OFF driver inside the cylinder for the versions \varnothing 32mm and 55mm. Finish in white, matte black, bronze, matte brass polyacrylic paint or hand-made decorated in golden leaf. Ultra-thin transparent electrical cable. Ideal for restaurants, living areas, bedrooms, and to create big cascading compositions.

	CODICE CODE	FONTI LUMINOSE LIGHT SOURCES	kg
	L02501.085.0501	Potenza assorbita apparecchio / Luminaire power consumption 4W	0,75
	L02506.085.0501	Flusso luminoso apparecchio / Luminaire luminous flux 181lm	
	L02517.085.0501	2700K Ra>90 220-240V AC ON-OFF	
	L02519.085.0501	IP40	
	L02501.085.0401	Potenza assorbita apparecchio / Luminaire power consumption 4W	0,75
	L02506.085.0401	Flusso luminoso apparecchio / Luminaire luminous flux 181lm	
	L02517.085.0401	3000K Ra>90 220-240V AC ON-OFF	
	L02519.085.0401	IP40	
	L02601.065.0501	Potenza assorbita apparecchio / Luminaire power consumption 7W	0,74
	L02606.065.0501	Flusso luminoso apparecchio / Luminaire luminous flux 363lm	
	L02617.065.0501	2700K Ra>90 220-240V AC ON-OFF	
	L02619.065.0501	IP40	
	L02601.065.0401	Potenza assorbita apparecchio / Luminaire power consumption 7W	0,74
	L02606.065.0401	Flusso luminoso apparecchio / Luminaire luminous flux 363lm	
	L02617.065.0401	3000K Ra>90 220-240V AC ON-OFF	
	L02621.065.0401	IP40	
	L02701.045.1701	Potenza assorbita apparecchio / Luminaire power consumption 10W	1,13
	L02706.045.1701	Flusso luminoso apparecchio / Luminaire luminous flux 806lm	
	L02717.045.1701	2700K Ra>90 35° 220-240V AC ON-OFF	
	L02719.045.1701	IP20	
	L02701.045.2501	Potenza assorbita apparecchio / Luminaire power consumption 10W	1,13
	L02706.045.2501	Flusso luminoso apparecchio / Luminaire luminous flux 806lm	
	L02717.045.2501	3000K Ra>90 35° 220-240V AC ON-OFF	
	L02721.045.2501	IP20 Per progetti a richiesta ottiche 20° e 55° Beam angles 20°, 55° on request for projects	

	CODICE CODE	FONTI LUMINOSE LIGHT SOURCES	kg	
	M02501.085.0510 M02506.085.0510 M02517.085.0510 M02519.085.0510 M02521.085.0510	Potenza assorbita apparecchio / Luminaire power consumption 2,8W Flusso luminoso apparecchio / Luminaire luminous flux 181lm 2700K Ra>90 24V DC IP40	0,64	
	M02501.085.0410 M02506.085.0410 M02517.085.0410 M02519.085.0410 M02521.085.0410	Potenza assorbita apparecchio / Luminaire power consumption 2,8W Flusso luminoso apparecchio / Luminaire luminous flux 181lm 3000K Ra>90 24V DC IP40	0,64	
	Fornito con cavo di collegamento 5m, senza rosone e driver, per composizioni multiple o in combinazione con Hilow Supplied with 5m cable, without canopy and driver, for multiple configurations or configurations with Hilow			
	M02601.065.0510 M02606.065.0510 M02617.065.0510 M02619.065.0510 M02621.065.0510			0,45
	M02601.065.0410 M02606.065.0410 M02617.065.0410 M02619.065.0410 M02621.065.0410	Potenza assorbita apparecchio / Luminaire power consumption 5,3W Flusso luminoso apparecchio / Luminaire luminous flux 363lm 3000K Ra>90 24V DC IP40	0,45	
Fornito senza rosone e driver, per composizioni multiple Supplied without canopy and driver, for multiple configurations				
	P02701.045.1701 P02706.045.1701 P02717.045.1701 P02719.045.1701 P02721.045.1701	Potenza assorbita apparecchio / Luminaire power consumption 10W Flusso luminoso apparecchio / Luminaire luminous flux 806lm 2700K Ra>90 35° 220-240V AC ON-OFF IP20	0,85	
	P02701.045.2501 P02706.045.2501 P02717.045.2501 P02719.045.2501 P02721.045.2501	Potenza assorbita apparecchio / Luminaire power consumption 10W Flusso luminoso apparecchio / Luminaire luminous flux 806lm 3000K Ra>90 35° 220-240V AC ON-OFF IP20	0,85	
	Per progetti a richiesta ottiche 20° e 55° Beam angles 20°, 55° on request for projects			

Fotometrie disponibili www.panzeri.it / Photometric data available at www.panzeri.it

CODICI COLORI DISPONIBILI / COLOUR CODES AVAILABLE

- 01** bianco
white
- 06** nero satinato
matte black
- 17** bronzo
bronze
- 19** ottone satinato
matte brass
- 21** foglia oro
gold leaf



ROSONI E DECENTRAMENTI A PAGINA 105 / OFFSET AND CANOPIES PAGE 105

VERSIONE PER BINARIO STREET A PAGINA 177 / STREET TRACK VERSION ON PAGE 177



Lampada da parete biemissione che unisce minimalismo, geometria e alte prestazioni. La geometria del corpo in alluminio estruso indirizza il flusso luminoso verso il centro della stanza. La forma semplice, scandita dalle linee curve e dalle raggiature morbide della cover esterna con accoppiamento magnetico, si adatta a varie tipologie di ambiente. Le diverse lunghezze disponibili rendono l'apparecchio adatto per installazioni singole e composizioni di più elementi, in corridoi, aree di passaggio e locali ampi. Disponibile in finitura bianca, nera, bronzo, ottone satinato e titanio. Disponibili a richiesta le finiture verde oliva materico e terracotta naturale materico. DALI/Push DIM disponibile a richiesta.

Double-emission wall lamp that combines minimalism, geometry and high performance. The geometry of the extruded body directs the luminous flux towards the centre of the room. The simple shape, defined by the curved lines and edges of the external cover with magnetic coupling, adapts to various types of environment. The different available lengths make the fixture suitable for single installations and multi-element compositions, in corridors, transit areas and large ambiances. Available in white, black, bronze, matte brass and titanium finishes. Textured olive green and textured natural terracotta finishes available on request. DALI/Push DIM available on request.

	CODICE CODE	FONTI LUMINOSE LIGHT SOURCES	kg
	A14201.015.0504	Potenza assorbita apparecchio / Luminaire power consumption 10W	0,82
	A14202.015.0504	Flusso luminoso apparecchio / Luminaire luminous flux 657lm	
	A14217.015.0504	2700K Ra>90 220-240V AC dimmable (phase cut)	
	A14219.015.0504	IP20	
	A14201.015.0404	Potenza assorbita apparecchio / Luminaire power consumption 10W	0,82
	A14202.015.0404	Flusso luminoso apparecchio / Luminaire luminous flux 657lm	
	A14217.015.0404	3000K Ra>90 220-240V AC dimmable (phase cut)	
	A14219.015.0404	IP20	
	A14201.030.0501	Potenza assorbita apparecchio / Luminaire power consumption 18W	1,17
	A14202.030.0501	Flusso luminoso apparecchio / Luminaire luminous flux 1314lm	
	A14217.030.0501	2700K Ra>90 220-240V AC ON-OFF	
	A14230.030.0501	IP20	
	A14201.030.0401	Potenza assorbita apparecchio / Luminaire power consumption 18W	1,17
	A14202.030.0401	Flusso luminoso apparecchio / Luminaire luminous flux 1314lm	
	A14217.030.0401	3000K Ra>90 220-240V AC ON-OFF	
	A14230.030.0401	IP20	
	A14201.030.0504	Potenza assorbita apparecchio / Luminaire power consumption 20W	1,17
	A14202.030.0504	Flusso luminoso apparecchio / Luminaire luminous flux 1314lm	
	A14217.030.0504	2700K Ra>90 220-240V AC dimmable (phase cut)	
	A14230.030.0504	IP20	
	A14201.030.0404	Potenza assorbita apparecchio / Luminaire power consumption 20W	1,17
	A14202.030.0404	Flusso luminoso apparecchio / Luminaire luminous flux 1314lm	
	A14217.030.0404	3000K Ra>90 220-240V AC dimmable (phase cut)	
	A14230.030.0404	IP20	

TOY R

Enzo Panzeri 2024

	CODICE CODE	FONTI LUMINOSE LIGHT SOURCES	kg
	A14201.045.0501	Potenza assorbita apparecchio / Luminaire power consumption 26W	1,67
	A14202.045.0501	Flusso luminoso apparecchio / Luminaire luminous flux 1971lm	
	A14217.045.0501	3000K Ra>90 220-240V AC ON-OFF	
	A14219.045.0501	IP20	
	A14230.045.0501		
	A14201.045.0401	Potenza assorbita apparecchio / Luminaire power consumption 26W	1,67
	A14202.045.0401	Flusso luminoso apparecchio / Luminaire luminous flux 1971lm	
	A14217.045.0401	2700K Ra>90 220-240V AC dimmable (phase cut)	
A14219.045.0401	IP20		
	A14230.045.0401		
	A14201.045.0504	Potenza assorbita apparecchio / Luminaire power consumption 26W	1,67
	A14202.045.0504	Flusso luminoso apparecchio / Luminaire luminous flux 1971lm	
	A14217.045.0504	2700K Ra>90 220-240V AC ON-OFF	
A14219.045.0504	IP20		
	A14230.045.0504		
	A14201.045.0404	Potenza assorbita apparecchio / Luminaire power consumption 26W	1,67
	A14202.045.0404	Flusso luminoso apparecchio / Luminaire luminous flux 1971lm	
	A14217.045.0404	3000K Ra>90 220-240V AC dimmable (phase cut)	
A14219.045.0404	IP20		
	A14230.045.0404		
	A14201.060.0501	Potenza assorbita apparecchio / Luminaire power consumption 34W	2,17
	A14202.060.0501	Flusso luminoso apparecchio / Luminaire luminous flux 2628lm	
	A14217.060.0501	2700K Ra>90 220-240V AC ON-OFF	
A14219.060.0501	IP20		
	A14230.060.0501		
	A14201.060.0401	Potenza assorbita apparecchio / Luminaire power consumption 34W	2,17
	A14202.060.0401	Flusso luminoso apparecchio / Luminaire luminous flux 2628lm	
	A14217.060.0401	3000K Ra>90 220-240V AC ON-OFF	
A14219.060.0401	IP20		
	A14230.060.0401		
	A14201.060.0504	Potenza assorbita apparecchio / Luminaire power consumption 34W	2,17
	A14202.060.0504	Flusso luminoso apparecchio / Luminaire luminous flux 2628lm	
	A14217.060.0504	2700K Ra>90 220-240V AC dimmable (phase cut)	
A14219.060.0504	IP20		
	A14230.060.0504		
	A14201.060.0404	Potenza assorbita apparecchio / Luminaire power consumption 34W	2,17
	A14202.060.0404	Flusso luminoso apparecchio / Luminaire luminous flux 2628lm	
	A14217.060.0404	3000K Ra>90 220-240V AC dimmable (phase cut)	
A14219.060.0404	IP20		
	A14230.060.0404		

Fotometrie disponibili www.panzeri.it / Photometric data available at www.panzeri.it

Disponibili a richiesta con elettrificazione DALI/Push DIM / Available on request with DALI/Push DIM power supply

CODICI COLORI DISPONIBILI / COLOUR CODES AVAILABLE

Disponibili a richiesta / Available on request

01 bianco white	02 nero black	17 bronzo bronze	19 ottone satinato matte brass	30 titanio titanium	27 verde oliva materico textured olive green	29 terracotta naturale materico textured natural terracotta
---------------------------	-------------------------	----------------------------	--	-------------------------------	--	---











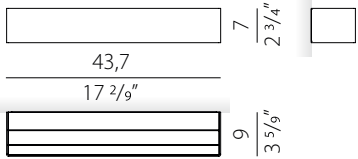

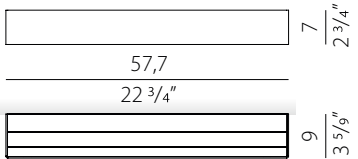

Lampada da parete biemissione che unisce minimalismo, geometria e alte prestazioni. La geometria del corpo in alluminio estruso indirizza il flusso luminoso verso il centro della stanza. La forma semplice, scandita dalle linee nette e precise e dagli spigoli definiti della cover esterna con accoppiamento magnetico, si adatta a varie tipologie di ambiente. Le diverse lunghezze disponibili rendono l'apparecchio adatto per installazioni singole e composizioni di più elementi, in corridoi, aree di passaggio e locali ampi. Disponibile in finitura bianca, nera, bronzo, ottone satinato e titanio. Disponibili a richiesta le finiture verde oliva materico e terracotta naturale materico. DALI/Push DIM disponibile a richiesta.

Double-emission wall lamp that combines minimalism, geometry and high performance. The geometry of the extruded body directs the luminous flux towards the centre of the room. The simple shape, marked by the clear, precise lines and the defined edges of the external cover with magnetic coupling, adapts to various types of environment. The different available lengths make the fixture suitable for single installations and multi-element compositions, in corridors, transit areas and large ambiances. Available in white, black, bronze, matte brass and titanium finishes. Textured olive green and textured natural terracotta finishes available on request. DALI/Push DIM available on request.

	CODICE CODE	FONTE LUMINOSE LIGHT SOURCES	kg
	A14101.015.0504	Potenza assorbita apparecchio / Luminaire power consumption 10W	0,85
	A14102.015.0504	Flusso luminoso apparecchio / Luminaire luminous flux 657lm	
	A14117.015.0504	2700K Ra>90 220-240V AC dimmable (phase cut)	
	A14119.015.0504	IP20	
	A14101.015.0404	Potenza assorbita apparecchio / Luminaire power consumption 10W	0,85
	A14102.015.0404	Flusso luminoso apparecchio / Luminaire luminous flux 657lm	
	A14117.015.0404	3000K Ra>90 220-240V AC dimmable (phase cut)	
	A14119.015.0404	IP20	
	A14101.030.0501	Potenza assorbita apparecchio / Luminaire power consumption 18W	1,20
	A14102.030.0501	Flusso luminoso apparecchio / Luminaire luminous flux 1314lm	
	A14117.030.0501	2700K Ra>90 220-240V AC ON-OFF	
	A14130.030.0501	IP20	
	A14101.030.0401	Potenza assorbita apparecchio / Luminaire power consumption 18W	1,20
	A14102.030.0401	Flusso luminoso apparecchio / Luminaire luminous flux 1314lm	
	A14117.030.0401	3000K Ra>90 220-240V AC ON-OFF	
	A14130.030.0401	IP20	
	A14101.030.0504	Potenza assorbita apparecchio / Luminaire power consumption 20W	1,20
	A14102.030.0504	Flusso luminoso apparecchio / Luminaire luminous flux 1314lm	
	A14117.030.0504	2700K Ra>90 220-240V AC dimmable (phase cut)	
	A14130.030.0504	IP20	
	A14101.030.0404	Potenza assorbita apparecchio / Luminaire power consumption 20W	1,20
	A14102.030.0404	Flusso luminoso apparecchio / Luminaire luminous flux 1314lm	
	A14117.030.0404	3000K Ra>90 220-240V AC dimmable (phase cut)	
	A14130.030.0404	IP20	

	CODICE CODE	FONTI LUMINOSE LIGHT SOURCES	kg
	A14101.045.0501	Potenza assorbita apparecchio / Luminaire power consumption 26W	1,70
	A14102.045.0501	Flusso luminoso apparecchio / Luminaire luminous flux 1971lm	
	A14117.045.0501	2700K Ra>90 220-240V AC ON-OFF	
	A14119.045.0501	 IP20	
	A14130.045.0501		
	A14101.045.0401	Potenza assorbita apparecchio / Luminaire power consumption 26W	1,70
	A14102.045.0401	Flusso luminoso apparecchio / Luminaire luminous flux 1971lm	
	A14117.045.0401	3000K Ra>90 220-240V AC ON-OFF	
A14119.045.0401	 IP20		
	A14130.045.0401		
	A14101.045.0504	Potenza assorbita apparecchio / Luminaire power consumption 26W	1,70
	A14102.045.0504	Flusso luminoso apparecchio / Luminaire luminous flux 1971lm	
	A14117.045.0504	2700K Ra>90 220-240V AC dimmable (phase cut)	
A14119.045.0504	 IP20		
	A14130.045.0504		
	A14101.045.0404	Potenza assorbita apparecchio / Luminaire power consumption 26W	1,70
	A14102.045.0404	Flusso luminoso apparecchio / Luminaire luminous flux 1971lm	
	A14117.045.0404	3000K Ra>90 220-240V AC dimmable (phase cut)	
A14119.045.0404	 IP20		
	A14130.045.0404		
	A14101.060.0501	Potenza assorbita apparecchio / Luminaire power consumption 34W	2,10
	A14102.060.0501	Flusso luminoso apparecchio / Luminaire luminous flux 2628lm	
	A14117.060.0501	2700K Ra>90 220-240V AC ON-OFF	
A14119.060.0501	 IP20		
	A14130.060.0501		
	A14101.060.0401	Potenza assorbita apparecchio / Luminaire power consumption 34W	2,10
	A14102.060.0401	Flusso luminoso apparecchio / Luminaire luminous flux 2628lm	
	A14117.060.0401	3000K Ra>90 220-240V AC ON-OFF	
A14119.060.0401	 IP20		
	A14130.060.0401		
	A14101.060.0504	Potenza assorbita apparecchio / Luminaire power consumption 34W	2,10
	A14102.060.0504	Flusso luminoso apparecchio / Luminaire luminous flux 2628lm	
	A14117.060.0504	2700K Ra>90 220-240V AC dimmable (phase cut)	
A14119.060.0504	 IP20		
	A14130.060.0504		
	A14101.060.0404	Potenza assorbita apparecchio / Luminaire power consumption 34W	2,10
	A14102.060.0404	Flusso luminoso apparecchio / Luminaire luminous flux 2628lm	
	A14117.060.0404	3000K Ra>90 220-240V AC dimmable (phase cut)	
A14119.060.0404	 IP20		
	A14130.060.0404		

Fotometrie disponibili www.panzeri.it / Photometric data available at www.panzeri.it

Disponibili a richiesta con elettrificazione DALI/Push DIM / Available on request with DALI/Push DIM power supply

CODICI COLORI DISPONIBILI / COLOUR CODES AVAILABLE

Disponibili a richiesta / Available on request

01 bianco white	02 nero black	17 bronzo bronze	19 ottone satinato matte brass	30 titanio titanium	27 verde oliva materico textured olive green	29 terracotta naturale materico textured natural terracotta
---------------------------	-------------------------	----------------------------	--	-------------------------------	--	---





TUBINO

Matteo Thun 2019/2020

Registered Design



Lampada a sospensione, tavolo, parete/soffitto (disponibile anche a incasso) e terra in alluminio tornito con accensione ON-OFF e cavo trasparente. Tubino parete/soffitto è particolarmente adatta in applicazione alla testata del letto, sia in ambito residenziale che hospitality. Nella versione terra le sorgenti raddoppiano, il posizionamento sulla struttura a stelo è pensato per consentire l'utilizzo anche come lampada da lettura. La versione tavolo è disponibile nella variante Tubino Plus con comando Step DIM a 5 regolazioni dell'intensità luminosa in finitura champagne, bronzo o titanio con cavo di alimentazione tra la testa e la struttura in tessuto colorato.

Suspension, table, wall/ceiling (also available as recessed) and floor lamp in turned aluminium with ON-OFF ignition and transparent cable. Tubino wall/ceiling can be easily applied to the bedhead, both in residential and hospitality projects. In the floor version the lighting sources double, the positioning on the stem structure is designed to allow an use also as a reading lamp. The table version is also available as Tubino Plus with Step DIM control and 5 light intensity settings. Champagne bronze and titanium finishes with fabric colored cable between the head and the structure.

	CODICE CODE	FONTI LUMINOSE LIGHT SOURCES	kg
	C07301.001.0501 C07306.001.0501	Potenza assorbita apparecchio / Luminaire power consumption 6,5W Flusso luminoso apparecchio / Luminaire luminous flux 339lm 2700K Ra>90 220-240V AC ON-OFF IP20	1,42
	C07301.001.0401 C07306.001.0401	Potenza assorbita apparecchio / Luminaire power consumption 6,5W Flusso luminoso apparecchio / Luminaire luminous flux 339lm 3000K Ra>90 220-240V AC ON-OFF IP20	1,42
	A07301.001.0501 A07305.001.0501 A07306.001.0501 A07317.001.0501 A07330.001.0501	Potenza assorbita apparecchio / Luminaire power consumption 6,5W Flusso luminoso apparecchio / Luminaire luminous flux 339lm 2700K Ra>90 220-240V AC ON-OFF IP20	0,62
	A07301.001.0401 A07305.001.0401 A07306.001.0401 A07317.001.0401 A07330.001.0401	Potenza assorbita apparecchio / Luminaire power consumption 6,5W Flusso luminoso apparecchio / Luminaire luminous flux 339lm 3000K Ra>90 220-240V AC ON-OFF IP20	0,62
	X07301.001.0501 X07305.001.0501 X07306.001.0501 X07317.001.0501 X07330.001.0501	Potenza assorbita apparecchio / Luminaire power consumption 6,5W Flusso luminoso apparecchio / Luminaire luminous flux 339lm 2700K Ra>90 220-240V AC ON-OFF IP20	1,09
	X07301.001.0401 X07305.001.0401 X07306.001.0401 X07317.001.0401 X07330.001.0401	Potenza assorbita apparecchio / Luminaire power consumption 6,5W Flusso luminoso apparecchio / Luminaire luminous flux 339lm 3000K Ra>90 220-240V AC ON-OFF IP20	1,09
	L07301.001.0501 L07305.001.0501 L07306.001.0501 L07317.001.0501 L07330.001.0501	Potenza assorbita apparecchio / Luminaire power consumption 6,5W Flusso luminoso apparecchio / Luminaire luminous flux 339lm 2700K Ra>90 220-240V AC ON-OFF IP20	0,51
	L07301.001.0401 L07305.001.0401 L07306.001.0401 L07317.001.0401 L07330.001.0401	Potenza assorbita apparecchio / Luminaire power consumption 6,5W Flusso luminoso apparecchio / Luminaire luminous flux 339lm 3000K Ra>90 220-240V AC ON-OFF IP20	0,51

TUBINO

Matteo Thun 2019/2020

Registered Design

	CODICE CODE	FONTE LUMINOSE LIGHT SOURCES	kg
	T073Q1.002.0501	Potenza assorbita apparecchio / Luminaire power consumption 13W	4,49
	T073Q6.002.0501	Flusso luminoso apparecchio / Luminaire luminous flux 678lm 2700K Ra>90 220-240V AC ON-OFF	
		IP20	Cavo trasparente Transparent cable
	T073Q1.002.0401	Potenza assorbita apparecchio / Luminaire power consumption 13W	4,49
T073Q6.002.0401	Flusso luminoso apparecchio / Luminaire luminous flux 678lm 3000K Ra>90 220-240V AC ON-OFF		
		IP20	Cavo trasparente Transparent cable

Fotometrie disponibili www.panzeri.it / Photometric data available at www.panzeri.it

CODICI COLORI DISPONIBILI / COLOUR CODES AVAILABLE

01 bianco white **05** champagne champagne **06** nero satinato matte black **17** bronzo bronze **30** titanio titanium





TUBINO

Matteo Thun 2019

Registered Design



Lampada da tavolo in alluminio tornito. Tubino Plus è disponibile in versione con comando Step DIM a 5 regolazioni di intensità luminosa in finitura champagne, bronzo e titanio con cavo di alimentazione tra la testa e la struttura in tessuto.

Aluminium table in turned aluminium. Tubino Plus is available with Step DIM control with 5 light intensity settings in champagne, bronze and titanium finish with fabric cable between the head and the structure.

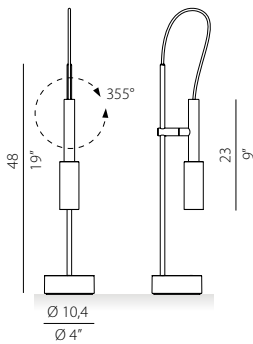

CODICE CODE	FONTI LUMINOSE LIGHT SOURCES	kg
C07305.001.0509	Potenza assorbita apparecchio / Luminaire power consumption 6,5W	1,42
C07317.001.0509	Flusso luminoso apparecchio / Luminaire luminous flux 339lm	
C07330.001.0509	2700K Ra>90 220-240V AC dimmable (Step DIM)	
	IP20	
	Finitura champagne con cavo in tessuto color champagne, bronzo con cavo in tessuto bourdeaux, titanio con cavo in tessuto verde. Interruttore incluso Champagne with champagne fabric cable, bronze with bourdeaux fabric cable. Titanium with green fabric cable. Switch included	
C07305.001.0409	Potenza assorbita apparecchio / Luminaire power consumption 6,5W	1,42
C07317.001.0409	Flusso luminoso apparecchio / Luminaire luminous flux 339lm	
C07330.001.0409	3000K Ra>90 220-240V AC dimmable (Step DIM)	
	IP20	
	Finitura champagne con cavo in tessuto color champagne, bronzo con cavo in tessuto bourdeaux, titanio con cavo in tessuto verde. Interruttore incluso Champagne with champagne fabric cable, bronze with bourdeaux fabric cable. Titanium with green fabric cable. Switch included	



Fotometrie disponibili www.panzeri.it / Photometric data available at www.panzeri.it

CODICI COLORI DISPONIBILI / COLOUR CODES AVAILABLE

05 champagne champagne	17 bronzo bronze	30 titanio titanium
----------------------------------	----------------------------	-------------------------------



Lampada a parete costituita da una barra in ottone. Luce indiretta emessa attraverso schermo in policarbonato semiopale. Fonte luminosa costituita da modulo LED. Struttura rifinita con vernice poliaccrilica in colore bianco, nero, bronzo, ottone satinato o cromata. Due versioni disponibili: montatura incassata nel muro o montatura esterna. Nessun elemento di fissaggio a vista. Ideale per ambienti residenziali o moderne strutture hospitality.

Wall lamp in brass bar. Indirect light emitted through a semi-opal polycarbonate screen. LED module. Fitting in white, black, bronze, matte brass polyacrylic paint or in chrome version. Two available versions: recessed mounting in the wall or external mounting. No visible fastening element. Ideal for residential spaces or modern hospitality facilities.

	CODICE CODE	FONTI LUMINOSE LIGHT SOURCES	kg
	A07201.000.0401	Potenza assorbita apparecchio / Luminaire power consumption 13W	0,59
	A07202.000.0401	Flusso luminoso apparecchio / Luminaire luminous flux 1046lm	
	A07217.000.0401	3000K Ra>90 220-240V AC ON-OFF	
	A07219.000.0401	IP20	
	A07222.000.0401		

	X07201.000.0401	Potenza assorbita apparecchio / Luminaire power consumption 13W	0,59
	X07202.000.0401	Flusso luminoso apparecchio / Luminaire luminous flux 1046lm	
	X07217.000.0401	3000K Ra>90 220-240V AC ON-OFF	
	X07219.000.0401	IP20	
	X07222.000.0401		

Fotometrie disponibili www.panzeri.it / Photometric data available at www.panzeri.it

CODICI COLORI DISPONIBILI / COLOUR CODES AVAILABLE

01 bianco white **02** nero black **17** bronzo bronze **19** ottone satinato matte brass **22** cromo chrome





ZERO LINE

Enzo Panzeri 2024

Lampade da parete/soffitto in metallo bianco, nero, cromo, bronzo, ottone satinato e foglia oro, con riflettore coordinato, complete di LED e driver.

Wall and ceiling lamps in white, black, chrome, bronze, matte brass and gold leaf, with matching reflector, complete with LED and driver.

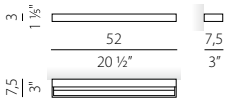

CODICE CODE	FONTI LUMINOSE LIGHT SOURCES	kg
A03601.050.0501	Potenza assorbita apparecchio / Luminaire power consumption 12,2W	0,92
A03602.050.0501	Flusso luminoso apparecchio / Luminaire luminous flux 640lm	
A03617.050.0501	2700K Ra>90 220-240V AC ON-OFF	
A03619.050.0501	IP20	
A03621.050.0501	Riflettore satinato / Satin reflector	
A03622.050.0501	Potenza assorbita apparecchio / Luminaire power consumption 12,2W	0,92
	Flusso luminoso apparecchio / Luminaire luminous flux 786lm	
	2700K Ra>90 220-240V AC ON-OFF	
	IP20	
	Riflettore cromato / Chrome reflector	
A03601.100.0501	Potenza assorbita apparecchio / Luminaire power consumption 22,2W	1,58
A03602.100.0501	Flusso luminoso apparecchio / Luminaire luminous flux 1280lm	
A03617.100.0501	2700K Ra>90 220-240V AC ON-OFF	
A03619.100.0501	IP20	
A03621.100.0501	Riflettore satinato / Satin reflector	
A03622.100.0501	Potenza assorbita apparecchio / Luminaire power consumption 22,2W	1,58
	Flusso luminoso apparecchio / Luminaire luminous flux 1572lm	
	2700K Ra>90 220-240V AC ON-OFF	
	IP20	
	Riflettore cromato / Chrome reflector	
A03601.100.0502	Potenza assorbita apparecchio / Luminaire power consumption 22,2W	1,58
A03602.100.0502	Flusso luminoso apparecchio / Luminaire luminous flux 1280lm	
A03617.100.0502	2700K Ra>90 220-240V AC dimmable (DALI/Push DIM)	
A03619.100.0502	IP20	
A03621.100.0502	Riflettore satinato / Satin reflector	
A03622.100.0502	Potenza assorbita apparecchio / Luminaire power consumption 22,2W	1,58
	Flusso luminoso apparecchio / Luminaire luminous flux 1572lm	
	2700K Ra>90 220-240V AC dimmable (DALI/Push DIM)	
	IP20	
	Riflettore cromato / Chrome reflector	

Fotometrie disponibili www.panzeri.it / Photometric data available at www.panzeri.it

Disponibili a richiesta LED 3000K / On request 3000K LED available

CODICI COLORI DISPONIBILI / COLOUR CODES AVAILABLE

01 bianco
white

02 nero
black

17 bronzo
bronze

19 ottone satinato
matte brass

21 foglia oro
gold leaf

22 cromo
chrome





ZERO SHAPES

Enzo Panzeri 2022



Lampada a sospensione orizzontale in alluminio estruso curvato, con schermo in policarbonato opale. Emissione interna attraverso modulo LED e tecnologia ZigBee di serie su tutte le versioni inserita nel rosone. Anello rifinito con vernice poliacrilica color bianco, nero, champagne, titanio, bronzo e ottone satinato. Ideale per ambienti residenziali e zone living.

Horizontal suspension lamp in extruded curved aluminum, with opal polycarbonate screen. Emission on the internal side provided by LED modules with ZigBee technology integrated into the canopy. Polyacrylic paint white, black, champagne, titanium, bronze and matte brass finishes are available. Ideal for residential spaces and living areas.

	CODICE CODE	FONTI LUMINOSE LIGHT SOURCES	kg
	L15301.050.0523	Potenza assorbita apparecchio / Luminaire power consumption 25W	1,91
	L15302.050.0523	Flusso luminoso apparecchio / Luminaire luminous flux 2039lm	
	L15305.050.0523	2700K Ra>90 220-240V AC dimmable (ZigBee)	
	L15317.050.0523	IP20	
	L15319.050.0523	Fornito con rosone e driver Supplied with canopy and driver	
	L15301.050.0423	Potenza assorbita apparecchio / Luminaire power consumption 25W	1,91
	L15302.050.0423	Flusso luminoso apparecchio / Luminaire luminous flux 2039lm	
	L15305.050.0423	3000K Ra>90 220-240V AC dimmable (ZigBee)	
	L15317.050.0423	IP20	
	L15319.050.0423	Fornito con rosone e driver Supplied with canopy and driver	
	L15301.075.0523	Potenza assorbita apparecchio / Luminaire power consumption 36W	2,15
	L15302.075.0523	Flusso luminoso apparecchio / Luminaire luminous flux 3059lm	
	L15305.075.0523	2700K Ra>90 220-240V AC dimmable (ZigBee)	
	L15317.075.0523	IP20	
	L15319.075.0523	Fornito con rosone e driver Supplied with canopy and driver	
	L15301.075.0423	Potenza assorbita apparecchio / Luminaire power consumption 36W	2,15
	L15302.075.0423	Flusso luminoso apparecchio / Luminaire luminous flux 3059lm	
	L15305.075.0423	3000K Ra>90 220-240V AC dimmable (ZigBee)	
	L15317.075.0423	IP20	
	L15319.075.0423	Fornito con rosone e driver Supplied with canopy and driver	
	L15301.100.0523	Potenza assorbita apparecchio / Luminaire power consumption 47W	2,32
	L15302.100.0523	Flusso luminoso apparecchio / Luminaire luminous flux 4079lm	
	L15305.100.0523	2700K Ra>90 220-240V AC dimmable (ZigBee)	
	L15317.100.0523	IP20	
	L15319.100.0523	Fornito con rosone e driver Supplied with canopy and driver	
	L15301.100.0423	Potenza assorbita apparecchio / Luminaire power consumption 47W	2,32
	L15302.100.0423	Flusso luminoso apparecchio / Luminaire luminous flux 4079lm	
	L15305.100.0423	3000K Ra>90 220-240V AC dimmable (ZigBee)	
	L15317.100.0423	IP20	
	L15319.100.0423	Fornito con rosone e driver Supplied with canopy and driver	

	YCO.T001	Telecomando per dispositivi wireless ZigBee, per accensione/spengimento e regolazione di 4 gruppi di massimo 30 corpi illuminanti. Remote controller for ZigBee wireless devices, supporting switch and dimming control of 4 groups with up to 30 lighting fixtures maximum.	0,07
--	-----------------	---	------

Fotometrie disponibili www.panzeri.it / Photometric data available at www.panzeri.it

CODICI COLORI DISPONIBILI / COLOUR CODES AVAILABLE

01 bianco white	02 nero black	05 champagne champagne	17 bronzo bronze	19 ottone satinato matte brass	30 titanio titanium
---------------------------	-------------------------	----------------------------------	----------------------------	--	-------------------------------



ZERO SHAPES

Enzo Panzeri 2018



Lampada a sospensione orizzontale, a parete e a soffitto in alluminio estruso curvato, con schermo in policarbonato opale. Emissione interna attraverso modulo LED e tecnologia DALI/Push DIM di serie su tutte le versioni inserita nel rosone. Anello rifinito con vernice poliaccrilica color bianco, nero, champagne, titanio, bronzo e ottone satinato. Disponibilità di rosone per installazioni singole e per composizioni multiple da ordinare separatamente. Ideale per uffici, hall, zone living, grandi spazi, anche in abbinamento con Zero Round Acoustic e Arena Acoustic.

Horizontal suspension lamp, wall and ceiling lamp in extruded curved aluminum, with opal polycarbonate screen. Emission on the internal side provided by LED modules with technology DALI/Push DIM integrated into the canopy. Polyacrilic paint white, black, champagne, titanium, bronze and matte brass finishes are available. Canopies for single and multiple configurations with Zero Ellipse and Zero Square are available, to be ordered separately. Ideal for offices, halls, living, and public spaces, also combined with Zero Round Acoustic and Arena Acoustic.

	CODICE CODE	FONTE LUMINOSA LIGHT SOURCES	kg
	P15301.050.0502 P15302.050.0502 P15305.050.0502 P15317.050.0502 P15319.050.0502 P15330.050.0502	Potenza assorbita apparecchio / Luminaire power consumption 29W Flusso luminoso apparecchio / Luminaire luminous flux 2039lm 2700K Ra>90 220-240V AC dimmable (DALI/Push DIM)	1,41
	P15301.050.0402 P15302.050.0402 P15305.050.0402 P15317.050.0402 P15319.050.0402 P15330.050.0402	Potenza assorbita apparecchio / Luminaire power consumption 29W Flusso luminoso apparecchio / Luminaire luminous flux 2039lm 3000K Ra>90 220-240V AC dimmable (DALI/Push DIM)	1,41
	P15301.075.0502 P15302.075.0502 P15305.075.0502 P15317.075.0502 P15319.075.0502 P15330.075.0502	Potenza assorbita apparecchio / Luminaire power consumption 42W Flusso luminoso apparecchio / Luminaire luminous flux 3059lm 2700K Ra>90 220-240V AC dimmable (DALI/Push DIM)	1,80
	P15301.075.0402 P15302.075.0402 P15305.075.0402 P15317.075.0402 P15319.075.0402 P15330.075.0402	Potenza assorbita apparecchio / Luminaire power consumption 42W Flusso luminoso apparecchio / Luminaire luminous flux 3059lm 3000K Ra>90 220-240V AC dimmable (DALI/Push DIM)	1,80
	P15301.100.0502 P15302.100.0502 P15305.100.0502 P15317.100.0502 P15319.100.0502 P15330.100.0502	Potenza assorbita apparecchio / Luminaire power consumption 54W Flusso luminoso apparecchio / Luminaire luminous flux 4079lm 2700K Ra>90 220-240V AC dimmable (DALI/Push DIM)	2,06
	P15301.100.0402 P15302.100.0402 P15305.100.0402 P15317.100.0402 P15319.100.0402 P15330.100.0402	Potenza assorbita apparecchio / Luminaire power consumption 54W Flusso luminoso apparecchio / Luminaire luminous flux 4079lm 3000K Ra>90 220-240V AC dimmable (DALI/Push DIM)	2,06
	A15301.025.0501 A15302.025.0501 A15305.025.0501 A15317.025.0501 A15319.025.0501 A15330.025.0501	Potenza assorbita apparecchio / Luminaire power consumption 13W Flusso luminoso apparecchio / Luminaire luminous flux 796lm 2700K Ra>90 220-240V AC ON-OFF	0,62
	A15301.025.0401 A15302.025.0401 A15305.025.0401 A15317.025.0401 A15319.025.0401 A15330.025.0401	Potenza assorbita apparecchio / Luminaire power consumption 13W Flusso luminoso apparecchio / Luminaire luminous flux 796lm 3000K Ra>90 220-240V AC ON-OFF	0,62
	A15301.025.0501 A15302.025.0501 A15305.025.0501 A15317.025.0501 A15319.025.0501 A15330.025.0501	Potenza assorbita apparecchio / Luminaire power consumption 13W Flusso luminoso apparecchio / Luminaire luminous flux 796lm 2700K Ra>90 220-240V AC ON-OFF	0,62
	A15301.025.0401 A15302.025.0401 A15305.025.0401 A15317.025.0401 A15319.025.0401 A15330.025.0401	Potenza assorbita apparecchio / Luminaire power consumption 13W Flusso luminoso apparecchio / Luminaire luminous flux 796lm 3000K Ra>90 220-240V AC ON-OFF	0,62

ZERO SHAPES

Enzo Panzeri 2018

	CODICE CODE	FONTI LUMINOSE LIGHT SOURCES	kg
	M15501.125.0510 M15502.125.0510 M15505.125.0510 M15517.125.0510 M15519.125.0510 M15530.125.0510	Potenza assorbita apparecchio / Luminaire power consumption 62W Flusso luminoso apparecchio / Luminaire luminous flux 5099lm 2700K Ra>90 24V DC LED IP20	1,50
	M15501.125.0410 M15502.125.0410 M15505.125.0410 M15517.125.0410 M15519.125.0410 M15530.125.0410	Potenza assorbita apparecchio / Luminaire power consumption 62W Flusso luminoso apparecchio / Luminaire luminous flux 5099lm 3000K Ra>90 24V DC LED IP20	1,50
	M15501.150.0510 M15502.150.0510 M15505.150.0510 M15517.150.0510 M15519.150.0510 M15530.150.0510	Potenza assorbita apparecchio / Luminaire power consumption 71W Flusso luminoso apparecchio / Luminaire luminous flux 6120lm 2700K Ra>90 24V DC LED IP20	1,58
	M15501.150.0410 M15502.150.0410 M15505.150.0410 M15517.150.0410 M15519.150.0410 M15530.150.0410	Potenza assorbita apparecchio / Luminaire power consumption 71W Flusso luminoso apparecchio / Luminaire luminous flux 6120lm 3000K Ra>90 24V DC LED IP20	1,58
	M15501.200.0510 M15502.200.0510 M15505.200.0510 M15517.200.0510 M15519.200.0510 M15530.200.0510	Potenza assorbita apparecchio / Luminaire power consumption 88W Flusso luminoso apparecchio / Luminaire luminous flux 8158lm 2700K Ra>90 24V DC LED IP20	2,34
	M15501.200.0410 M15502.200.0410 M15505.200.0410 M15517.200.0410 M15519.200.0410 M15530.200.0410	Potenza assorbita apparecchio / Luminaire power consumption 88W Flusso luminoso apparecchio / Luminaire luminous flux 8158lm 3000K Ra>90 24V DC LED IP20	2,34
	XM15501.521.0002 XM15502.521.0002 XM15505.521.0002 XM15517.521.0002 XM15519.521.0002 XM15530.521.0002	Rosone per alimentazione di 1 modello Zero Round 125 - Zero Round 150 - Zero Round 200, con driver 100W DALI/Push DIM. Canopy for power supply of 1 Zero Round 125 - Zero Round 150 - Zero Round 200 model, with 100W DALI/Push DIM driver.	2,56

ZERO SHAPES

Enzo Panzeri 2018

	CODICE CODE	FONTI LUMINOSE LIGHT SOURCES	kg
	M15301.050.0510	Potenza assorbita apparecchio / Luminaire power consumption 25W	0,83
	M15302.050.0510	Flusso luminoso apparecchio / Luminaire luminous flux 2039lm	
	M15305.050.0510	2700K Ra>90 24V DC	
	M15317.050.0510	IP20	
	M15319.050.0510	Elemento singolo per composizioni; fornito senza rosone e driver.	
M15330.050.0510	Accessorio per appendimento del cavo elettrico incluso. Single element for configurations; without canopy and driver. Accessory for electrical cable hanging included.		
	M15301.050.0410	Potenza assorbita apparecchio / Luminaire power consumption 25W	0,83
	M15302.050.0410	Flusso luminoso apparecchio / Luminaire luminous flux 2039lm	
	M15305.050.0410	3000K Ra>90 24V DC	
	M15317.050.0410	IP20	
	M15319.050.0410	Elemento singolo per composizioni; fornito senza rosone e driver.	
M15330.050.0410	Accessorio per appendimento del cavo elettrico incluso. Single element for configurations; without canopy and driver. Accessory for electrical cable hanging included.		
	M15301.075.0510	Potenza assorbita apparecchio / Luminaire power consumption 36W	1,12
	M15302.075.0510	Flusso luminoso apparecchio / Luminaire luminous flux 3059lm	
	M15305.075.0510	2700K Ra>90 24V DC	
	M15317.075.0510	IP20	
	M15319.075.0510	Elemento singolo per composizioni; fornito senza rosone e driver.	
M15330.075.0510	Accessorio per appendimento del cavo elettrico incluso. Single element for configurations; without canopy and driver. Accessory for electrical cable hanging included.		
	M15301.075.0410	Potenza assorbita apparecchio / Luminaire power consumption 36W	1,12
	M15302.075.0410	Flusso luminoso apparecchio / Luminaire luminous flux 3059lm	
	M15305.075.0410	3000K Ra>90 24V DC	
	M15317.075.0410	IP20	
	M15319.075.0410	Elemento singolo per composizioni; fornito senza rosone e driver.	
M15330.075.0410	Accessorio per appendimento del cavo elettrico incluso. Single element for configurations; without canopy and driver. Accessory for electrical cable hanging included.		
	M15301.100.0510	Potenza assorbita apparecchio / Luminaire power consumption 47W	1,43
	M15302.100.0510	Flusso luminoso apparecchio / Luminaire luminous flux 4079lm	
	M15305.100.0510	2700K Ra>90 24V DC	
	M15317.100.0510	IP20	
	M15319.100.0510	Elemento singolo per composizioni; fornito senza rosone e driver.	
M15330.100.0510	Accessorio per appendimento del cavo elettrico incluso. Single element for configurations; without canopy and driver. Accessory for electrical cable hanging included.		
	M15301.100.0410	Potenza assorbita apparecchio / Luminaire power consumption 47W	1,43
	M15302.100.0410	Flusso luminoso apparecchio / Luminaire luminous flux 4079lm	
	M15305.100.0410	3000K Ra>90 24V DC	
	M15317.100.0410	IP20	
	M15319.100.0410	Elemento singolo per composizioni; fornito senza rosone e driver.	
M15330.100.0410	Accessorio per appendimento del cavo elettrico incluso. Single element for configurations; without canopy and driver. Accessory for electrical cable hanging included.		

Fotometrie disponibili www.panzeri.it / Photometric data available at www.panzeri.it

CODICI COLORI DISPONIBILI / COLOUR CODES AVAILABLE



ROSONI PER ZERO SHAPES A PAGINA 103 / CANOPIES FOR ZERO SHAPES ON PAGE 103



ZERO SHAPES

Enzo Panzeri 2018



Lampada a sospensione verticale in alluminio estruso curvato con schermo in policarbonato opale. Emissione interna attraverso modulo LED e tecnologia DALI/Push DIM di serie su tutte le versioni inserita nel rosone. Anello rifinito con vernice poliaccrilica color bianco, nero, champagne, titanio, bronzo e ottone satinato. Possibili colori custom su richiesta. Disponibilità di rosone per installazioni singole e rosone per composizioni multiple da ordinare separatamente. Ideale per uffici, hall, zone living, grandi spazi, anche in abbinamento con Zero Round Acoustic e Arena Acoustic.

Vertical suspension lamp in extruded curved aluminum with opal polycarbonate screen. Emission of internal light through LED module and DALI/Push DIM technology on all the versions in the canopy. Polyacrylic white, black, champagne, titanium, bronze or matte brass painted. Canopy for single installations and canopies for multiple configurations are available, to be ordered separately. Ideal for offices, halls, living areas, large spaces, also combined with Zero Round Acoustic and Arena Acoustic.

	CODICE CODE	FONTI LUMINOSE LIGHT SOURCES	kg
 <p>500 197"</p> <p>Ø 50 Ø 19 3/8"</p>	 M15401.050.0510	Potenza assorbita apparecchio / Luminaire power consumption 25W	0,81
	 M15402.050.0510	Flusso luminoso apparecchio / Luminaire luminous flux 2039lm	
	M15405.050.0510	2700K Ra>90 24V DC	
	 M15417.050.0510	IP20 	
	M15419.050.0510	Elemento singolo per composizioni; fornito senza rosone e driver.	
M15430.050.0510	Accessorio per appendimento del cavo elettrico incluso. Single element for configurations; without canopy and driver. Accessory for electrical cable hanging included.		
 <p>500 197"</p> <p>Ø 50 Ø 19 3/8"</p>	 M15401.050.0410	Potenza assorbita apparecchio / Luminaire power consumption 25W	0,81
	 M15402.050.0410	Flusso luminoso apparecchio / Luminaire luminous flux 2039lm	
	M15405.050.0410	3000K Ra>90 24V DC	
	 M15417.050.0410	IP20 	
	M15419.050.0410	Elemento singolo per composizioni; fornito senza rosone e driver.	
M15430.050.0410	Accessorio per appendimento del cavo elettrico incluso. Single element for configurations; without canopy and driver. Accessory for electrical cable hanging included.		
 <p>500 197"</p> <p>Ø 74 Ø 29 1/8"</p>	 M15401.075.0510	Potenza assorbita apparecchio / Luminaire power consumption 36W	1,09
	 M15402.075.0510	Flusso luminoso apparecchio / Luminaire luminous flux 3059lm	
	M15405.075.0510	2700K Ra>90 24V DC	
	 M15417.075.0510	IP20 	
	M15419.075.0510	Elemento singolo per composizioni; fornito senza rosone e driver.	
M15430.075.0510	Accessorio per appendimento del cavo elettrico incluso. Single element for configurations; without canopy and driver. Accessory for electrical cable hanging included.		
 <p>500 197"</p> <p>Ø 74 Ø 29 1/8"</p>	 M15401.075.0410	Potenza assorbita apparecchio / Luminaire power consumption 36W	1,09
	 M15402.075.0410	Flusso luminoso apparecchio / Luminaire luminous flux 3059lm	
	M15405.075.0410	3000K Ra>90 24V DC	
	 M15417.075.0410	IP20 	
	M15419.075.0410	Elemento singolo per composizioni; fornito senza rosone e driver.	
M15430.075.0410	Accessorio per appendimento del cavo elettrico incluso. Single element for configurations; without canopy and driver. Accessory for electrical cable hanging included.		
 <p>500 197"</p> <p>Ø 98 Ø 38 3/8"</p>	 M15401.100.0510	Potenza assorbita apparecchio / Luminaire power consumption 47W	1,39
	 M15402.100.0510	Flusso luminoso apparecchio / Luminaire luminous flux 4079lm	
	M15405.100.0510	2700K Ra>90 24V DC	
	 M15417.100.0510	IP20 	
	M15419.100.0510	Elemento singolo per composizioni; fornito senza rosone e driver.	
M15430.100.0510	Accessorio per appendimento del cavo elettrico incluso. Single element for configurations; without canopy and driver. Accessory for electrical cable hanging included.		
 <p>500 197"</p> <p>Ø 98 Ø 38 3/8"</p>	 M15401.100.0410	Potenza assorbita apparecchio / Luminaire power consumption 47W	1,39
	 M15402.100.0410	Flusso luminoso apparecchio / Luminaire luminous flux 4079lm	
	M15405.100.0410	3000K Ra>90 24V DC	
	 M15417.100.0410	IP20 	
	M15419.100.0410	Elemento singolo per composizioni; fornito senza rosone e driver.	
M15430.100.0410	Accessorio per appendimento del cavo elettrico incluso. Single element for configurations; without canopy and driver. Accessory for electrical cable hanging included.		

ZERO SHAPES

Enzo Panzeri 2018

	CODICE CODE	FONTI LUMINOSE LIGHT SOURCES	kg
	XM15401.531.0002	Rosone per alimentazione e sospensione di 1 modello Zero Round Vertical, con driver 60W/24V DALI/Push DIM. Canopy for power supply and suspension of 1 Zero Round Vertical models, with n.1 60W/24V DALI/Push DIM drivers.	1,05
	XM15402.531.0002		
	XM15405.531.0002		
	XM15417.531.0002		
	XM15419.531.0002		
	XM15401.533.0002	Rosone per alimentazione e sospensione di 3 modelli Zero Round Vertical, con n.3 driver 60W/24V DALI/Push DIM. Canopy for power supply and suspension of 3 Zero Round Vertical models, with n.3 60W/24V DALI/Push DIM drivers.	4,26
	XM15402.533.0002		
	XM15405.533.0002		
	XM15417.533.0002		
	XM15419.533.0002		
XM15430.533.0002			

Fotometrie disponibili www.panzeri.it / Photometric data available at www.panzeri.it

CODICI COLORI DISPONIBILI / COLOUR CODES AVAILABLE

01 bianco white	02 nero black	05 champagne champagne	17 bronzo bronze	19 ottone satinato matte brass	30 titanio titanium
---------------------------	-------------------------	----------------------------------	----------------------------	--	-------------------------------





ZERO SHAPES

Enzo Panzeri 2019

Registered Design



Lampada a sospensione in alluminio estruso curvato con schermo in policarbonato opale. Emissione interna attraverso modulo LED e tecnologia DALI/Push DIM di serie su tutte le versioni inserita nel rosone. Anello rifinito con vernice poliaccrilica color bianco, nero, champagne, titanio, bronzo e ottone satinato. Possibili colori custom su richiesta. Disponibilità di rosoni per installazioni singole e composizioni multiple in abbinamento a Zero Round e Zero Square da ordinare separatamente. Ideale per uffici, hall, zone living, grandi spazi, anche con Zero Round Acoustic e Arena Acoustic.

Suspension lamp in extruded curved aluminium with opal polycarbonate screen. Emission on the internal side provided by LED modules with technology DALI/Push DIM integrated into the canopy. Polyacrilic paint white, black, champagne, titanium, bronze and matte brass finishes are available. Custom colors are available on request. Canopies for single and multiple configurations with Zero Round and Zero Square are available, to be ordered separately. Ideal for offices, halls, living, and public spaces, also combined with Zero Round Acoustic and Arena Acoustic.

	CODICE CODE	FONTI LUMINOSE LIGHT SOURCES	kg
	M15101.130.0510	Potenza assorbita apparecchio / Luminaire power consumption 47W	1,53
	M15102.130.0510	Flusso luminoso apparecchio / Luminaire luminous flux 4079lm	
	M15105.130.0510	2700K Ra>90 24V DC	
	M15117.130.0510	IP20	
	M15119.130.0510	Elemento singolo per composizioni; fornito senza rosone e driver.	
	M15130.130.0510	Accessorio per appendimento del cavo elettrico incluso. Single element for configurations; without canopy and driver. Accessory for electrical cable hanging included.	
	M15101.130.0410	Potenza assorbita apparecchio / Luminaire power consumption 47W	1,53
	M15102.130.0410	Flusso luminoso apparecchio / Luminaire luminous flux 4079lm	
	M15105.130.0410	3000K Ra>90 24V DC	
	M15117.130.0410	IP20	
	M15119.130.0410	Elemento singolo per composizioni; fornito senza rosone e driver.	
	M15130.130.0410	Accessorio per appendimento del cavo elettrico incluso. Single element for configurations; without canopy and driver. Accessory for electrical cable hanging included.	

Fotometrie disponibili www.panzeri.it / Photometric data available at www.panzeri.it

CODICI COLORI DISPONIBILI / COLOUR CODES AVAILABLE

01 bianco white **02** nero black **05** champagne champagne **17** bronzo bronze **19** ottone satinato matte brass **30** titanio titanium



ROSONI PER ZERO SHAPES A PAGINA 103 / CANOPIES FOR ZERO SHAPES ON PAGE 103



ZERO SHAPES

Enzo Panzeri 2019

Registered Design



Lampada a sospensione in alluminio estruso curvato con schermo in policarbonato opale. Emissione interna attraverso modulo LED e tecnologia DALI/Push DIM di serie su tutte le versioni inserita nel rosone. Anello rifinito con vernice poliaccrilica color bianco, nero, champagne, titanio, bronzo e ottone satinato. Possibili colori custom su richiesta. Disponibilità di rosone per installazioni singole e composizioni multiple in abbinamento a Zero Ellipse e Zero Round da ordinare separatamente. Ideale per uffici, hall, zone living, grandi spazi, anche in abbinamento con Zero Round Acoustic e Arena Acoustic.

Suspension lamp in extruded curved aluminium with opal polycarbonate screen. Emission on the internal side provided by LED modules with technology DALI/Push DIM integrated into the canopy. Polyacrylic paint white, black, champagne, titanium, bronze and matte brass finishes are available. Custom colors are available on request. Canopies for single and multiple configurations with Zero Ellipse and Zero Round are available, to be ordered separately. Ideal for offices, halls, living, and public spaces, also combined with Zero Round Acoustic and Arena Acoustic.

	CODICE CODE	FONTI LUMINOSE LIGHT SOURCES	kg
	M15201.050.0510	Potenza assorbita apparecchio / Luminaire power consumption 25W	0,92
	M15202.050.0510	Flusso luminoso apparecchio / Luminaire luminous flux 2039lm	
	M15205.050.0510	2700K Ra>90 24V DC	
	M15217.050.0510	IP20	
	M15219.050.0510	Elemento singolo per composizioni; fornito senza rosone e driver.	
M15230.050.0510	Accessorio per appendimento del cavo elettrico incluso. Single element for configurations; without canopy and driver. Accessory for electrical cable hanging included.		
	M15201.050.0410	Potenza assorbita apparecchio / Luminaire power consumption 25W	0,92
	M15202.050.0410	Flusso luminoso apparecchio / Luminaire luminous flux 2039lm	
	M15205.050.0410	3000K Ra>90 24V DC	
	M15217.050.0410	IP20	
	M15219.050.0410	Elemento singolo per composizioni; fornito senza rosone e driver.	
M15230.050.0410	Accessorio per appendimento del cavo elettrico incluso. Single element for configurations; without canopy and driver. Accessory for electrical cable hanging included.		
	M15201.075.0510	Potenza assorbita apparecchio / Luminaire power consumption 36W	1,21
	M15202.075.0510	Flusso luminoso apparecchio / Luminaire luminous flux 3059lm	
	M15205.075.0510	2700K Ra>90 24V DC	
	M15217.075.0510	IP20	
	M15219.075.0510	Elemento singolo per composizioni; fornito senza rosone e driver.	
M15230.075.0510	Accessorio per appendimento del cavo elettrico incluso. Single element for configurations; without canopy and driver. Accessory for electrical cable hanging included.		
	M15201.075.0410	Potenza assorbita apparecchio / Luminaire power consumption 36W	1,21
	M15202.075.0410	Flusso luminoso apparecchio / Luminaire luminous flux 3059lm	
	M15205.075.0410	3000K Ra>90 24V DC	
	M15217.075.0410	IP20	
	M15219.075.0410	Elemento singolo per composizioni; fornito senza rosone e driver.	
M15230.075.0410	Accessorio per appendimento del cavo elettrico incluso. Single element for configurations; without canopy and driver. Accessory for electrical cable hanging included.		

Fotometrie disponibili www.panzeri.it / Photometric data available at www.panzeri.it

CODICI COLORI DISPONIBILI / COLOUR CODES AVAILABLE

01 bianco white	02 nero black	05 champagne champagne	17 bronzo bronze	19 ottone satinato matte brass	30 titanio titanium
------------------------	----------------------	-------------------------------	-------------------------	---------------------------------------	----------------------------



ROSONI PER ZERO SHAPES A PAGINA 103 / CANOPIES FOR ZERO SHAPES ON PAGE 103

OFFSET AND CANOPIES

- 108 CANOPIES FOR MULTIPLE FIXING
- 105 OFFSET CANOPIES
- 106 OFFSET CANOPIES ACCESSORIES
- 107 RECESSED CANOPIES
- 103 ZERO SHAPES CANOPIES

ROSONI ZERO SHAPES / ZERO SHAPES CANOPIES

Officina Panzeri 2024



Un'ampia selezione di rosoni con alimentatore integrato predisposta per la sospensione degli apparecchi della famiglia Zero Shapes. Disponibili in varie misure e finiture, permettono di sostenere e alimentare singoli elementi, oppure creative composizioni multiple. Altre versioni disponibili a richiesta.

A wide selection of canopies with integrated power supply arranged for the suspension of the Zero Shapes family's fixtures. Available in various sizes and finishes, they allow the hanging and feeding of single elements or creative multiple compositions. Other versions available on request.

			CODICE CODE	DESCRIZIONE DESCRIPTION	kg
			XM15301.511.0002 XM15302.511.0002 XM15305.511.0002 XM15317.511.0002 XM15319.511.0002 XM15330.511.0002	Rosone per alimentazione e sospensione di 1 modello Zero Shapes Horizontal, con driver. Driver 60W / 24V DALI/Push DIM Canopy for power supply and suspension of 1 Zero Shapes Horizontal model, with driver. Driver 60W / 24V DALI/Push DIM	0,7
			XM15301.531.0002 XM15302.531.0002 XM15305.531.0002 XM15317.531.0002 XM15319.531.0002 XM15330.531.0002	Rosone per alimentazione e sospensione di 1 modello Zero Shapes Horizontal, con driver. Driver 60W / 24V DALI/Push DIM Canopy for power supply and suspension of 1 Zero Shapes Horizontal model, with driver. Driver 60W / 24V DALI/Push DIM	0,7
			XM15301.522.0002 XM15302.522.0002 XM15305.522.0002 XM15317.522.0002 XM15319.522.0002 XM15330.522.0002	Rosone per alimentazione di 2 modelli Zero Shapes, con n.2 driver. 2 x driver 60W / 24V DALI/Push DIM Canopy for power supply of 2 Zero Shapes models, with n.2 drivers. 2 x driver 60W / 24V DALI/Push DIM	2,93
			XM15301.532.0002 XM15302.532.0002 XM15305.532.0002 XM15317.532.0002 XM15319.532.0002 XM15330.532.0002	Rosone per alimentazione e sospensione di 2 modelli Zero Shapes Horizontal, con n.2 driver. 2 x driver 60W / 24V DALI/Push DIM Canopy for power supply and suspension of 2 Zero Shapes Horizontal models, with n.2 drivers. 2 x driver 60W / 24V DALI/Push DIM	3,04

CODICI COLORI DISPONIBILI / COLOUR CODES AVAILABLE

01 bianco
white

02 nero
black

05 champagne
champagne







17 bronzo
bronze

19 ottone satinato
matte brass

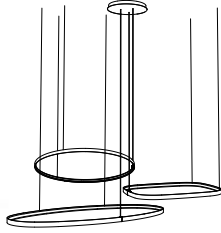
30 titanio
titanium

ROSONI ZERO SHAPES / ZERO SHAPES CANOPIES

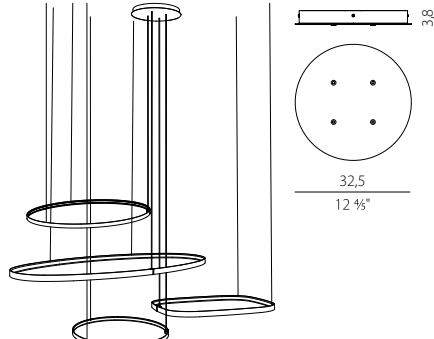
Officina Panzeri 2024

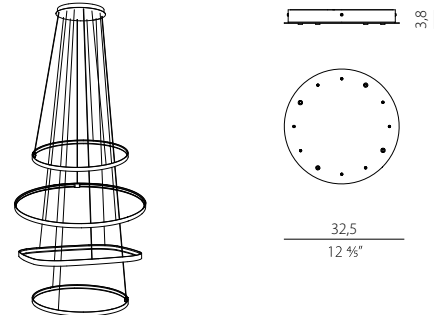
			CODICE CODE	DESCRIZIONE DESCRIPTION	kg
			XM15301.523.0002 XM15302.523.0002 XM15305.523.0002 XM15317.523.0002 XM15319.523.0002 XM15330.523.0002	Rosone per alimentazione di 3 modelli Zero Shapes, con n.3 driver. 3x driver 60W / 24V DALI/Push DIM Canopy for power supply of 3 Zero Shapes models, with n.3 drivers. 3x driver 60W / 24V DALI/Push DIM	3,02
			XM15301.533.0002 XM15302.533.0002 XM15305.533.0002 XM15317.533.0002 XM15319.533.0002 XM15330.533.0002	Rosone per alimentazione e sospensione di 3 modelli Zero Shapes Horizontal, con n.3 driver. 3x driver 60W / 24V DALI/Push DIM Canopy for power supply and suspension of 3 Zero Shapes Horizontal models, with n.3 drivers. 3x driver 60W / 24V DALI/Push DIM	3,29
			XM15301.524.0002 XM15302.524.0002 XM15305.524.0002 XM15317.524.0002 XM15319.524.0002 XM15330.524.0002	Rosone per alimentazione di 4 modelli Zero Shapes, con n.4 driver. 4x driver 60W / 24V DALI/Push DIM Canopy for power supply of 4 Zero Shapes models, with n.4 drivers. 4x driver 60W / 24V DALI/Push DIM	3,11
			XM15301.534.0002 XM15302.534.0002 XM15305.534.0002 XM15317.534.0002 XM15319.534.0002 XM15330.534.0002	Rosone per alimentazione e sospensione di 4 modelli Zero Shapes Horizontal, con n.4 driver. 4x driver 60W / 24V DALI/Push DIM Canopy for power supply and suspension of 4 Zero Shapes Horizontal models, with n.4 drivers. 4x driver 60W / 24V DALI/Push DIM	3,56

Altre versioni disponibili a richiesta / Other versions available on request.

CODICI COLORI DISPONIBILI / COLOUR CODES AVAILABLE

01 bianco
white

02 nero
black

05 champagne
champagne

17 bronzo
bronze

19 ottone satinato
matte brass

30 titanio
titanium



Rosoni tondi di dimensioni ridotte, senza viti a vista, predisposti per accogliere 1, 2 o 3 apparecchi a sospensione alimentati a tensione di rete. Disponibili a corredo decentramenti per cavi di sospensione e di alimentazione che permettono di sospendere gli apparecchi in posizioni decentrate rispetto al punto luce.

Small round canopies, without visible screws, designed to accommodate 1, 2 or 3 mains-voltage suspension fixtures. Offsets for suspension and power supply cables are available to hang the luminaires off-centre from the lighting point.

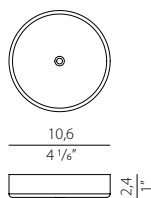

CODICE CODE	DESCRIZIONE DESCRIPTION	kg
RT01001.0001.000	Rosone per collegamento elettrico di n.1 apparecchio. Utilizzabile con apparecchi 24V prevedendo driver remoto.	0,03
RT01002.0001.000		
RT01017.0001.000		
RT01019.0001.000	Canopy for electrical connection of no.1 fixture. Suitable for 24V fixtures: remote driver 24V needed.	

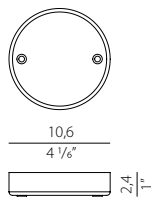

RT01001.0002.000	Rosone per collegamento elettrico di n.2 apparecchi. Utilizzabile con apparecchi 24V prevedendo driver remoto.	0,03
RT01002.0002.000		
RT01017.0002.000		
RT01019.0002.000	Canopy for electrical connection of no.2 fixtures. Suitable for 24V fixtures: remote driver 24V needed.	

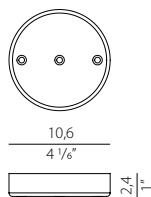

RT01001.0003.000	Rosone per collegamento elettrico di n.3 apparecchi. Utilizzabile con apparecchi 24V prevedendo driver remoto.	0,03
RT01002.0003.000		
RT01017.0003.000		
RT01019.0003.000	Suitable for 24V fixtures: remote driver 24V needed. Canopy for electrical connection of no.3 fixtures.	

CODICI COLORI DISPONIBILI / COLOUR CODES AVAILABLE

01 bianco white **02** nero black **17** bronzo bronze **19** ottone satinato matte brass

ACCESSORI PER DECENTRAMENTI / OFFSET CANOPIES ACCESSORIES



Elementi per il fissaggio di funi di sospensione e cavi di alimentazione per creare composizioni di apparecchi personalizzate.

Elements for fixing suspension ropes and power cables to create customized luminaires configurations.

M79D
M79D.02
M79D.05
M79D.17
M79D.19
M79D.30

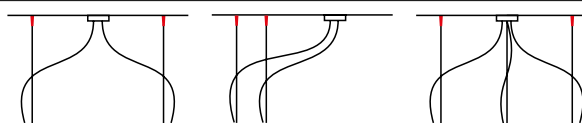

M75D
M75D.02

M800

YFD01.81A
YFD02.81A
YFD06.81A
YFD17.81A
YFD19.81A
YFD30.81A

YFD01.82A
YFD06.82A

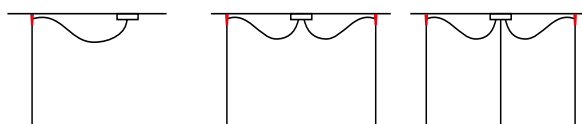

CODICE CODE	DESCRIZIONE DESCRIPTION	kg
-------------	-------------------------	----

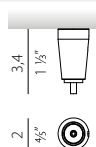

M79D
M79D.02
M79D.05
M79D.17
M79D.19
M79D.30

Dispositivo di sospensione e regolazione per fune in acciaio. 0,03

Suspension and adjustment device for steel cable.

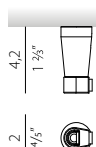

M75D
M75D.02

Dispositivo di sospensione e regolazione per cavo elettrico diam. 6mm. Possibilità di utilizzare più cavi di sezione minore. 0,03

Suspension and adjustment device for 6 mm diameter electrical cables. Possibility of using several cables of smaller dimensions.

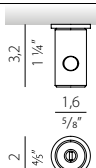

M800

Dispositivo di sospensione e regolazione in policarbonato per cavo elettrico diam. 6mm. Possibilità di utilizzare più cavi di sezione minore. 0,01

Polycarbonate suspension and adjustment device for 6mm diameter electrical cables. Possibility of using several cables of smaller dimensions.

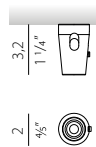

YFD01.81A
YFD02.81A
YFD06.81A
YFD17.81A
YFD19.81A
YFD30.81A

Dispositivo di sospensione e regolazione per cavo elettrico diam. 4mm. 0,03

Suspension and adjustment device for 4 mm electric cable.

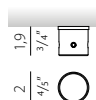

YFD01.82A
YFD06.82A

Dispositivo di sospensione e regolazione per cavo elettrico diam. 4mm. 0,02

Suspension and adjustment device for 4mm diameter electrical cables.

CODICI COLORI DISPONIBILI / COLOUR CODES AVAILABLE

01 bianco
white

02 nero
black

05 champagne
champagne

06 nero satinato
matte black

17 bronzo
bronze

19 ottone satinato
matte brass

30 titanio
titanium

ROSONI A SCOMPARSA / RECESSED CANOPIES

Officina Panzeri 2024



Rosoni piccoli e minimali installabili ad incasso nei controsoffitti, predisposti per accogliere il cavo di alimentazione di apparecchi a sospensione.

Small, minimalist ceiling canopies for recessed installation in false ceilings, designed to carry the feeding cable of suspension fixtures.

Apparecchi compatibili 220-240V / Supported fixtures 220-240V



Apparecchi compatibili 24V / Supported fixtures 24V

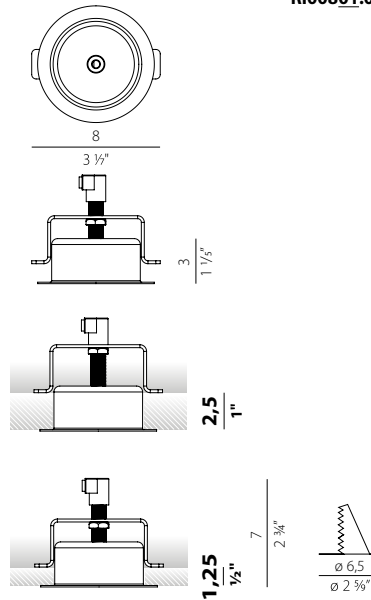

**CODICE
CODE**

RI00801.0001.000

**DESCRIZIONE
DESCRIPTION**

Rosone a scomparsa per sospensioni con solo cavo elettrico, utilizzabile per tutti gli apparecchi a 24V prevedendo driver remoto.

Recessed canopy for electric cable suspensions. Suitable for 24V fixtures: remote driver 24V needed.

kg

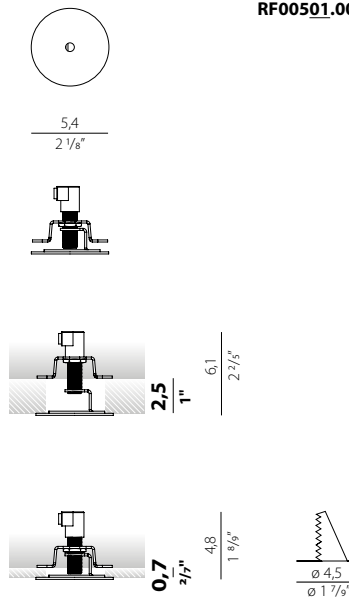

**CODICE
CODE**

RF00501.0001.000

Rosone a filo per sospensioni con solo cavo elettrico, utilizzabile per tutti gli apparecchi a 24V prevedendo driver remoto.

Flush canopy for electric cable suspensions. Suitable for 24V fixtures: remote driver 24V needed.

0,10

CODICI COLORI DISPONIBILI / COLOUR CODES AVAILABLE

01 bianco
white

ROSONI PER FISSAGGI MULTIPLI / CANOPIES FOR MULTIPLE FIXING



Un'ampia selezione di rosoni con alimentatore integrato predisposta per la sospensione degli apparecchi della famiglia Zero Shapes. Disponibili in varie misure e finiture, permettono di sostenere e alimentare singoli elementi, oppure creative composizioni multiple.

A wide selection of canopies with integrated power supply arranged for the suspension of the Zero Shapes family's fixtures. Available in various sizes and finishes, they allow the hanging and feeding of single elements or creative multiple compositions.

Apparecchi compatibili 220-240V / Supported fixtures 220-240V



Apparecchi compatibili 24V / Supported fixtures 24V

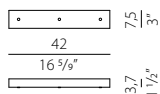

CODICE CODE	DESCRIZIONE DESCRIPTION	kg
RL04201.0003.000	Rosone lineare per collegamento elettrico con 3 uscite.	0,95
RL04205.0003.000	Linear canopy for power supply with 3 outputs.	
RL04206.0003.000		
RL04217.0003.000		
RL04219.0003.000		

RL04201.0003.A01	Rosone lineare per alimentazione e sospensione di massimo 3 modelli a tensione costante 24V DC. Driver 30W/24V on/off.	1,17
RL04202.0003.A01		
RL04205.0003.A01		
RL04206.0003.A01		
RL04217.0003.A01	Linear canopy for supply and suspension up to 3 24V DC constant voltage fixtures maximum. Driver 30W/24V on/off.	
RL04219.0003.A01		

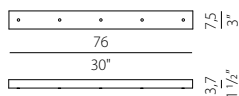

RL07601.0005.000	Rosone lineare per collegamento elettrico con 5 uscite.	1,58
RL07602.0005.000		
RL07605.0005.000	Linear canopy for power supply with 5 outputs.	
RL07606.0005.000		
RL07617.0005.000		
RL07619.0005.000		

RL07601.0005.A01	Rosone lineare per alimentazione e sospensione di massimo 5 modelli a tensione costante 24V DC. Driver 30W/24V on/off.	1,78
RL07602.0005.A01		
RL07605.0005.A01		
RL07606.0005.A01		
RL07617.0005.A01	Linear canopy for supply and suspension up to 5 24V DC constant voltage fixtures maximum. Driver 30W/24V on/off.	
RL07619.0005.A01		

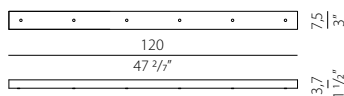





RL12001.0006.000	Rosone lineare per collegamento elettrico con 6 uscite.	2,37
RL12002.0006.000		
RL12005.0006.000	Linear canopy for power supply with 6 outputs.	
RL12006.0006.000		
RL12017.0006.000		
RL12019.0006.000		

RL12001.0006.B01	Rosone lineare per alimentazione e sospensione di massimo 6 modelli a tensione costante 24V DC. Driver 75W/24V on/off.	2,71
RL12002.0006.B01		
RL12005.0006.B01		
RL12006.0006.B01		
RL12017.0006.B01	Linear canopy for supply and suspension up to 6 24V DC constant voltage fixtures maximum. Driver 75W/24V on/off.	
RL12019.0006.B01		

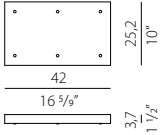
CODICI COLORI DISPONIBILI / COLOUR CODES AVAILABLE

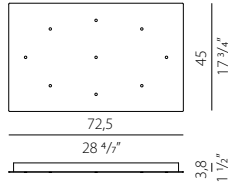
01 bianco white	02 nero black	05 champagne champagne	06 nero satinato matte black	17 bronzo bronze	19 ottone satinato matte brass
---------------------------	-------------------------	----------------------------------	--	----------------------------	--

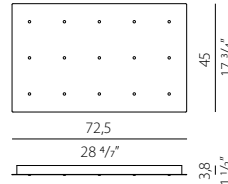
		CODICE CODE	DESCRIZIONE DESCRIPTION	kg
		RR04201.0006.000	Rosone rettangolare per collegamento elettrico con 6 uscite.	1,78
		RR04202.0006.000		
		RR04205.0006.000	Rectangular canopy for power supply with 6 outputs.	
		RR04217.0006.000		
		RR04219.0006.000		
		RR07201.0009.000	Rosone rettangolare per collegamento elettrico con 9 uscite.	6,01
			Rectangular canopy for power supply with 9 outputs.	
		RR07201.0015.000	Rosone rettangolare per collegamento elettrico con 15 uscite.	5,75
			Rectangular canopy for power supply with 15 outputs.	

CODICI COLORI DISPONIBILI / COLOUR CODES AVAILABLE

01 bianco
white









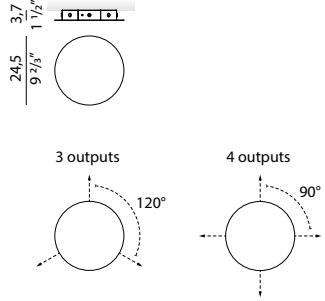

02 nero
black

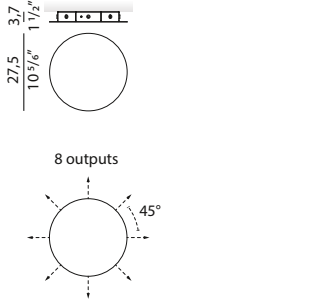
05 champagne
champagne

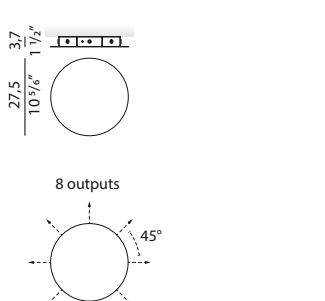
06 nero satinato
matte black

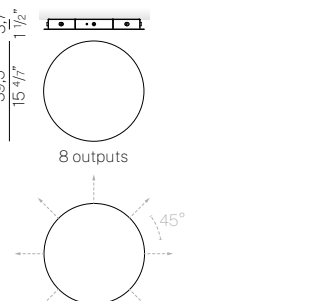

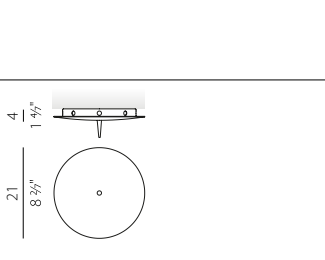
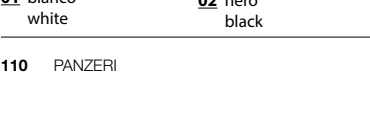



17 bronzo
bronce

19 ottone satinato
matte brass

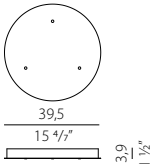
		CODICE CODE	DESCRIZIONE DESCRIPTION	kg	
		RT02401.0004.A01	Rosone tondo per alimentazione con 3/4 uscite laterali, per apparecchi a tensione costante	1,30	163,00
		RT02402.0004.A01	24V DC. Driver 12W/24V on/off. Accessorio per appendimento del cavo elettrico non incluso.		163,00
		RT02405.0004.A01	Round power supply canopy with 3/4 side outlets, for 24V DC constant voltage fixtures. Driver 12W/24V on/off. Accessory for electrical cable hanging not included.		212,00
		RT02406.0004.A01			196,00
		RT02417.0004.A01			196,00
		RT02401.0004.A02	Rosone tondo per alimentazione con 3/4 uscite laterali, per apparecchi a tensione costante	1,30	173,50
		RT02402.0004.A02	24V DC. Driver 25W/24V DALI/Push DIM. Accessorio per appendimento del cavo elettrico non incluso.		173,50
		RT02405.0004.A02	Round power supply canopy with 3/4 side outlets, for 24V DC constant voltage fixtures. Driver 25W/24V DALI/ Push DIM. Accessory for electrical cable hanging not included.		208,00
		RT02406.0004.A02			173,50
		RT02417.0004.A02			225,50
		RT02701.0008.A02	Rosone tondo per alimentazione con 8 uscite laterali, per apparecchi a tensione costante	1,60	183,50
		RT02702.0008.A02	24V DC. Driver 30W/24V DALI/Push DIM. Accessorio per appendimento del cavo elettrico non incluso.		183,50
		RT02705.0008.A02	Round power supply canopy with 8 side outlets, for 24V DC constant voltage fixtures. Driver 30W/24V DALI/ Push DIM. Accessory for electrical cable hanging not included.		
		RT02706.0008.A02			
		RT02717.0008.A02			
		RT02701.0008.B02	Rosone tondo per alimentazione con 8 uscite laterali, per apparecchi a tensione costante	1,65	
		RT02702.0008.B02	24V DC. Driver 60W/24V DALI/ Push DIM. Accessorio per appendimento del cavo elettrico non incluso.		
		RT02705.0008.B02	Round power supply canopy with 8 side outlets, for 24V DC constant voltage fixtures. Driver 60W/24V DALI/Push DIM. Accessory for electrical cable hanging not included.		
		RT02706.0008.B02			
		RT02717.0008.B02			
		RT03901.0008.A02	Rosone tondo per alimentazione con 8 uscite laterali, per apparecchi a tensione costante	3,30	
		RT03902.0008.A02	24V DC. Driver 100W/24V DALI/ Push DIM. Accessorio per appendimento del cavo elettrico non incluso.		
		RT03905.0008.A02	Round power supply canopy with 8 side outlets, for 24V DC constant voltage fixtures. Driver 100W/24V DALI/Push DIM. Accessory for electrical cable hanging not included.		
		RT03906.0008.A02			
		RT03917.0008.A02			
		RT03901.0008.B02	Rosone tondo per alimentazione con 8 uscite laterali, per apparecchi a tensione costante	3,60	
		RT03902.0008.B02	24V DC. Driver 2x100W/24V DALI/ Push DIM. Accessorio per appendimento del cavo elettrico non incluso.		
		RT03905.0008.B02	Round power supply canopy with 8 side outlets, for 24V DC constant voltage fixtures. Driver 2x100W/24V DALI/Push DIM. Accessory for electrical cable hanging not included.		
		RT03906.0008.B02			
		RT03917.0008.B02			
		M91/94/9702	Rosone per collegamento elettrico di massimo 9 apparecchi a tensione di rete 220/240V. Accessorio per appendimento del cavo elettrico non incluso.	0,50	
		M91/94/9719	Canopy for power supply up to 9 fixtures with 220/240V mains voltage. Accessory for electrical cable hanging not included.		

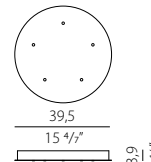

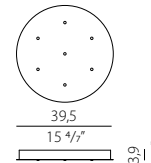

CODICI COLORI DISPONIBILI / COLOUR CODES AVAILABLE

- | | | | | | |
|---------------------------|-------------------------|----------------------------------|--|----------------------------|--|
| 01 bianco
white | 02 nero
black | 05 champagne
champagne | 06 nero satinato
matte black | 17 bronzo
bronze | 19 ottone satinato
matte brass |
|---------------------------|-------------------------|----------------------------------|--|----------------------------|--|

		CODICE CODE	DESCRIZIONE DESCRIPTION	kg
		RT03901.0003.000	Rosone tondo per collegamento elettrico con 3 uscite.	3,00
		RT03902.0003.000		
		RT03905.0003.000	Round canopy for power supply with 3 outputs.	
		RT03906.0003.000		
		RT03917.0003.000		
		RT03901.0003.A01	Rosone tondo per alimentazione e sospensione di massimo 3 modelli a tensione costante 24V DC. Driver 30W/24V on/off.	3,25
		RT03902.0003.A01		
		RT03905.0003.A01		
		RT03906.0003.A01	Round canopy for supply and suspension up to 3 24V DC constant voltage fixtures maximum. Driver 30W/24V on/off.	
		RT03917.0003.A01		
		RT03901.0005.000	Rosone tondo per collegamento elettrico con 5 uscite.	3,00
		RT03902.0005.000		
		RT03905.0005.000	Round canopy for power supply with 5 outputs.	
		RT03906.0005.000		
		RT03917.0005.000		
		RT03901.0005.A01	Rosone tondo per alimentazione e sospensione di massimo 5 modelli a tensione costante 24V DC. Driver 30W/24V on/off.	3,25
		RT03902.0005.A01		
		RT03905.0005.A01		
		RT03906.0005.A01	Round canopy for supply and suspension up to 5 24V DC constant voltage fixtures maximum. Driver 30W/24V on/off.	
		RT03917.0005.A01		
		RT03901.0007.000	Rosone tondo per collegamento elettrico con 7 uscite.	3,00
		RT03902.0007.000		
		RT03905.0007.000	Round canopy for power supply with 7 outputs.	
		RT03906.0007.000		
		RT03917.0007.000		
		RT03901.0007.B01	Rosone per alimentazione e sospensione di massimo 7 modelli a tensione costante 24V DC. Driver 75W/24V on/off.	3,25
		RT03902.0007.B01		
		RT03905.0007.B01		
		RT03906.0007.B01	Canopy for supply and suspension up to 7 24V DC constant voltage fixtures maximum. Driver 75W/24V on/off.	
		RT03917.0007.B01		

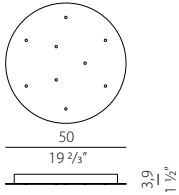
CODICI COLORI DISPONIBILI / COLOUR CODES AVAILABLE

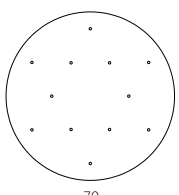
- 01** bianco white
02 nero black
05 champagne champagne
06 nero satinato matte black
17 bronzo bronze
19 ottone satinato matte brass

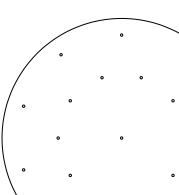
		CODICE CODE	DESCRIZIONE DESCRIPTION	kg
		RT05001.0009.000	Rosone tondo per collegamento elettrico con 9 uscite.	5,17
		RT05002.0009.000		
		RT05006.0009.000	Round canopy for power supply with 9 outputs.	
		RT05017.0009.000		
		RT05019.0009.000		
		RT07001.0012.000	Rosone tondo per collegamento elettrico con 12 uscite.	7,11
			Round canopy for power supply with 12 outputs.	
		RT10101.0021.000	Rosone tondo per collegamento elettrico con 21 uscite.	14,6
			Round canopy for power supply with 21 outputs.	

CODICI COLORI DISPONIBILI / COLOUR CODES AVAILABLE

01 bianco white	02 nero black	05 champagne champagne	06 nero satinato matte black	17 bronzo bronze	19 ottone satinato matte brass
---------------------------	-------------------------	----------------------------------	--	----------------------------	--

ACUSTICA / ACOUSTIC

114 ARENA ACOUSTIC

115 ZERO ROUND ACOUSTIC



ARENA ACOUSTIC

Enzo Panzeri 2021



Sospensione fonoassorbente per illuminazione diretta, con driver integrato per regolazione dell'intensità luminosa tramite dispositivi DALI o Push DIM.

Pannello fonoassorbente in PET, in grado di ridurre il suono riverberato (NRC 0,85). La superficie fonoassorbente è inserita nello stesso profilo in alluminio di Arena, prestandosi ad originali composizioni di elementi acustici e lampade a sospensione delle famiglie Zero Shapes e Arena. Bianco, nero, bronzo, ottone satinato e titanio le finiture disponibili. Pannello in PET colore charcoal, colori custom a richiesta.

Sound-absorbing suspension for direct lighting, with integrated driver for light intensity adjustment via DALI or Push DIM devices.

Sound-absorbing PET panel, capable of reducing reverberated sound (NRC 0.85). The sound-absorbing surface is inserted into the same aluminium profile as Arena, lending itself to original compositions of acoustic elements and suspension lamps from the Zero Shapes and Arena families. Finishes available in white, black, bronze, matte brass and titanium. Charcoal-coloured PET panel, custom colours available on request.

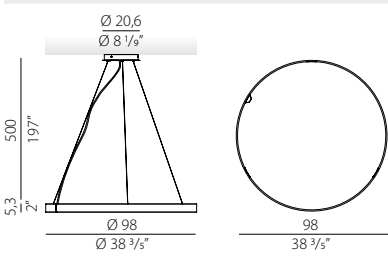

CODICE CODE	FONTI LUMINOSE LIGHT SOURCES	kg
L04601.100.0502	Potenza assorbita apparecchio / Luminaire power consumption 51W	5,80
L04602.100.0502	Flusso luminoso apparecchio / Luminaire luminous flux 1434lm	
L04617.100.0502	2700K Ra>90 220-240V AC dimmable (DALI/Push DIM)	
L04619.100.0502	IP20	
L04630.100.0502		

Fotometrie disponibili www.panzeri.it / Photometric data available at www.panzeri.it

UGR<19 in funzione delle condizioni di installazione / UGR<19 depending on installation conditions

CODICI COLORI DISPONIBILI / COLOUR CODES AVAILABLE

- | | | | | |
|---------------------------|-------------------------|----------------------------|--|-------------------------------|
| 01 bianco
white | 02 nero
black | 17 bronzo
bronze | 19 ottone satinato
matte brass | 30 titanio
titanium |
|---------------------------|-------------------------|----------------------------|--|-------------------------------|





ZERO ROUND ACOUSTIC

Enzo Panzeri 2020



Sospensione fonoassorbente con pannello in PET, in grado di ridurre il suono riverberato (NRC 0,85). La superficie fonoassorbente è inserita nello stesso profilo in alluminio di Zero Round, prestandosi ad originali composizioni di elementi acustici e lampade a sospensione delle famiglie Zero Shapes e Arena. Bianco, nero, bronzo, ottone satinato e titanio le finiture disponibili. Pannello in PET colore charcoal, colori custom a richiesta.

Sound-absorbing suspension with PET panel, capable of reducing reverberated sound (NRC 0.85). The soundabsorbing surface is inserted into the same aluminium profile as Zero Round, lending itself to original compositions of acoustic elements and suspension lamps from the Zero Shapes and Arena families. Finishes available in white, black, bronze, matte brass and titanium. Charcoal-coloured PET panel, custom colours available on request.

CODICE CODE	kg
-------------	----

- L04501.100.0099**
- L04502.100.0099**
- L04517.100.0099**
- L04519.100.0099**
- L04530.100.0099**

3,33

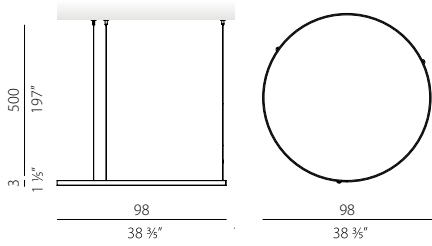

CODICI COLORI DISPONIBILI / COLOUR CODES AVAILABLE

01 bianco
white

02 nero
black

17 bronzo
bronze

19 ottone satinato
matte brass

30 titanio
titanium

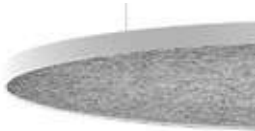

ESTERNO / OUTDOOR

- 117 DIP
- 118 FIREFLY in the sky
- 120 RALPH
- 122 ROMA
- 123 VENEXIA



DIP











Hangar Design Group

Registered Design



Con le sue versioni sospensione, parete, soffitto e terra indoor/outdoor, Dip porta la luce dove è necessario, valorizzando con classe ed eleganza ambienti residenziali e commerciali. Il design minimale degli apparecchi viene enfatizzato da un'accurata selezione di finiture specifiche per ogni tipologia di installazione che nella versione terra indoor, lavorano in abbinamento alla base in marmo nero marquina o travertino. Versione da sospensione con cavo di alimentazione regolabile in altezza; versioni da terra, parete e soffitto caratterizzate da un braccio curvo che sostiene la testa orientabile, permettendo di scegliere la direzione del fascio luminoso.

With its suspension, wall, ceiling and floor indoor/outdoor versions, Dip brings light to where it is needed, enhancing residential and commercial environments with class and elegance. The minimalist design of the fixtures is emphasized by a careful selection of specific finishes for each type of installation which in the indoor ground version, work in combination with the black marquina marble or travertine. Suspension version with height-adjustable power supply cable; floor, wall and ceiling versions characterized by a curved arm that supports the adjustable head, allowing the direction of the light beam to be chosen.

CODICE CODE	FONTE LUMINOSA LIGHT SOURCES	kg
 ET08416.170.0527	Potenza assorbita apparecchio / Luminaire power consumption 18W	20,00
 ET08427.170.0527	Flusso luminoso apparecchio / Luminaire luminous flux 1931lm	
 ET08428.170.0527	2700K Ra>90 220-240V AC dimmable (Push DIM)	
ET08434.170.0527	 IP65 	
	Fornito completo di interruttore push, cavo 3m e spina Supplied complete with push switch, 3m cable and plug	
 ET08416.170.0427	Potenza assorbita apparecchio / Luminaire power consumption 18W	20,00
 ET08427.170.0427	Flusso luminoso apparecchio / Luminaire luminous flux 1931lm	
 ET08428.170.0427	3000K Ra>90 220-240V AC dimmable (Push DIM)	
ET08434.170.0427	 IP65 	
	Fornito completo di interruttore push, cavo 3m e spina Supplied complete with push switch, 3m cable and plug	

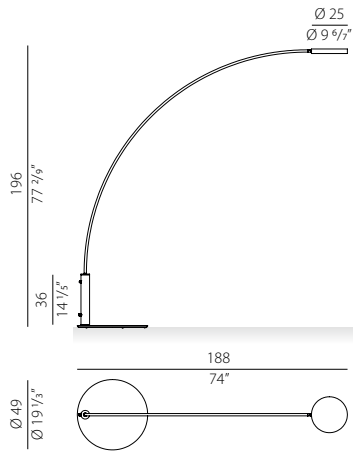

Fotometrie disponibili www.panzeri.it / Photometric data available at www.panzeri.it

CODICI COLORI DISPONIBILI / COLOUR CODES AVAILABLE

- 16** corten / corten
- 27** verde oliva materico / textured olive green
- 28** bianco soft materico / textured soft white
- 34** grigio micaceo / micaceous grey



VERSIONE INDOOR A PAGINA 36 / INDOOR VERSION ON PAGE 36



FIREFLY IN THE SKY

Matteo Thun 2019

Registered Design



Firefly in the sky è un apparecchio a batteria da tavolo. La testa removibile racchiude sistema di aggancio magnetico, batteria ricaricabile tramite USB-C, sorgente LED e comando Step DIM a 5 regolazioni di intensità luminosa. In funzione delle condizioni di utilizzo per una ricarica di circa 4 ore si stima un'autonomia di circa 6 ore con intensità della luce al 100% e di circa 24 ore con intensità della luce al 25%. Base antiscivolo già in dotazione. Verde oliva materico, bianco soft materico, terracotta naturale materico e corten si aggiungono alle finiture disponibili nero satinato, bronzo e champagne.

Firefly in the sky is a battery table lamp. The removable head contains magnetic coupling system, rechargeable battery via USB-C, LED source and Step DIM control with 5 light intensity settings. Depending on the conditions of use for a recharge of approximately 4 hours, an autonomy of approximately 6 hours is estimated with 100% light intensity and approximately 24 hours with 25% light intensity. Anti-slip base included. Textured olive green, textured soft white, textured natural terracotta and corten are added to matte black, bronze and champagne finishes available.

	CODICE CODE	FONTI LUMINOSE LIGHT SOURCES	kg
	C07805.011.0514	Potenza assorbita apparecchio / Luminaire power consumption 2W	1,06
	C07806.011.0514	Flusso luminoso apparecchio / Luminaire luminous flux 134lm	
	C07816.011.0514	2700K Ra>90 5V DC battery Dimmable (Step DIM)	
	C07817.011.0514	IP65	
	C07827.011.0514	Interruttore incluso / Switch included	
	C07828.011.0514 C07829.011.0514	In funzione delle condizioni di utilizzo per una ricarica di circa 4 ore si stima un'autonomia di circa 6 ore con intensità della luce al 100% e di circa 24 ore con intensità della luce al 25%. Indicatore LED per lo stato di carica. La carica avviene tramite USB-C. Caricabatteria e cavetto inclusi.	
		Depending on the conditions of use for a recharge of approximately 4 hours, an autonomy of approximately 6 hours is estimated with 100% light intensity and approximately 24 hours with 25% light intensity. LED indicator for the load status. Charging takes place via USB-C. Battery charger and cable Included.	

	PE07805.011.0514	Potenza assorbita apparecchio / Luminaire power consumption 2W	0,91
	PE07806.011.0514	Flusso luminoso apparecchio / Luminaire luminous flux 134lm	
	PE07816.011.0514	2700K Ra>90 5V DC battery Dimmable (Step DIM)	
	PE07817.011.0514	IP65	
	PE07827.011.0514 PE07828.011.0514 PE07829.011.0514	Fornito completo di picchetto di fissaggio al suolo, interruttore incluso Supplied with peg to fix to the ground, switch included	
		In funzione delle condizioni di utilizzo per una ricarica di circa 4 ore si stima un'autonomia di circa 6 ore con intensità della luce al 100% e di circa 24 ore con intensità della luce al 25%. Indicatore LED per lo stato di carica. La carica avviene tramite USB-C. Caricabatteria e cavetto inclusi.	
		Depending on the conditions of use for a recharge of approximately 4 hours, an autonomy of approximately 6 hours is estimated with 100% light intensity and approximately 24 hours with 25% light intensity. LED indicator for the load status. Charging takes place via USB-C. Battery charger and cable Included.	



reddot winner 2020

FIREFLY IN THE SKY

Matteo Thun 2019

Registered Design

CODICE
CODE

FONTI LUMINOSE
LIGHT SOURCES

kg

YRM07802.010

Vassoio per ricarica multipla di massimo 10 modelli Firefly in the Sky.
Multiple charging tray for up to 10 Firefly in the Sky models.

4,03

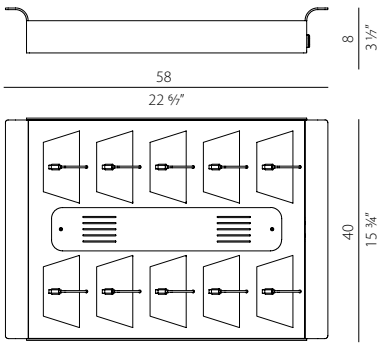

Fotometrie disponibili www.panzeri.it / Photometric data available at www.panzeri.it

CODICI COLORI DISPONIBILI / COLOUR CODES AVAILABLE

05 champagne
champagne

06 nero satinato
matte black

16 corten
corten

17 bronzo
bronze

27 verde oliva materico
textured olive green

28 bianco soft materico
textured soft white

29 terracotta naturale materico
textured natural terracotta

02 nero
black









Lampada a sospensione, tavolo, terra e picchetto studiata per esterni. Paralume in rattan sintetico intrecciato a mano colore marrone e stelo in alluminio/ottone (versione da tavolo, terra e picchetto). Diffusore in policarbonato trasparente con portalampana E27. Diffusore con attacco a baionetta studiato per permettere una facile rimozione per l'eventuale ritiro del paralume durante l'inverno. Versione a sospensione fornita con 1 cavo di alimentazione in colore nero (versione da 90 equipaggiata anche con 1 cavo di sospensione in acciaio). Disponibili accessori per fissaggio a parete. Ideale per zone living esterne o illuminazione di giardini.

Outdoor lamp in the suspension, table, floor and peg versions. Lampshade in hand-woven synthetic brown rattan and body in aluminium/brass (table, floor and peg versions). Transparent polycarbonate diffuser with E27 lamp socket. Diffuser with bayonet fitting, designed for an easy removal of the lampshade during the winter. Suspended version supplied with 1 black power cable (version 90 also equipped with 1 suspension steel cable). Available accessories for wall fixing. Ideal for outdoor living areas or garden lighting.

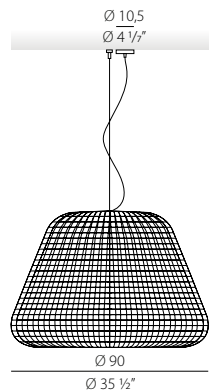
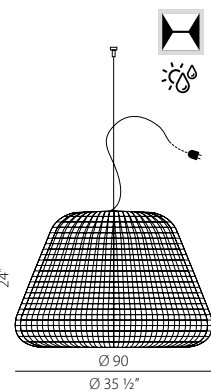
CODICE CODE		FONTI LUMINOSE LIGHT SOURCES	kg
 <p>Versione con rosone IP20 Canopy version IP20</p> <p>Ø 10,5 Ø 4 1/2"</p> <p>Ø 35 Ø 13 3/4"</p> <p>25 9 7/8"</p>	EL04744.035.0000	LED retrofit bulb E27 (L max 125mm - Ø max 65mm) max 53W E27	2,49
 <p>Versione con O-Ring IP65 O-Ring version IP65</p> <p>Ø 10,5 Ø 4 1/2"</p> <p>Ø 35 Ø 13 3/4"</p>		IP65 	
Fornito completo di cavo di collegamento 4,5m, spina, rosone, o-ring in silicone, moschettone. IP65 solo versione con spina Supplied with 4,5m cable, plug, canopy, silicone o-ring, hook. IP65 only plug version			

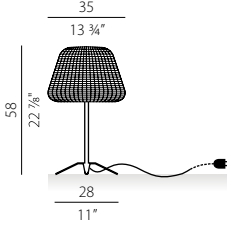

 <p>Versione con rosone IP20 Canopy version IP20</p> <p>Ø 10,5 Ø 4 1/2"</p> <p>Ø 50 Ø 19 3/4"</p> <p>34 13 1/4"</p>	EL04744.050.0000	LED retrofit bulb E27 (L max 125mm - Ø max 65mm) max 53W E27	4,16
 <p>Versione con O-Ring IP65 O-Ring version IP65</p> <p>Ø 10,5 Ø 4 1/2"</p> <p>Ø 50 Ø 19 3/4"</p>		IP65 	
Fornito completo di cavo di collegamento 4,5m, spina, rosone, o-ring in silicone, moschettone. IP65 solo versione con spina Supplied with 4,5m cable, plug, canopy, silicone o-ring, hook. IP65 only plug version			

 <p>Versione con rosone IP20 Canopy version IP20</p> <p>Ø 10,5 Ø 4 1/2"</p> <p>Ø 90 Ø 35 1/2"</p> <p>61 24"</p>	EL04744.090.0000	LED retrofit bulb E27 (L max 125mm - Ø max 65mm) max 53W E27	11,37
 <p>Versione con spina IP65 Version plug IP65</p> <p>Ø 10,5 Ø 4 1/2"</p> <p>Ø 90 Ø 35 1/2"</p>		IP65 	
Fornito completo di cavo di collegamento 4,5m, spina e rosone. IP65 solo versione con spina Supplied with 4,5m cable, plug and canopy. IP65 only plug version			

 <p>Versione da tavolo</p> <p>35 13 3/4"</p> <p>58 22 7/8"</p> <p>28 11"</p>	EC04744.035.0000	LED retrofit bulb E27 (L max 125mm - Ø max 65mm) max 53W E27	3,36
IP65 			
Fornito con interruttore Supplied with switch			

RALPH

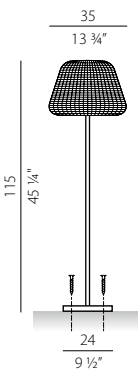
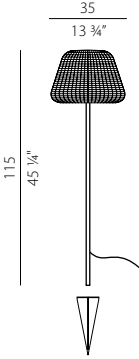
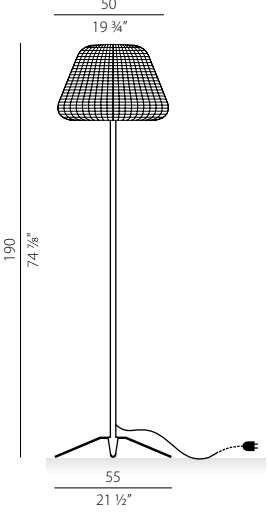
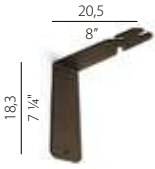
Officina Panzeri 2011

	CODICE CODE	FONTI LUMINOSE LIGHT SOURCES	kg
	ET04744.035.0000	LED retrofit bulb E27 (L max 125mm - Ø max 65mm) max 53W E27 IP65 <input type="checkbox"/> Fornito completo di base. Da fissare al suolo Supplied complete with base. To be fixed to the ground	3,42
	PE04744.035.0000	LED retrofit bulb E27 (L max 125mm - Ø max 65mm) max 53W E27 IP65 <input type="checkbox"/> Fornito completo di picchetto di fissaggio al suolo, spina e interruttore Supplied with peg to fix to the ground, plug and switch	3,84
	ET04744.050.0000	LED retrofit bulb E27 (L max 125mm - Ø max 65mm) max 53W E27 IP65 <input type="checkbox"/> Fornito completo di base, interruttore e spina Supply with base, switch and plug	9,25
	M4744 A	Staffa per fissaggio a parete in alluminio plastificato. Accessorio per EL047__035.0000 Wall fixing bracket in plasticised aluminium. Accessory for EL047__035.0000	0,59
	M47 T	Picchetto per il fissaggio al suolo per ET047__050.0000. Peg for ground fixing for ET047__050.0000.	0,87

Fotometrie disponibili www.panzeri.it / Photometric data available at www.panzeri.it

CODICI COLORI DISPONIBILI / COLOUR CODES AVAILABLE

44 marrone metallizzato
metallized brown



paralume marrone
brown lampshade





Una famiglia di prodotti che rappresenta un prestigioso connubio tra classicità e modernità. La sapiente unione di forme che evocano il passato, materiali raffinati e tecnologie contemporanee crea un prodotto senza tempo, in grado di esaltare la texture del vetro cattedrale attraverso una luce morbida e diffusa. Roma diventa assoluta protagonista dello spazio che occupa grazie al suo carattere forte e distintivo. Versione da terra per esterni. Completano la famiglia diverse versioni per interno.

A family of products that represents a prestigious blend of classicism and modernity. The clever combination of shapes that evoke the past, refined materials and contemporary technology creates a timeless product that enhances the texture of cathedral glass through soft, diffused light. Roma becomes the absolute protagonist of the space it occupies thanks to its strong and distinctive character. Floor-standing version for outdoors. Several indoor versions complete the family.

CODICE CODE	FONTI LUMINOSE LIGHT SOURCES	kg
-------------	------------------------------	----



ET14817.185.0510

Potenza assorbita apparecchio / Luminaire power consumption 72W
Flusso luminoso apparecchio / Luminaire luminous flux 5048lm
2700K Ra>90 24V DC

56,00

IP65

Fornito completo di cavo 5m. Driver non incluso
Supplied with 5m cable. Driver not included

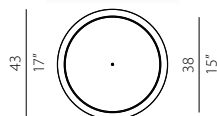
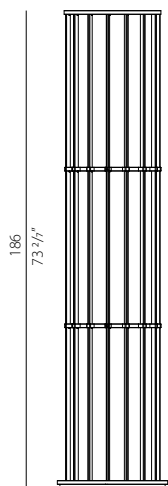

ET14817.200.0510

Potenza assorbita apparecchio / Luminaire power consumption 72W
Flusso luminoso apparecchio / Luminaire luminous flux 5048lm
2700K Ra>90 24V DC

72,00

IP65

Basamento in travertino. Fornito completo di cavo 5m.
Driver non incluso
Travertine base. Supplied with 5m cable
Driver not included

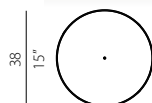
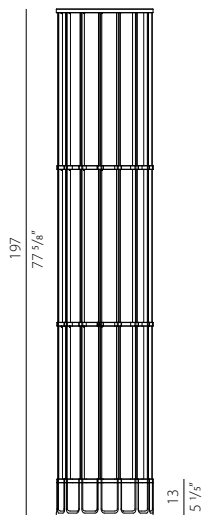

Fotometrie disponibili www.panzeri.it / Photometric data available at www.panzeri.it

CODICI COLORI DISPONIBILI / COLOUR CODES AVAILABLE

17 bronzo
bronze

VERSIONE INDOOR A PAGINA 72 / INDOOR VERSION ON PAGE 72













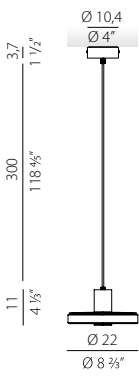

Lampada a sospensione, parete e paletto per esterni IP65 con testa in vetro colato e piattello in alluminio tornito. Paletto in alluminio disponibile in tre altezze, completo di sistema di fissaggio per installazione a terra. Versione parete con braccio rigido di fissaggio a parete. Finiture grigio micaceo, legno verniciato con accessori in ottone satinato, corten. Ideale per hotel, ristoranti, residenze.

Suspension, wall lamp and bollard for outdoor IP65 with cast glass head and turned aluminium plate. Bollard available in three heights, complete with fixing system for ground installation. Wall version with fixed wall arm. Micaceous grey, varnished wood with matte brass accessories and corten finishes are available. Ideal for hotels, restaurants, residences.

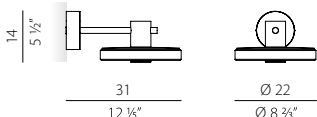
	CODICE CODE	FONTE LUMINOSA LIGHT SOURCES	kg
 	ET04816.045.0201 ET04834.045.0201 ET04845.045.0201	Potenza assorbita apparecchio / Luminaire power consumption 8W Flusso luminoso apparecchio / Luminaire luminous flux 594lm 2700K Ra>80 220-240V AC ON-OFF IP65 IK06	3,43
 	ET04816.070.0201 ET04834.070.0201 ET04845.070.0201	Potenza assorbita apparecchio / Luminaire power consumption 8W Flusso luminoso apparecchio / Luminaire luminous flux 594lm 2700K Ra>80 220-240V AC ON-OFF IP65 IK06	3,70
 	ET04816.095.0201 ET04834.095.0201 ET04845.095.0201	Potenza assorbita apparecchio / Luminaire power consumption 8W Flusso luminoso apparecchio / Luminaire luminous flux 594lm 2700K Ra>80 220-240V AC ON-OFF IP65 IK06	3,82
 	YTF04800.012	Tirafondi per il fissaggio al suolo. Anchor bolts for ground fixing.	0,22

VENEXIA

Matteo Thun 2020

	CODICE CODE	FONTI LUMINOSE LIGHT SOURCES	kg
	 EL04816.022.0201	Potenza assorbita apparecchio / Luminaire power consumption 8W	3,40
	 EL04819.022.0201	Flusso luminoso apparecchio / Luminaire luminous flux 594lm	
	 EL04834.022.0201	2700K Ra>80 220-240V AC ON-OFF  IP65 IK06 	
	 EA04816.022.0201	Potenza assorbita apparecchio / Luminaire power consumption 8W	3,60
	 EA04819.022.0201	Flusso luminoso apparecchio / Luminaire luminous flux 594lm	
	 EA04834.022.0201	2700K Ra>80 220-240V AC ON-OFF  IP65 IK06 	

Fotometrie disponibili www.panzeri.it / Photometric data available at www.panzeri.it

CODICI COLORI DISPONIBILI / COLOUR CODES AVAILABLE

16 corten corten	34 grigio micaceo micaceous grey	45 legno/ottone satinato wood/matte brass	19 ottone satinato matte brass
----------------------------	--	---	--



archiproducts
 DESIGN AWARDS
 —
 WINNER 2020

PROFILI / PROFILES

144	BROADWAY
126	BRONX
128	BROOKLYN
128	BROOKLYN OUT
128	BROOKLYN TRIM
133	CORNER
135	GIANO
138	HARLEM
140	KIPS
139	KIPS ROUND
141	MANHATTAN
145	NOOK



BRONX XG247

XG247_+LED+XM247_202.0099



Profilo in alluminio estruso ad incasso, completo di diffusore in policarbonato estruso, studiato per consentire l'installazione su pannelli in cartongesso di diverso spessore (12,5mm e 25mm). La sorgente luminosa è inserita a scorrimento senza incollaggio all'interno del diffusore in policarbonato estruso rimovibile a scatto, permettendo una semplice installazione.

Bronx is a recessed aluminium profile, provided with an extruded polycarbonate diffuser and designed to allow installation on plasterboard panels of different thicknesses (12,5 mm and 25 mm). The light source is sliding inside the extruded polycarbonate diffuser without gluing, removable by snap, allowing a simple installation.

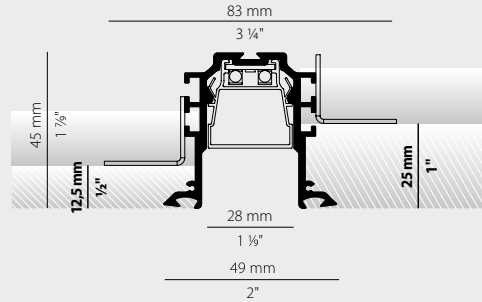

Electric options only with remote components	page 205
Dimming / Power supply	207-208
Technical information	210
Wiring diagram 1	210
UGR <19 depending on installation conditions	
Photometric data available at www.panzeri.it	

TRIMLESS PROFILE

	CODICE / CODE	L MM	L INCHES	NR. ADVISED	MM	INCHES	kg
Fornito completo di schermo diffusore	XG24701.050.0099	510	20"	2	515 x 50	20 3/8" x 2"	0,46
Supplied with diffuser	XG24702.050.0099	510	20"	2	515 x 50	20 3/8" x 2"	0,46
	XG24701.100.0099	1010	39 1/8"	2	1015 x 50	40" x 2"	0,88
	XG24702.100.0099	1010	39 1/8"	2	1015 x 50	40" x 2"	0,88
	XG24701.200.0099	2010	79 1/8"	3	2015 x 50	79 3/8" x 2"	1,74
	XG24702.200.0099	2010	79 1/8"	3	2015 x 50	79 3/8" x 2"	1,74
	XG24701.300.0099	3010	118 3/8"	4	3015 x 50	118 4/8" x 2"	2,61
	XG24702.300.0099	3010	118 3/8"	4	3015 x 50	118 4/8" x 2"	2,61

LED MODULE

	CODICE / CODE	L MM	L INCHES	MM	INCHES	W	LM	LM/M	NR. LED	LED	V
	XM005.050.0410	500	19 3/8"	62,5	2 1/2"	8,6W	1140lm	2280lm/m	64	3000K Ra>90	24V DC
	XM005.012.0410	125	5"	62,5	2 1/2"	2,15W	285lm	2280lm/m	16	3000K Ra>90	24V DC

Matrice di compatibilità LED / Profili pag. 146 / LED Profile Matrix page 146

CODICI COLORI DISPONIBILI / COLOUR CODES AVAILABLE

- 01** bianco white
- 02** nero black

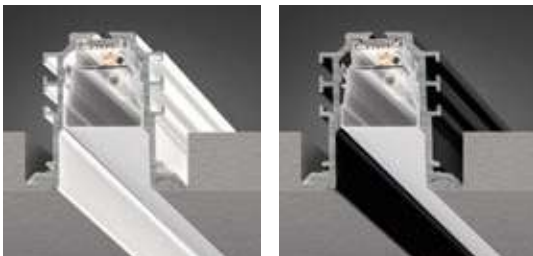

XM24701.302.0099**XM24702.302.0099**

Elemento di collegamento per due linee di profili componibili con angolo di giunzione piano di 90°, per installazione incassata a scomparsa.
Connection joint for two lines of modular profiles with level junction 90°, for total built-in installation.

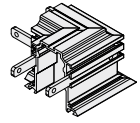

0,10

XM24700.301.0099

Kit di giunzione lineare.
Linear junction kit.

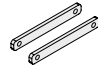

0,03

XM24701.202.0099**XM24702.202.0099**

Coppia di testate di chiusura con viti.
Pair of end caps with screws.

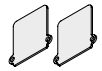

0,02

XM24700.201.0099

Kit di staffe di fissaggio su cartongesso.
Drywall fixing bracket kit.

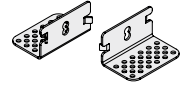

0,03

XM2033/34/32/31-S

Cavi di alimentazione.
Power cables.



0,01

XM247-ALU CUT

Taglio a richiesta di estruso di alluminio.
Extruded aluminum cut on request.

XM247-SCREEN CUT

Taglio a richiesta di schermo in policarbonato.
Polycarbonate screen cut on request.

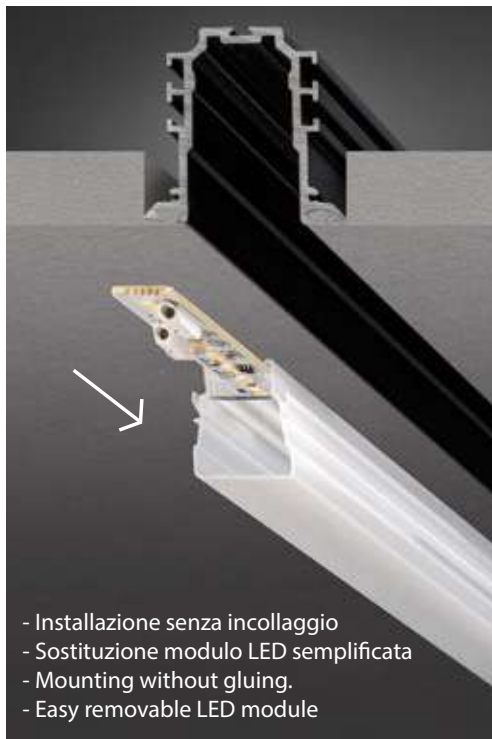

- Installazione senza incollaggio
- Sostituzione modulo LED semplificata
- Mounting without gluing.
- Easy removable LED module

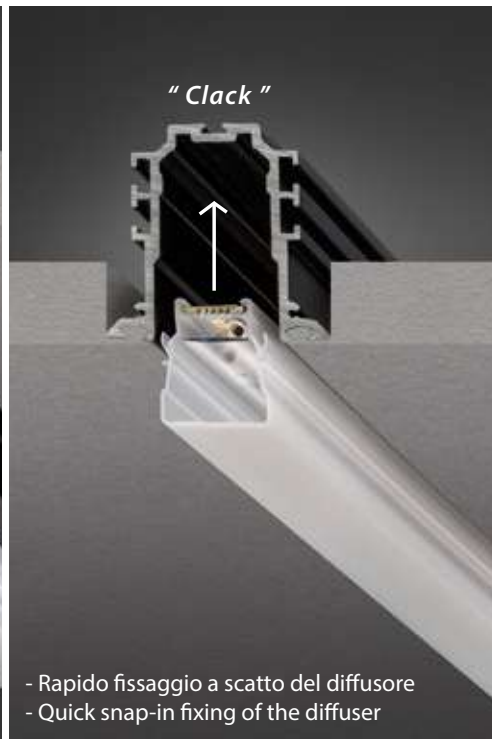

- Rapido fissaggio a scatto del diffusore
- Quick snap-in fixing of the diffuser

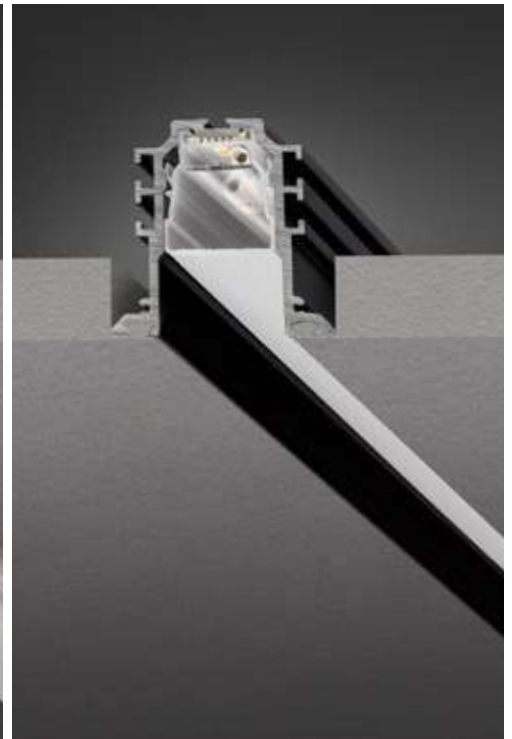

L'Ufficio Tecnico Panzeri è disponibile a supporto della progettazione / Panzeri Technical Department is available to support the design

BROOKLYN
XG2033

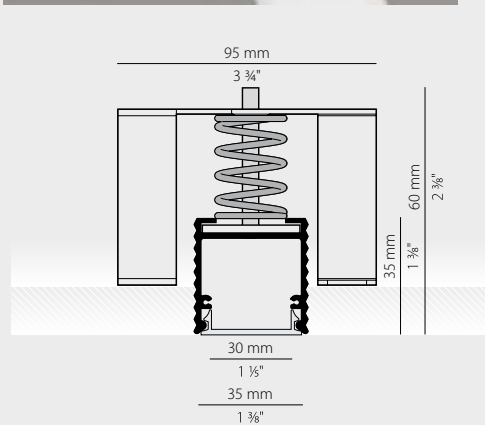

BROOKLYN TRIM
XG2034

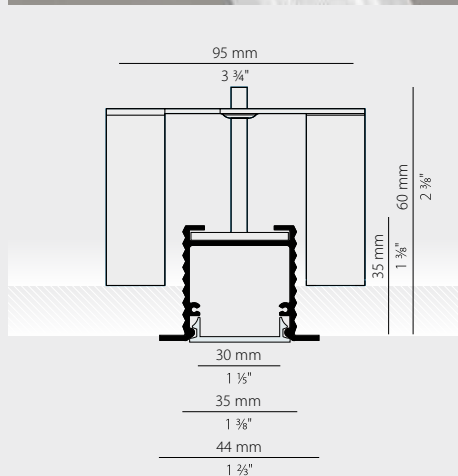

BROOKLYN OUT
XP2033

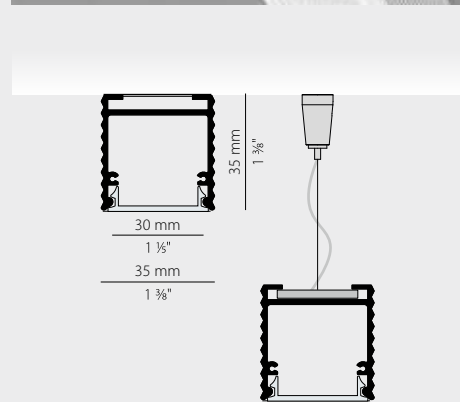

Sistema modulare LED in alluminio estruso verniciato bianco sezionabile, da incasso a scomparsa totale (trimless), per applicazioni in verticale o orizzontale per cartongesso/laterizio. Doppi schermi: il primo monouso per rasatura, stuccatura e verniciatura, il secondo definitivo opalino o microprismato. Per una corretta e facile installazione nel cartongesso sono disponibili farfalle micro regolabili opzionali, applicabili ogni 400mm ca. Moduli LED multipli da 500mm frazionabili ogni 62,5mm 3000K 8,6W 24V. Moduli LED da 125mm 3000K 2,2W 24V, completi di 2 cavetti per collegamento. Predisporre, se necessari, eventuali appendimenti.

Modular LED system in white painted extruded aluminium (trimless), dividable, and fully recessed wall for vertical or horizontal use in drywall/concrete. Two screens: the first disposable for shaving, plastering and painting, the second definitive in opaline or microprismatic finish. For a quick and easy installation in drywall, are available micro adjustable wings nut optional, applicable every 400mm approx. Multiple LED modules (500mm long) divisible every 62,5mm 3000K 8,6W 24V. Modules (125mm long) 3000K 2,2W 24V, complete with 2 connection cables. Prepare, if necessary, any hangings to support the system.

Sistema modulare LED in alluminio estruso verniciato bianco sezionabile, da incasso con bordo (trim), per applicazioni in verticale o orizzontale per cartongesso/laterizio. Per una corretta e facile installazione nel cartongesso sono disponibili farfalle opzionali, applicabili ogni 400mm ca. Moduli LED multipli da 500mm frazionabili ogni 62,5mm 3000K 8,6W 24V. Moduli LED da 125mm 3000K 2,2W 24V, completi di 2 cavetti per collegamento. Predisporre, se necessari, eventuali appendimenti.

Modular LED system in extruded aluminium painted white, for recessed installation with border (trim), for vertical or horizontal application in drywall /brick. Wings nut (an optional) are available for correct and simple installation in false ceiling applicable every 400mm approx. Multiple 500mm LED modules 8,6W 24V 3000K divisible every 62,5mm. 125mm LED modules 3000k 2,2W 24V complete with 2 connection cable. Prepare any suspensions, if necessary.

Sistema modulare LED in alluminio estruso verniciato bianco (nero a richiesta) sezionabile, da parete/plafone o a sospensione. Moduli LED multipli da 500mm frazionabili ogni 62,5mm 3000K 8,6W 24V. Moduli LED da 125mm 3000K 2,2W 24V, completi di 2 cavetti per collegamento.

Modular LED system in extruded aluminium painted white (black on request) sectionable, da parete/plafone o a sospensione. Moduli LED multipli da 500mm frazionabili ogni 62,5mm 3000K 8,6W 24V. Moduli LED da 125mm 3000K 2,2W 24V, complete with 2 connection cables.

Electric options only with remote components	page 205
Dimming / Power supply	207/208
Technical information	210
Wiring diagram 1	210
UGR <19 depending on installation conditions	
Photometric data available at www.panzeri.it	

L'Ufficio Tecnico Panzeri è disponibile a supporto della progettazione / Panzeri Technical Department is available to support the design

TRIMLESS PROFILE

	CODICE / CODE	L MM	L INCHES	NR. ADVISED	MM	INCHES	kg
Fornito completo di schermo monouso e schermo diffusore opalino Supplied with disposable screen and opal diffuser	XG2033-50TRACK	510	20"	2	515 x 40	20 3/8" x 1 3/8"	0,38
	XG2033-100TRACK	1010	39 1/2"	2	1015 x 40	40" x 1 3/8"	0,83
	XG2033-200TRACK	2010	79 1/2"	3	2015 x 40	79 3/8" x 1 3/8"	1,48
	XG2033-300TRACK	3010	118 3/8"	4	3015 x 40	118 1/2" x 1 3/8"	2,21
Fornito completo di schermo monouso e schermo diffusore microprismato Supplied with disposable screen and micro-prismatic diffuser	XG2033-50TRACK PR	510	20"	2	515 x 40	20 3/8" x 1 3/8"	0,38
	XG2033-100TRACK PR	1010	39 1/2"	2	1015 x 40	40" x 1 3/8"	0,83
	XG2033-200TRACK PR	2010	79 1/2"	3	2015 x 40	79 3/8" x 1 3/8"	1,48
	XG2033-300TRACK PR	3010	118 3/8"	4	3015 x 40	118 1/2" x 1 3/8"	2,21

TRIM PROFILE

	CODICE / CODE	L MM	L INCHES	NR. ADVISED	MM	INCHES	kg
Fornito completo di schermo diffusore opalino Supplied with opal diffuser	XG2034-50TRACK	510	20"	2	515 x 40	20 3/8" x 1 3/8"	0,32
	XG2034-100TRACK	1010	39 1/2"	2	1015 x 40	40" x 1 3/8"	0,67
	XG2034-200TRACK	2010	79 1/2"	3	2015 x 40	79 3/8" x 1 3/8"	1,25
	XG2034-300TRACK	3010	118 3/8"	4	3015 x 40	118 1/2" x 1 3/8"	1,90
Fornito completo di schermo diffusore microprismato Supplied with micro-prismatic diffuser	XG2034-50TRACK PR	510	20"	2	515 x 40	20 3/8" x 1 3/8"	0,32
	XG2034-100TRACK PR	1010	39 1/2"	2	1015 x 40	40" x 1 3/8"	0,67
	XG2034-200TRACK PR	2010	79 1/2"	3	2015 x 40	79 3/8" x 1 3/8"	1,25
	XG2034-300TRACK PR	3010	118 3/8"	4	3015 x 40	118 1/2" x 1 3/8"	1,90

CEILING SUSPENSION

	CODICE / CODE	L MM	L INCHES	kg
Fornito completo di schermo diffusore opalino Supplied with opal diffuser	XP2033-50TRACK	525	20 3/8"	0,34
	XP2033-100TRACK	1025	40 3/8"	0,68
	XP2033-200TRACK	2025	79 7/8"	1,32
	XP2033-300TRACK	3025	119 1/2"	1,94
Fornito completo di schermo diffusore microprismato Supplied with micro-prismatic diffuser	XP2033-50TRACK PR	525	20 3/8"	0,34
	XP2033-100TRACK PR	1025	40 3/8"	0,68
	XP2033-200TRACK PR	2025	79 7/8"	1,32
	XP2033-300TRACK PR	3025	119 1/2"	1,94

LED MODULE

	CODICE / CODE	L MM	L INCHES	MM	INCHES	W	W/M	LM	LM/M	NR. LED	LED	V
	XM006.050.0410	500	19 3/8"	62,5	2 1/2"	8,6W	17,2W/m	1140lm	2280lm/m	64	3000K Ra>90	24V DC
	XM006.012.0410	125	5"	62,5	2 1/2"	2,15W	17,2W/m	258lm	2280lm/m	16	3000K Ra>90	24V DC
	YLR005.010.0410	5000	197"	50	2"		9,6W/m		1335lm/m	200/m	3000K Ra>80	24V DC
	YLR006.017.0410	5000	197"	42	1 3/8"		16,8W/m		2285lm/m	200/m	3000K Ra>90	24V DC

Altre temperature di colore disponibili a pag. 205 / Other colour temperatures available on page 205

Matrice di compatibilità LED / Profili pag. 146 / LED Profile Matrix page 146

DIFFUSERS

CODICE / CODE	L MM	L INCHES		kg
XM2033/34/45/46-600S	6000 x 30	236 3/8" x 1 1/8"	Schermo diffusore in policarbonato estruso con finitura opalina, di lunghezza 6000mm (236,2"). Extruded polycarbonate diffuser with opaline finish, 6000mm (236,2") long.	0,47
XM2033/34/45/46-900S	9000 x 30	354 3/8" x 1 1/8"	Schermo diffusore in policarbonato estruso con finitura opalina, di lunghezza 9000mm (354,3"). Extruded polycarbonate diffuser with opaline finish, 9000mm (354,3") long.	0,69
XM2033/34/45/46-1200S	12000 x 30	472 3/8" x 1 1/8"	Schermo diffusore in policarbonato estruso con finitura opalina, di lunghezza 12000mm (472,4"). Extruded polycarbonate diffuser with opaline finish, 12000mm (472,4") long.	0,93
XM2033/34/45/46-600S PR	6000 x 30	236 3/8" x 1 1/8"	Schermo diffusore in policarbonato estruso microprismatico, di lunghezza 6000mm (236,2"). Micro-prismatic extruded polycarbonate diffuser, 6000mm (236,2") long.	0,47
XM2033/34/45/46-900S PR	9000 x 30	354 3/8" x 1 1/8"	Schermo diffusore in policarbonato estruso microprismatico, di lunghezza 9000mm (354,3"). Micro-prismatic extruded polycarbonate diffuser, 9000mm (354,3") long.	0,69
XM2033/34/45/46-1200S PR	12000 x 30	472 3/8" x 1 1/8"	Schermo diffusore in policarbonato estruso microprismatico, di lunghezza 12000mm (472,4"). Micro-prismatic extruded polycarbonate diffuser, 12000mm (472,4") long.	0,93

ACCESSORI / ACCESSORIES
XM2033-U90

Elemento di collegamento per due linee di profili componibili con angolo di giunzione piano di 90°, per installazione a incasso a scomparsa.
Connection joint for two lines of modular profiles with level junction 90°, for total built-in installation.

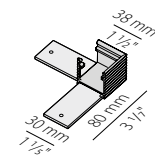

0,11

XM2033-U90 XP

Elemento di collegamento per due linee di profili componibili con angolo di giunzione piano di 90°, per installazione a sospensione o a soffitto.
Connection joint for two lines of modular profiles with level junction 90°, for suspended or ceiling installation.

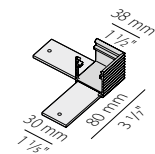

0,11

XM2034-U90

Elemento di collegamento per due linee di profili componibili con angolo di giunzione piano di 90°, per installazione a incasso.
Connection joint for two lines of modular profiles with level junction 90°, for built-in installation.

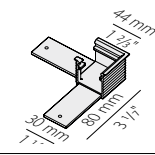

0,22

XM2033-UT

Giunzione piana per tre profili a "T", per installazione a incasso a scomparsa.
Three profiles "T" level junction, for total built-in installation.

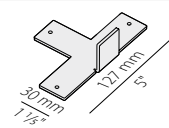

0,17

XM2033-X

Giunzione piana per quattro profili a "X", per installazione a incasso a scomparsa.
Four profiles "X" level junction, for total built-in installation.

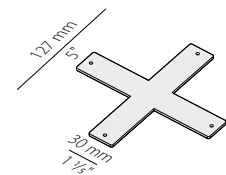

0,16

XM2033/34-ANG

Giunzione perpendicolare per due profili con taglio a 45°.
Two profiles perpendicular junction with 45° cut.

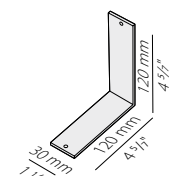

0,15

XM2033-U45

Giunzione piana per due profili con taglio a 45°, per installazione a incasso a scomparsa.
Two profiles level junction with 45° cut, for total built-in installation.

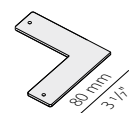

0,01

	kg
XM2033/34-U Giunzione lineare. Linear junction.	0,06
XM2033/34-WHI Riflettore bianco di lunghezza 1000mm (39,4") sezionabile. White reflector with 1000mm (39,4") length to be cut.	0,23
XM2033-T Coppia di testate di chiusura con viti per profili incassati a scomparsa. Pair of end caps with screws for trimless recessed profiles.	0,02
XM2033-T1 Coppia di testate di chiusura con viti per profili installati a sospensione o a soffitto. Pair of end caps with screws for suspended or ceiling mounted profiles.	0,02
XM2034-T Coppia di testate di chiusura con viti per profili incassati. Pair of end caps with screws for recessed profiles.	0,17
XM2033-F Farfalla di fissaggio su cartongesso per profili incassati a scomparsa. Drywall fixing bracket for trimless recessed profiles.	0,07
XM2034-F Farfalla di fissaggio su cartongesso per profili incassati. Drywall fixing bracket for recessed profiles.	0,17
XM2033/34-L Coppia di piastrine di fissaggio per incasso in muratura. Pair of fixing plates for recessed installation in brick wall or concrete.	0,04
XM-KIT-S Kit di sospensione singolo. Single suspension kit.	0,05
XM2033/34/38/39P Piastrina per appendimento. Plate for hanging.	0,01
XM2033-T120W Kit di alimentazione con rosone bianco e alimentatore 120W. Power supply kit with white canopy and 120W driver.	1,22
XM2033-T200W DIM Kit di alimentazione con rosone bianco e alimentatore 200W/24V dimmerabile DALI/Push DIM. Power supply kit with white canopy and 200W/24V DALI/Push DIM dimmable driver.	1,61
XM2033-ST120W Kit di alimentazione con rosone bianco, alimentatore 120W, cavo di alimentazione di lunghezza 2,2m (86,6"). Power supply kit with white canopy, 120W driver, power cable with length 2,2m (86,6").	1,39
XM2033-ST200W DIM Kit di alimentazione con rosone bianco, alimentatore 200W/24V dimmerabile DALI/Push DIM, cavo di alimentazione di lunghezza 2,2m (86,6"). Power supply kit with white canopy, 200W/24V DALI/Push DIM dimmable driver, power cable with length 2,2m (86,6").	1,72
XM2033/34/32/31-S Cavi di alimentazione. Power cables.	0,01
XM2033-A Coppia di copriluce adesivi per giunzioni. Pair of adhesive light covers for junctions.	

ACCESSORI / ACCESSORIES

kg

XM231/32-P

Distanziale per installazione a soffitto/parete.
Spacer for ceiling/wall installation.



0,08

XM2033-ALU CUT

Taglio a richiesta di estruso di alluminio.
Extruded aluminum cut on request.

XM2033-SCREEN CUT

Taglio a richiesta di schermo in policarbonato.
Polycarbonate screen cut on request.



CORNER XG2045



XG2045-__+LED+XM2045-T

Sistema modulare a soffitto o parete caratterizzato dal posizionamento arretrato della sorgente. L'installazione prevede l'ancoraggio alle superfici perimetrali e l'inserimento finale del pannello in cartongesso a filo con l'estruso, per un effetto di luce a scomparsa.

Modular LED system in extruded aluminum white painted, for wall or ceiling perimeter installation, characterized by the back positioning of the light source. The installation foresees the fixation of profiles to side surfaces and the final placing of plasterboard panel flush with the extruded body, to have a total recessed light effect.

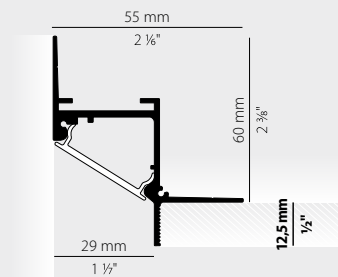

Electric options only with remote components page 205

Dimming / Power supply 207/208

Technical information 210

Wiring diagram 1-2 210

UGR <19 depending on installation conditions

Photometric data available at www.panzeri.it

TRIMLESS PROFILE

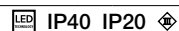

	CODICE / CODE	L MM	L INCHES	kg
Fornito completo di schermo diffusore	XG2045-50TRACK	510	20"	0,45
Supplied with diffuser	XG2045-100TRACK	1010	39 3/8"	0,78
	XG2045-200TRACK	2010	79 1/8"	1,45
	XG2045-300TRACK	3010	118 3/8"	2,05

LED MODULE



	CODICE / CODE	L MM	L INCHES	MM	INCHES	W	W/M	LM	LM/M	NR. LED	LED	V
	XM006.050.0410	500	19 3/8"	62,5	2 1/2"	8,6W	17,2W/m	1140lm	2280lm/m	64	3000K Ra>90	24V DC
	XM006.012.0410	125	5"	62,5	2 1/2"	2,15W	17,2W/m	258lm	2280lm/m	16	3000K Ra>90	24V DC
	YLR005.010.0410	5000	197"	50	2"		9,6W/m		1335lm/m	200/m	3000K Ra>80	24V DC
	YLR006.017.0410	5000	197"	42	1 3/8"		16,8W/m		2285lm/m	200/m	3000K Ra>90	24V DC
	YLR007.022.0410	5000	197"	42	1 3/8"		22W/m		2950lm/m	240/m	3000K Ra>90	24V DC

Altre temperature di colore disponibili a pag. 205 / Other colour temperatures available on page 205

Matrice di compatibilità LED / Profili pag. 146 / LED Profile Matrix page 146

DIFFUSERS

CODICE / CODE	L MM	L INCHES		kg
XM2033/34/45/46-600S	6000 x 30	236 3/8" x 1 1/8"	Schermo diffusore in policarbonato estruso con finitura opalina, di lunghezza 6000mm (236,2"). Extruded polycarbonate diffuser with opaline finish, 6000mm (236,2") long.	0,47
XM2033/34/45/46-900S	9000 x 30	354 3/8" x 1 1/8"	Schermo diffusore in policarbonato estruso con finitura opalina, di lunghezza 9000mm (354,3"). Extruded polycarbonate diffuser with opaline finish, 9000mm (354,3") long.	0,69
XM2033/34/45/46-1200S	12000 x 30	472 4/8" x 1 1/8"	Schermo diffusore in policarbonato estruso con finitura opalina, di lunghezza 12000mm (472,4"). Extruded polycarbonate diffuser with opaline finish, 12000mm (472,4") long.	0,93

Fotometrie disponibili www.panzeri.it / Photometric data available at www.panzeri.it

CODICI COLORI DISPONIBILI / COLOUR CODES AVAILABLE

01 bianco
white

XM2045-U90 1

Elemento di collegamento per due linee di profili componibili con angolo di giunzione piano interno di 90°, per installazione perimetrale.
Connection joint for two lines of modular profiles with internal level junction 90°, for perimetral installation.

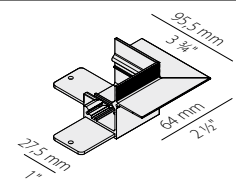

0,09

XM2045-U90 2

Elemento di collegamento per due linee di profili componibili con angolo di giunzione piano esterno di 90°, per installazione perimetrale.
Connection joint for two lines of modular profiles with external level junction 90°, for perimetral installation.

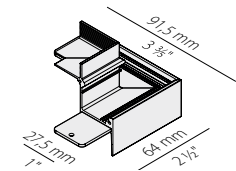

0,13

XM2045-ANG 3

Elemento di collegamento per due linee di profili componibili con angolo di giunzione perpendicolare interno di 90°, per installazione perimetrale.
Connection joint for two lines of modular profiles with internal perpendicular junction 90°, for perimetral installation.

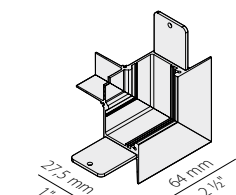

0,11

XM2045-ANG 4

Elemento di collegamento per due linee di profili componibili con angolo di giunzione perpendicolare esterno di 90°, per installazione perimetrale.
Connection joint for two lines of modular profiles with external perpendicular junction 90°, for perimetral installation.

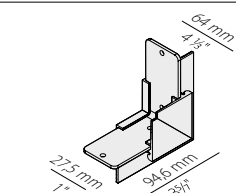

0,09

XM2045-U

Giunzione lineare.
Linear junction.

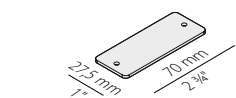

0,03

XM2045-T

Coppia di testate di chiusura con viti.
Pair of end caps with screws.



0,01

XM2045-CUT

Taglio lineare per moduli dritti.
Linear cut for straight modules.

L'Ufficio Tecnico Panzeri è disponibile a supporto della progettazione / Panzeri Technical Department is available to support the design

XM2045-U

Giunzione lineare
Linear junction

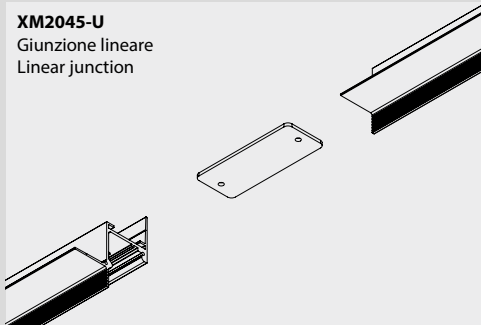
**XM2045-U90 1**

Angolo 1 piano 90° parete-parete / soffitto-soffitto misure esterne 64x64mm
Angle 1 horizontal 90° wall-wall / ceiling-ceiling, external measurements 64x64mm

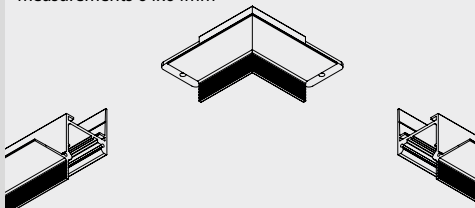
**XM2045-U90 2**

Angolo 2 piano 90° parete-parete / soffitto-soffitto misure esterne 64x64mm
Angle 2 horizontal 90° wall-wall / ceiling-ceiling, external measurements 64x64mm

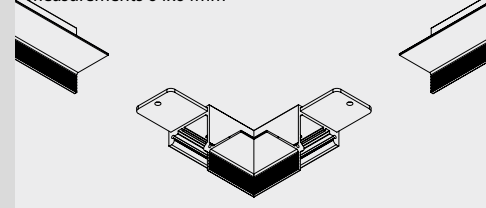
**XM2045-ANG 3**

Angolo 3 verticale 90° parete-soffitto/parete-parete misure esterne 64x64mm
Angle 3 vertical 90° wall-ceiling / wall-wall, external measurements 64x64mm

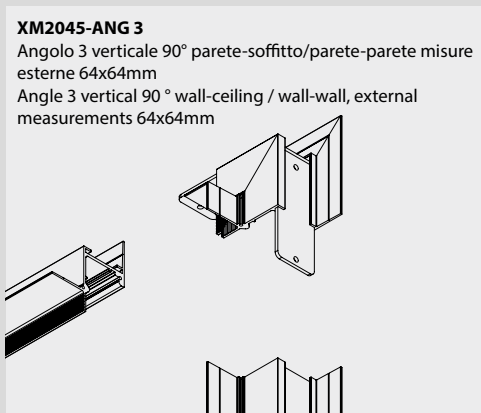
**XM2045-ANG 4**

Angolo 4 orizzontale 90° parete-parete misure esterne 64x64mm
Angle 4 horizontal 90° wall-wall, external measurements 64x64mm

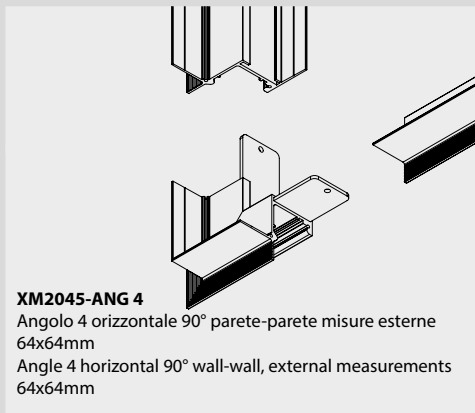



GIANO XP246

XP246__+LED+FEEDING KIT +XM246-__T



Sistema modulare in alluminio estruso disponibile in versione sospensione o parete. Sorgente luminosa composta da modulo LED a luce diretta e indiretta e driver ON-OFF con accensione separata o DALI/Push DIM da integrare all'interno del profilo. Finitura con vernice poliaccrilica in bianco o nero e finitura frontale del profilo liscia. Schermo in policarbonato estruso opale o microprismatico. Ideale per uffici, corridoi, scale.

Modular extruded aluminum wall and suspension system. Light source made of LED module with direct and indirect light and separate switching ON-OFF or DALI/Push DIM drivers to be integrated into the profile. Finish in polyacrylic paint in white or black and smooth front finish of the profile. Diffuser in opal or micro prismatic polycarbonate. Ideal for offices, corridors, stairways.

Electric options page 205

Technical information 210

Wiring diagram 1 210

UGR <19 depending on installation conditions

Photometric data available at www.panzeri.it

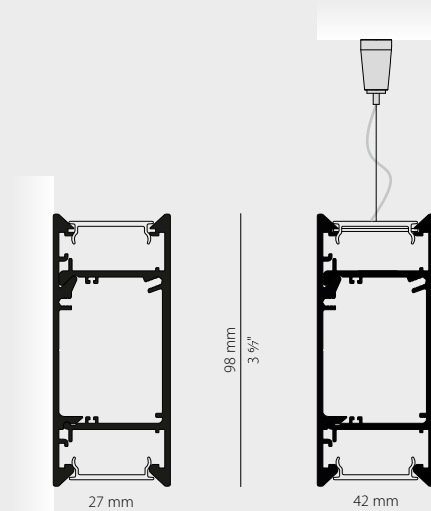

WALL SUSPENSION

IP40 850°

	CODICE / CODE	L MM	L INCHES	kg
Fornito completo di n.2 schermi diffusori opalini	XP24646.050.0099	515	20 3/4"	1,19
Supplied with n.2 opal diffuser	XP24648.050.0099	515	20 3/4"	1,19
	XP24646.100.0099	1015	40"	2,38
	XP24648.100.0099	1015	40"	2,38
	XP24646.200.0099	2015	79 3/8"	4,76
	XP24648.200.0099	2015	79 3/8"	4,76
	XP24646.300.0099	3015	118 4/8"	7,14
	XP24648.300.0099	3015	118 4/8"	7,14

LED MODULE





	CODICE / CODE	L MM	L INCHES	MM	INCHES	W	W/M	LM	LM/M	NR. LED	LED	V
	XM006.050.0410	500	19 3/8"	62,5	2 1/2"	8,6W	17,2W/m	1140lm	2280lm/m	64	3000K Ra>90	24V DC
	XM006.012.0410	125	5"	62,5	2 1/2"	2,15W	17,2W/m	258lm	2280lm/m	16	3000K Ra>90	24V DC
	YLR005.010.0410	5000	197"	50	2"		9,6W/m		1335lm/m	200/m	3000K Ra>80	24V DC
	YLR006.017.0410	5000	197"	42	1 3/8"		16,8W/m		2285lm/m	200/m	3000K Ra>90	24V DC

Altre temperature di colore disponibili a pag. 205 / Other colour temperatures available on page 205

Matrice di compatibilità LED / Profili pag. 146 / LED Profile Matrix page 146

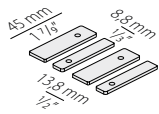
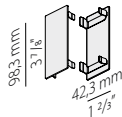
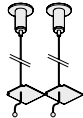
ACCESSORI / ACCESSORIES

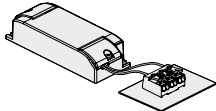
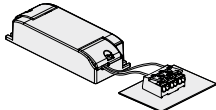
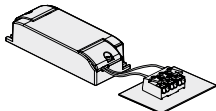
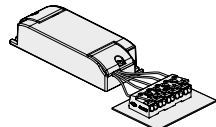
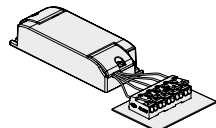
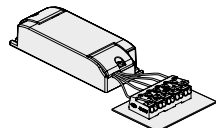
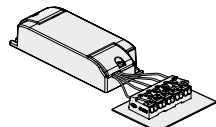
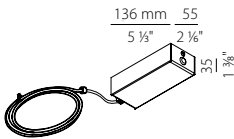
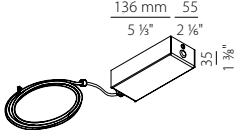
	kg
XM246-U Kit di giunzione lineare. Linear junction kit.	 0,04
XM246-01T XM246-02T Coppia di testate di chiusura. Pair of end caps.	 0,03
XM246-01-KIT-S XM246-02-KIT-S Coppia di kit di sospensione, con fune di acciaio di lunghezza 2000mm (78 4/5"). Pair of suspension kits, with 2000mm (78 4/5") long steel wire.	 0,12
XM246-01-KIT-S1 XM246-02-KIT-S1 Kit di sospensione singolo per giunzioni, con fune di acciaio di lunghezza 2000mm (78 4/5"). Single suspension kit for junctions, with 2000mm (78 4/5") long steel wire.	 0,06
XM30/24I Alimentatore LED, 30W 24V DC. LED driver, 30W 24V DC.	 0,04
XM60/24I Alimentatore LED, 75W 24V DC. LED driver, 75W 24V DC.	 0,30
XM120/24I Alimentatore LED, 120W 24V DC. LED driver, 120W 24V DC.	 0,28
XM35/24I DIM Alimentatore LED, 35W 24V DC, dimmerabile DALI/Push DIM. LED driver, 35W 24V DC, DALI/Push DIM dimmable.	 0,15
XM60/24I DIM Alimentatore LED, 60W 24V DC, dimmerabile DALI/Push DIM. LED driver, 60W 24V DC, DALI/Push DIM dimmable.	 0,18
XM100/24I DIM Alimentatore LED, 100W 24V DC, dimmerabile DALI/Push DIM. LED driver, 100W 24V DC, DALI/Push DIM dimmable.	 0,27
XM200/24I DIM Alimentatore LED, 200W 24V DC, dimmerabile DALI/Push DIM. LED driver, 200W 24V DC, DALI/Push DIM dimmable.	 0,29
XM2038/46-3 Kit di alimentazione con rosone bianco, cavo di alimentazione a 3 poli di lunghezza 2,2m (86,6"). Power supply kit with white canopy, 3 pole power cable with lenght 2,2m (86,6").	 0,45
XM2038/46-5 Kit di alimentazione con rosone bianco, cavo di alimentazione a 5 poli di lunghezza 2,2m (86,6"). Power supply kit with white canopy, 5 pole power cable with lenght 2,2m (86,6").	 0,56
XM246-ALU CUT Taglio a richiesta di estruso di alluminio. Extruded aluminum cut on request.	

XM246-SCREEN CUT

Taglio a richiesta di schermo in policarbonato.
Polycarbonate screen cut on request.

DRIVER MATRIX XP246

CODE	KIT ALIMENTAZIONE INTERNA POWER SUPPLY KIT	KIT ALIMENTAZIONE DALI / PUSH DIM INTERNA DALI / PUSH DIM POWER SUPPLY KIT
XP246__050.0099	1x XM30/24I	1x XM35/24I DIM
XP246__100.0099	1x XM60/24I	1x XM60/24I DIM
XP246__200.0099	1x XM120/24I	1x XM100/24I DIM
XP246__300.0099	1x XM120/24I	1x XM200/24I DIM

DIFFUSERS

CODICE / CODE	L MM	L INCHES		kg
XM2033/34/45/46-600S	6000 x 30	236 ³ / ₈ " x 1 ¹ / ₈ "	Schermo diffusore in policarbonato estruso con finitura opalina, di lunghezza 6000mm (236,2"). Extruded polycarbonate diffuser with opaline finish, 6000mm (236,2") long.	0,47
XM2033/34/45/46-900S	9000 x 30	354 ³ / ₈ " x 1 ¹ / ₈ "	Schermo diffusore in policarbonato estruso con finitura opalina, di lunghezza 9000mm (354,3"). Extruded polycarbonate diffuser with opaline finish, 9000mm (354,3") long.	0,69
XM2033/34/45/46-1200S	12000 x 30	472 ⁴ / ₈ " x 1 ¹ / ₈ "	Schermo diffusore in policarbonato estruso con finitura opalina, di lunghezza 12000mm (472,4"). Extruded polycarbonate diffuser with opaline finish, 12000mm (472,4") long.	0,93
XM2033/34/45/46-600S PR	6000 x 30	236 ³ / ₈ " x 1 ¹ / ₈ "	Schermo diffusore in policarbonato estruso microprismatico, di lunghezza 6000mm (236,2"). Micro-prismatic extruded polycarbonate diffuser, 6000mm (236,2") long.	0,47
XM2033/34/45/46-900S PR	9000 x 30	354 ³ / ₈ " x 1 ¹ / ₈ "	Schermo diffusore in policarbonato estruso microprismatico, di lunghezza 9000mm (354,3"). Micro-prismatic extruded polycarbonate diffuser, 9000mm (354,3") long.	0,69
XM2033/34/45/46-1200S PR	12000 x 30	472 ⁴ / ₈ " x 1 ¹ / ₈ "	Schermo diffusore in policarbonato estruso microprismatico, di lunghezza 12000mm (472,4"). Micro-prismatic extruded polycarbonate diffuser, 12000mm (472,4") long.	0,93

L'Ufficio Tecnico Panzeri è disponibile a supporto della progettazione / Panzeri Technical Department is available to support the design



HARLEM XG251

Enzo Panzeri 2022

Patent pending

XG251_+_LED+YTC25101.K02

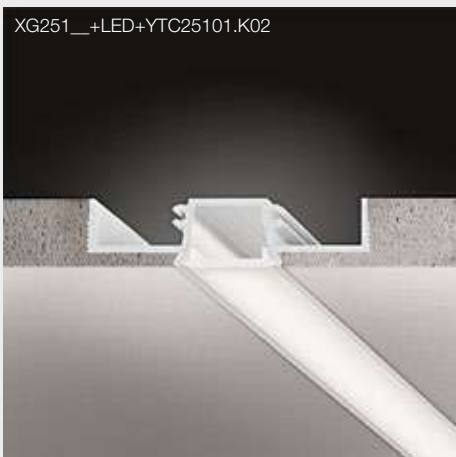

Sistema modulare di profili in alluminio estruso verniciato bianco, studiati per l'incasso in pannelli di cartongesso con effetto di scomparsa totale. La forma è pensata per non interferire con i telai di sostegno dei pannelli, garantendo la possibilità di posa in fila continua in qualunque punto della struttura. Le superfici forate su cui applicare il materiale per la rasatura assicurano una tenuta del gesso nel tempo; il risultato ottimale delle operazioni di rasatura, stuccatura e verniciatura è agevolato anche dalla presenza dello schermo monouso fornito di serie. Ogni modulo è completo di diffusore in policarbonato opalino.

Modular system of profiles in extruded aluminum in white finish, conceived for total recessed installation in drywall. The design allow not to interfere with the support frames of drywall panels, and grant free installation wherever required. The perforated surface of the profile enhances a durable application of plaster over time; moreover the disposable screen for installation ensures an optimal result in plastering and finishing the wall or ceiling. Supplied with additional opal polycarbonate diffuser.

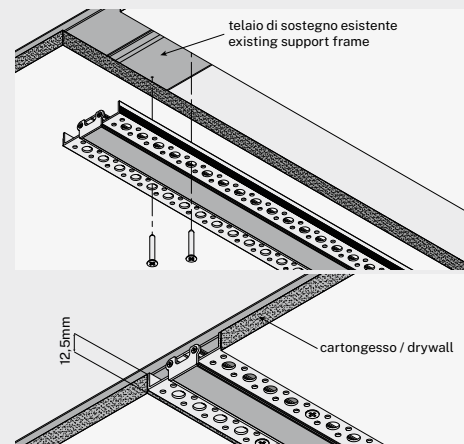
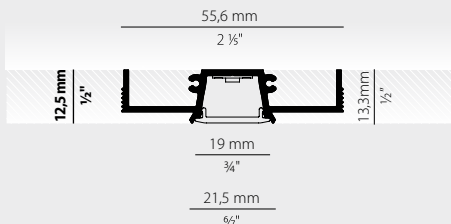

TRIMLESS PROFILE

	CODICE / CODE	L MM	L INCHES	MM	INCHES	kg
Fornito completo di schermo monouso e schermo diffusore opalino	XG25101.100.0099	1010	39 1/8"	1015 x 55	40" x 2 1/8"	
Supplied with disposable screen and opal diffuser	XG25101.200.0099	2010	79 1/8"	2015 x 55	79 3/8" x 2 1/8"	
	XG25101.300.0099	3010	118 3/8"	3015 x 55	118 4/8" x 2 1/8"	

LED MODULE

	CODICE / CODE	L MM	L INCHES	MM	INCHES	W/M	LM/M	NR. LED	LED	V
	YLR005.010.0410	5000	197"	42	1 7/8"	9,6W/m	1335lm/m	200/m	3000K Ra>90	24V DC
	YLR006.017.0410	5000	197"	42	1 7/8"	16,8W/m	2885lm/m	200/m	3000K Ra>90	24V DC

Altre temperature di colore disponibili a pag. 205 / Other colour temperatures available on page 205

Matrice di compatibilità LED / Profili pag. 146 / LED Profile Matrix page 146

CODICI COLORI DISPONIBILI / COLOUR CODES AVAILABLE

01 bianco
white

ACCESSORI / ACCESSORIES

YTC25101.K02

Coppia di testate di chiusura con viti.
Pair of end caps with screws.

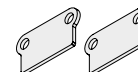

XM27000.301.0099

Kit di giunzione lineare.
Linear junction kit.

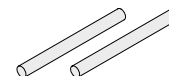

L'Ufficio Tecnico Panzeri è disponibile a supporto della progettazione / Panzeri Technical Department is available to support the design



KIPS ROUND XG271-XG272-XG273

XG271/272/273_+LED+XM27001.202.0099



Profilo in alluminio estruso ad incasso di piccole dimensioni, strip LED con guaina in silicone bianco opale da acquistare separatamente. Studiato per consentire l'installazione su pannelli in cartongesso a soffitto o parete. Disponibili moduli lineari e curvi, con molteplici possibilità di combinazione.

Small extruded aluminum profile recessed, with LED strip with opal white silicone sheath to order separately. Designed to allow installation on ceiling or wall plasterboard panels. Linear and curved modules are available with multiple combination possibilities.

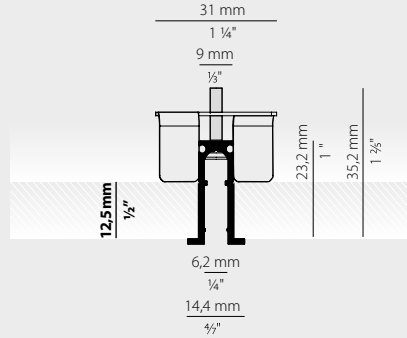

Electric options only with remote components	page 205
Dimming / Power supply	207-208
Technical information	210
Wiring diagram 2	210
Photometric data available at www.panzeri.it	

TRIM PROFILE



LED IP40 IP20 850°

CODICE / CODE	DEGREES	Ø MM	Ø INCHES	H MM	H INCHES	NR. ADVISED	MM	INCHES	kg
<input type="radio"/> XG27101.100.0099	45°	1033	40 5/8"	23,2	1"	2	Ø ext. 1029 / int. 1008	Ø ext. 40 1/2" / int. 39 5/8"	0,09
<input type="radio"/> XG27201.100.0099	90°	1033	40 5/8"	23,2	1"	2	Ø ext. 1029 / int. 1008	Ø ext. 40 1/2" / int. 39 5/8"	0,18
<input type="radio"/> XG27301.100.0099	180°	1033	40 5/8"	23,2	1"	3	Ø ext. 1029 / int. 1008	Ø ext. 40 1/2" / int. 39 5/8"	0,36

LED MODULE



CODICE / CODE	L MM	L INCHES	MM	INCHES	W	LM	LM/M	LED	V
 YLR101.011.0110	1000	39 3/8"	50	2"	10,6W	401lm	401lm/m	3000K Ra>80	24V DC
YLR102.011.0110	5000	197"	50	2"	10,6W/m	2005lm	401lm/m	3000K Ra>80	24V DC

Matrice di compatibilità LED / Profili pag. 146 / LED Profile Matrix page 146

CODICI COLORI DISPONIBILI / COLOUR CODES AVAILABLE

01 bianco
white

Esempio di composizione / Example of configuration:

- N.3 Kips Round XG27201.100.0099
- N.4 Kips XG27001.050.0099
- N.14 wing nut XM2701.201.0099
- N.6 kit linear junction XM27000.301.0099
- N.1 kit faston XM27000.401.0099
- N.2 strip LED YLR102.011.0110
- N.1 driver YDV.024.120.A01

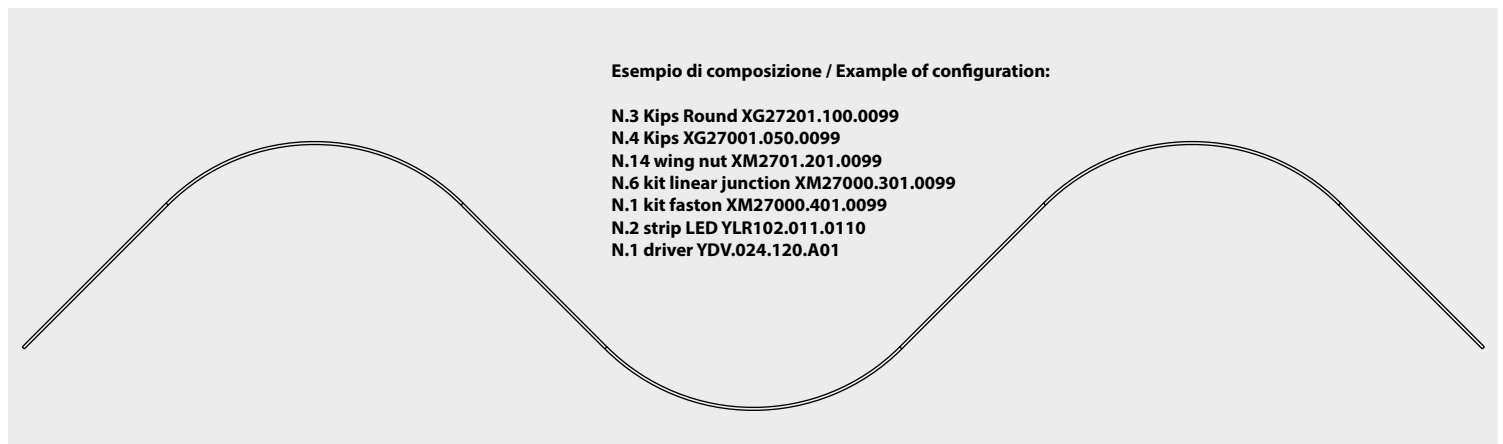



KIPS XG270

XG270_+LED+XM27001.202.0099



Profilo in alluminio estruso ad incasso di piccole dimensioni, strip LED con guaina in silicone bianco opale da acquistare separatamente. Studiato per consentire l'installazione su pannelli in cartongesso a soffitto o parete. Disponibili moduli lineari e curvi, con molteplici possibilità di combinazione.

Small extruded aluminum profile recessed, with LED strip with opal white silicone sheath to order separately. Designed to allow installation on ceiling or wall plasterboard panels. Linear and curved modules are available with multiple combination possibilities.

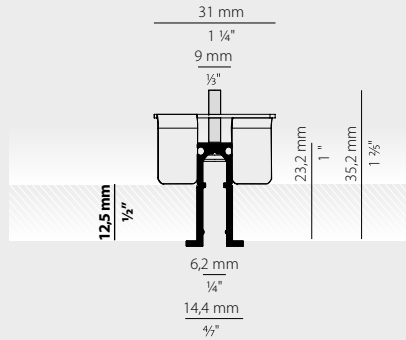

Electric options only with remote components	page 205
Dimming / Power supply	207-208
Technical information	210
Wiring diagram 2	210
Photometric data available at www.panzeri.it	

TRIM PROFILE

CODICE / CODE	L MM	L INCHES	NR. ADVISED	MM	INCHES	kg
XG27001.050.0099	500	19 3/8"	2	505 x 11	19 8/16" x 3/8"	0,11
XG27001.100.0099	1000	39 3/8"	2	1005 x 11	39 3/8" x 3/8"	0,23
XG27001.200.0099	2000	78 4/8"	3	2005 x 11	79" x 3/8"	0,45
XG27001.300.0099	3000	118 1/8"	4	3005 x 11	118 3/8" x 3/8"	0,68

LED MODULE

CODICE / CODE	L MM	L INCHES	MM	INCHES	W	LM	LM/M	LED	V
YLR101.011.0110	1000	39 3/8"	50	2"	10,6W	401lm	401lm/m	3000K Ra>80	24V DC
YLR102.011.0110	5000	197"	50	2"	10,6W/m	2005lm	401lm/m	3000K Ra>80	24V DC

Matrice di compatibilità LED / Profili pag. 146 / LED Profile Matrix page 146

CODICI COLORI DISPONIBILI / COLOUR CODES AVAILABLE

01 bianco
white

ACCESSORI / ACCESSORIES

XM27000.201.0099

Farfalla di fissaggio su cartongesso.
Drywall fixing bracket.

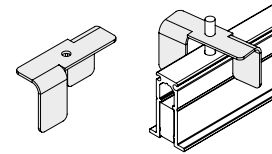

XM27001.202.0099

Coppia di testate di chiusura con viti.
Pair of end caps with screws.

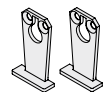

XM27000.301.0099

Kit di giunzione lineare.
Linear junction kit.

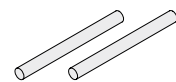

XM27000.401.0099

Kit di faston per il collegamento elettrico (10 pezzi).
Faston kit for electrical connection (10 pieces).

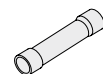

IN DISMISSIONE. PER INFORMAZIONI CONTATTARE IL CUSTOMER SERVICE / PHASING OUT. FOR INFORMATION CONTACT CUSTOMER SERVICE



MANHATTAN XG2044

XG2044-__TRACK+LED+XM2044-T



Sistema modulare LED in alluminio estruso verniciato bianco, da incasso a scomparsa totale (trimless) per applicazioni in cartongesso. Oltre alla possibilità di installazione a parete e soffitto, in posizione orizzontale e verticale, si presta in modo particolare per installazioni perimetrali. Grazie alla riflessione della luce interna, il profilo non necessita di un diffusore.

Trimless modular LED system in extruded aluminum painted white for use in false ceiling. Besides the possibility of horizontal or vertical installation on walls and ceilings, this system is particularly suitable for perimeter installation. Due to the reflection of the internal light, this profile does not require a diffuser.

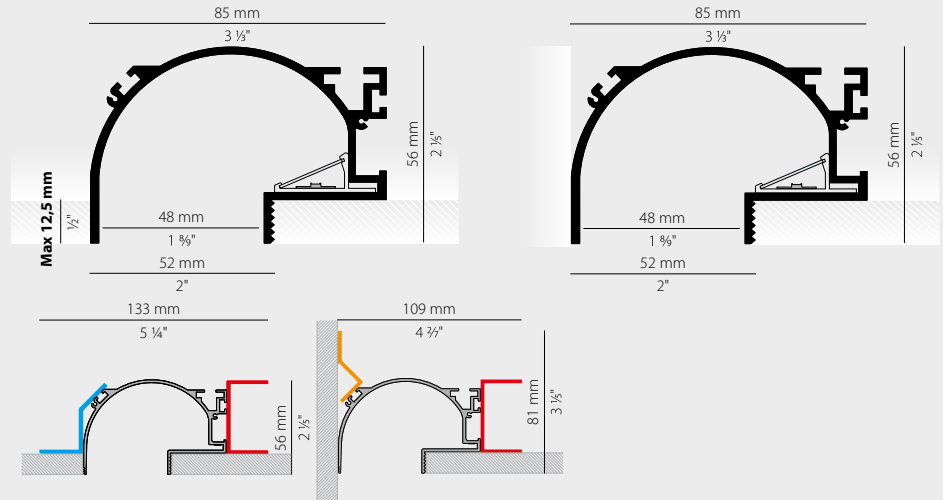

- Electric options only with remote components page 205
- Dimming / Power supply 207-208
- Technical information 210
- Wiring diagram 2-3 210-211
- UGR <19 depending on installation conditions
- Photometric data available at www.panzeri.it

TRIMLESS PROFILE

Fornito completo di supporto in alluminio per LED e schermo diffusore
Supplied with aluminium LED frame and diffuser

CODICE / CODE	L MM	L INCHES	NR. ADVISED	MM	INCHES	kg
XG2044-50TRACK	420	16 5/8"	2	425 x 58	16 3/4" x 2 3/8"	0,69
XG2044-100TRACK	920	36 1/4"	2	925 x 58	36 5/8" x 2 3/8"	1,38
XG2044-200TRACK	1920	75 3/8"	3	1925 x 58	75 5/8" x 2 3/8"	2,64
XG2044-300TRACK	2920	115"	4	2925 x 58	115 1/4" x 2 3/8"	4,13

LED MODULE



CODICE / CODE	L MM	L INCHES	MM	INCHES	W/M	LM/M	NR. LED	LED	V
YLR005.010.0410	5000	197"	50	2"	9,6W/m	1335lm/m	200/m	3000K Ra>80	24V DC
YLR006.017.0410	5000	197"	42	1 3/8"	16,8W/m	2285lm/m	200/m	3000K Ra>90	24V DC
YLR007.022.0410	5000	197"	42	1 3/8"	22W/m	2950lm/m	240/m	3000K Ra>90	24V DC

Altre temperature di colore disponibili a pag. 205 / Other colour temperatures available on page 205

Matrice di compatibilità LED / Profili pag. 146 / LED Profile Matrix page 146

**Eventuali tagli e saldature su rollina sono da quantificare a progetto.
Required cutting and welding on roll are to be calculated for each project.**

CODICI COLORI DISPONIBILI / COLOUR CODES AVAILABLE

- 01** bianco white
- 21** foglia oro (a richiesta) gold leaf (available on request)
- 23** foglia argento (a richiesta) silver leaf (available on request)
- 24** foglia rame (a richiesta) copper leaf (available on request)



ACCESSORI / ACCESSORIES

XM2044-U90 1

Elemento di collegamento per due linee di profili componibili con angolo di giunzione piano esterno di 90°, per installazione incassata a scomparsa.
Connection joint for two lines of modular profiles with external level junction 90°, for total built-in installation.

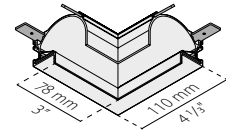
kg
0,31**XM2044-U90 2**

Elemento di collegamento per due linee di profili componibili con angolo di giunzione piano interno di 90°, per installazione incassata a scomparsa.
Connection joint for two lines of modular profiles with internal level junction 90°, for total built-in installation.

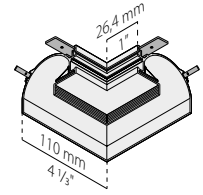

0,27

XM2044-ANG 3

Elemento di collegamento per due linee di profili componibili con angolo di giunzione perpendicolare interno di 90°, per installazione incassata a scomparsa.
Connection joint for two lines of modular profiles with internal perpendicular junction 90°, for total built-in installation.

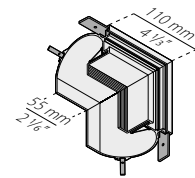

0,35

XM2044-ANG 4

Elemento di collegamento per due linee di profili componibili con angolo di giunzione perpendicolare esterno di 90°, per installazione incassata a scomparsa.
Connection joint for two lines of modular profiles with external perpendicular junction 90°, for total built-in installation.

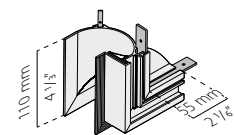

0,31

XM2044-U

Kit di giunzione lineare.
Linear junction kit.

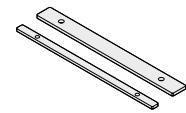

0,45

XM2044-TA

Vano per alimentazione con viti da fissare sulle giunzioni.
Power compartment with screws for installation on junctions.

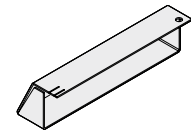

0,11

XM2044-T

Coppia di testate di chiusura con viti.
Pair of end caps with screws.

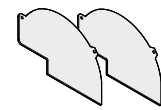

0,03

XM2044-F

Kit di staffe di fissaggio su cartongesso.
Drywall fixing bracket kit.



0,06

XM2044-FP

Kit di staffe di fissaggio filo parete.
Flush wall fixing bracket kit.

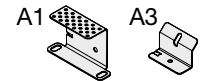

0,05

XM2044-P

Piastrina per appendimento.
Plate for hanging.

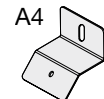

0,02

XM2044-CUT

Taglio lineare per moduli dritti.
Linear cut for straight modules.

In considerazione della particolare forma del prodotto e delle eventuali sfumature di colore lungo e tra gli elementi del sistema XG2044, si evidenzia che è cura dell'installatore abbinare i pezzi adiacenti in modo da ottenere più uniformità possibile di colore. Nessuna responsabilità è imputabile al produttore.

Given the particular shape of the product and the eventual colour shades along and between the elements of system XG2044, please note that the installer has the responsibility to match the adjacent pieces so as to obtain the best colour uniformity. The manufacturer does not accept any liability.

L'Ufficio Tecnico Panzeri è disponibile a supporto della progettazione / Panzeri Technical Department is available to support the design

XM2044-U
Giunzione lineare
Linear junction

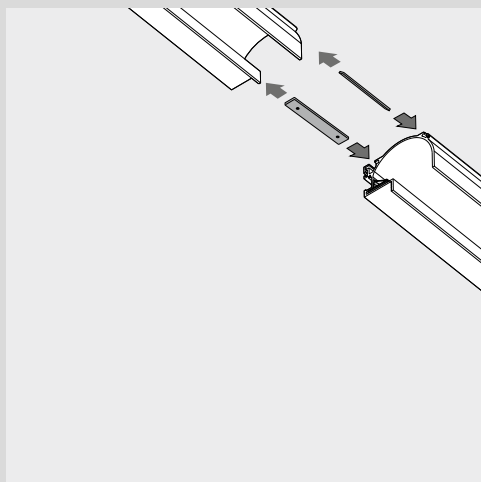

XM2044-U90 1
Angolo 1 piano 90° parete-parete / soffitto-soffitto misure esterne 110x110mm
Angle 1 horizontal 90° wall-wall / ceiling-ceiling, external measurements 110x110mm

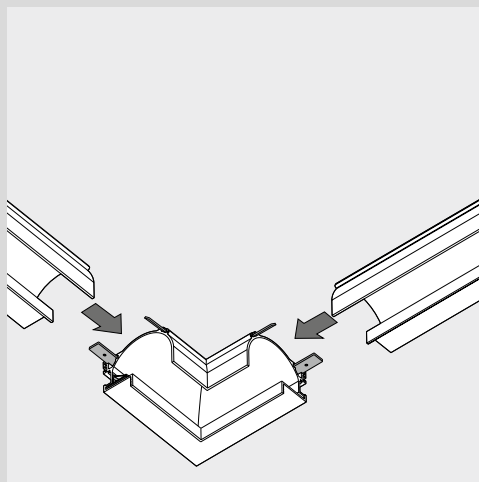

XM2044-U90 2
Angolo 2 piano 90° parete-parete / soffitto-soffitto misure esterne 110x110mm
Angle 2 horizontal 90° wall-wall / ceiling-ceiling, external measurements 110x110mm

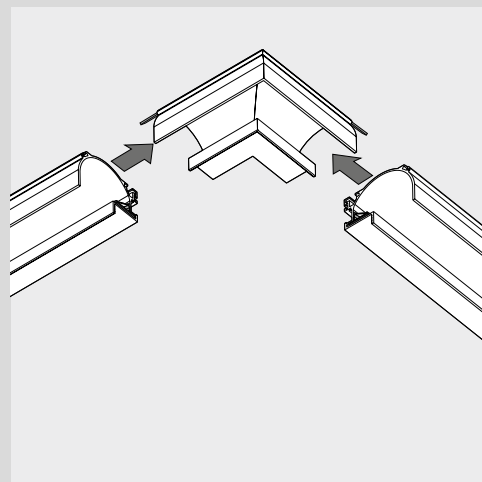

XM2044-ANG 3
Angolo 3 verticale 90° parete-soffitto/parete-parete misure esterne 110x110mm
Angle 3 vertical 90° wall-ceiling / wall-wall, external measurements 110x110mm

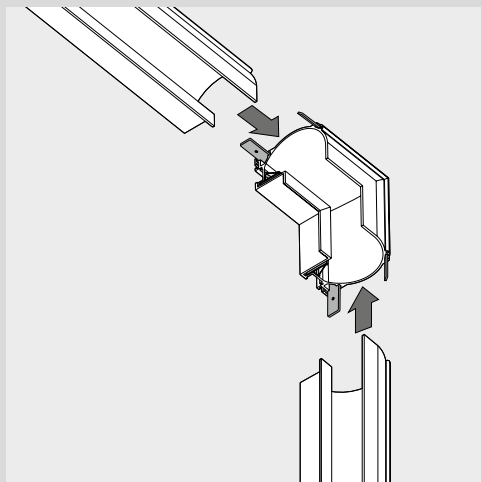

XM2044-ANG 4
Angolo 4 orizzontale 90° parete-parete misure esterne 110x110mm
Angle 4 horizontal 90° wall-wall, external measurements 110x110mm

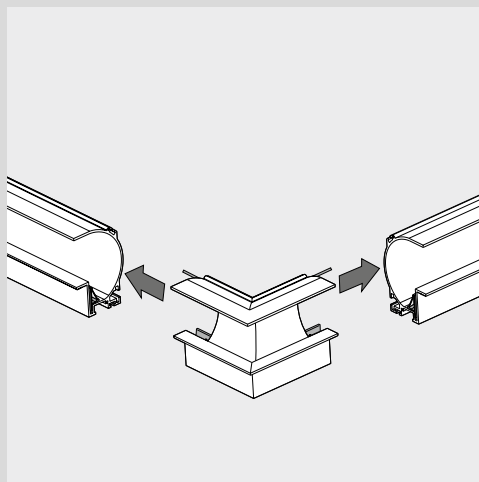

XM2044-TA
Vano alimentazione (opzionale) con viti da fissare sulla giunzione
Power compartment (optional) with screws for installation on the junction

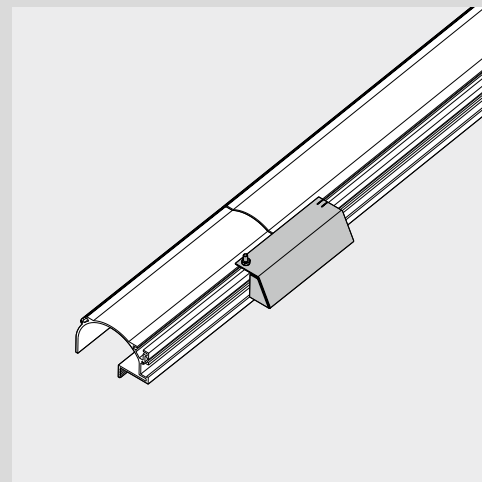

ESEMPI DI INSTALLAZIONE / INSTALLATION EXAMPLE

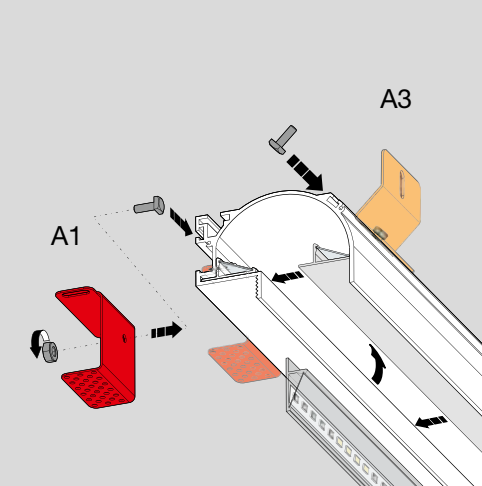
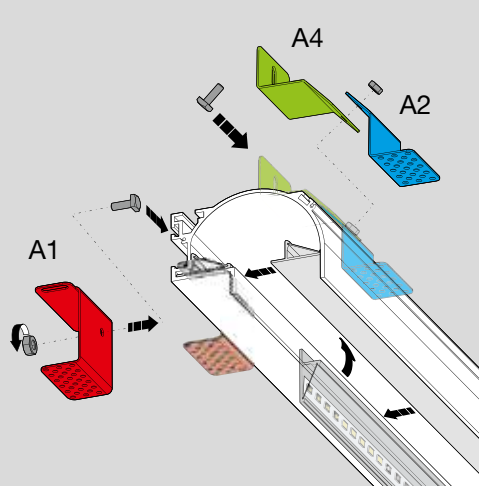
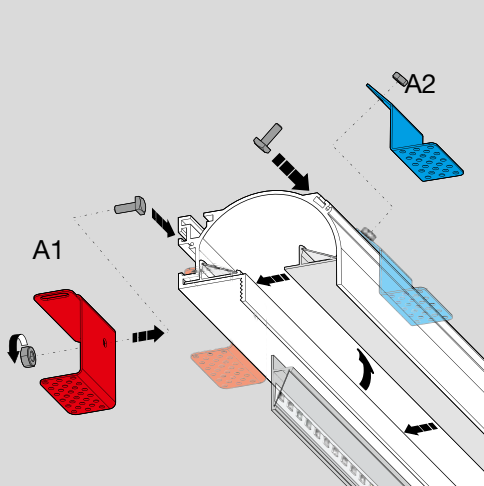



BROADWAY XP248

XP248__+LED+XM24801.202.0099



Profilo da parete/soffitto, sezionabile in alluminio estruso completo di diffusore in policarbonato.

Wall/ceiling cuttable profile in extruded aluminium supplied with polycarbonate diffuser.

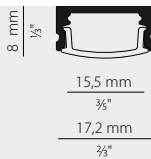

Electric options only with remote components	page 205
Dimming / Power supply	207-208
Technical information	210
Wiring diagram 2	210
Photometric data available at www.panzeri.it	

CEILING / WALL PROFILE



	CODICE / CODE	L MM	L INCHES	kg
Fornito completo di schermo diffusore Supplied with diffuser	XP24801.200.0099	2000	78 1/2"	0,27

LED MODULE



	CODICE / CODE	L MM	L INCHES	MM	INCHES	W/M	LM/M	NR. LED	LED	V
	YLR005.010.0410	5000	197"	50	2"	9,6W/m	1335lm/m	200/m	3000K Ra>80	24V DC
	YLR006.017.0410	5000	197"	42	1 3/8"	16,8W/m	2285lm/m	200/m	3000K Ra>90	24V DC

Altre temperature di colore disponibili a pag. 205 / Other colour temperatures available on page 205

Matrice di compatibilità LED / Profili pag. 146 / LED Profile Matrix page 146

CODICI COLORI DISPONIBILI / COLOUR CODES AVAILABLE

01 bianco
white

ACCESSORI / ACCESSORIES

XM24801.202.0099
Coppia di testate di chiusura.
Pair of end caps.

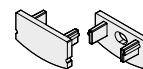

XM24800.201.0099
Coppia di clip di fissaggio.
Pair of fixing clips.

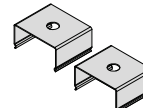



NOOK XP250

XP250_+LED+XM25001.202.0099



Profilo per installazione angolare, pensato per il montaggio in corrispondenza degli spigoli formati da due pareti o da parete e soffitto, oppure per applicazione sotto mensole e pensili. Modulo sezionabile, in alluminio estruso di lunghezza 2000mm completo di diffusore in policarbonato.

Profile for corner perimetral installation, designed to be installed at the edge of two walls or one wall and the ceiling, or alternatively as an application underneath shelves and cabinets. The profile can be cut on the project site, and is made of extruded aluminum 2000mm in length supplied with a opal polycarbonate diffuser.

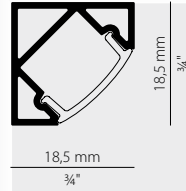

Electric options only with remote components	page 205
Dimming / Power supply	207-208
Technical information	210
Wiring diagram 2	210
Photometric data available at www.panzeri.it	

CEILING /WALL PROFILE

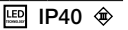

	CODICE / CODE	L MM	L INCHES	kg
Fornito completo di schermo diffusore Supplied with diffuser	XP25001.200.0099	2000	78 3/4"	0,46

LED MODULE



	CODICE / CODE	L MM	L INCHES	MM	INCHES	W/M	LM/M	NR. LED	LED	V
	YLR005.010.0410	5000	197"	50	2"	9,6W/m	1335lm/m	200/m	3000K Ra>80	24V DC
	YLR006.017.0410	5000	197"	42	1 1/2"	16,8W/m	2285lm/m	200/m	3000K Ra>90	24V DC

Altre temperature di colore disponibili a pag. 205 / Other colour temperatures available on page 205

Matrice di compatibilità LED / Profili pag. 146 / LED Profile Matrix page 146

CODICI COLORI DISPONIBILI / COLOUR CODES AVAILABLE

01 bianco
white

ACCESSORI / ACCESSORIES

kg

XM25001.202.0099

Coppia di testate di chiusura.
Pair of end caps.



XM25000.201.0099

Coppia di clip di fissaggio.
Pair of fixing clips.



VADEMECUM PROFILI / PROFILE HANDBOOK

GIUNZIONI DISPONIBILI / AVAILABLE JOINTS						
MODELLO / MODEL	GIUNZIONE / JOINT					
	LINEARE/LINEAR	90°	T	X	ANG. VERTICALI/VERTICAL ANGLE	SPECIALI / SPECIAL
XG2033	•	•	•	•	•	•
XP2033	•	•				
XG2034	•	•			•	
XG2044	•	•				
XG2045	•	•			•	
XP246	•					
XG247	•	•				
XP248	•					
XG249	•					
XP250	•					
XG251	•					
XG270	•					
XG271 / XG272 / XG273	•					

MATRICE LED/PROFILO / LED PROFILE MATRIX								
MODELLO / MODEL	XM005	XM006	YLR007	YLR006	YLR005	YLR008	YLR101	YLR102
XG2033		•	•	•	•	•		
XP2033		•	•	•	•	•		
XG2034		•	•	•	•	•		
XG2044			•	•	•	•		
XG2045		•	•	•	•	•		
XP246		•	•	•	•	•		
XG247	•							
XP248				•	•			
XG249				•	•			
XP250				•	•			
XG251				•	•			
XG270							•	•
XG271 / XG272 / XG273							•	•

INFORMAZIONI LED / LED SPECIFICATION					
MODELLO / MODEL	POTENZA (W/m) POWER (W/m)	FLUSSO LUMINOSO (lm/m) LUMINOUS FLUX (lm/m)	DIVISIBILE OGNI (mm) CUT EVERY (mm)	LED/m	LUNGHEZZA (mm) / LENGHT (mm)
XM005	17,2	2280	62,5	128	500 ₁₂₅
XM006	17,2	2280	62,5	128	500 ₁₂₅
YLR005	9,6	1100 - 1220 - 1300	5	200	5000
YLR006	16,8	1900 - 2070 - 2220	5	200	5000
YLR007	22	2490 - 2700 - 2750	4,2	240	5000
YLR008	9,6	1100 - 1220	5	200	5000
YLR101	10,6	401	50		1000
YLR102	10,6	401	50		5000

DIMENSIONI E POSSIBILITÀ DI TAGLIO / DIMENSIONS AND CUT CONFIGURATION					
MODELLO / MODEL	DIMENSIONI STANDARD / STANDARD DIMENSIONS				TAGLIABILE / CUTTABLE
XG2033	510	1010	2010	3010	•
XP2033	525	1025	2025	3025	•
XG2034	510	1010	2010	3010	•
XG2044	420	920	1920	2920	•
XG2045	510	1010	2010	3010	•
XP246	515	1015	2015	3015	•
XG247	510	1010	2010	3010	•
XP248	2000				•
XG249	2000				•
XP250	2000				•
XG251	1010	2010	3010		•
XG270	500	1000	2000	3000	•

ANGOLI / ANGLE U90-1/U90-2

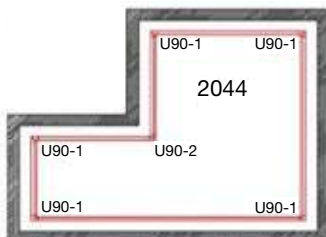

La luce nella configurazione standard è rivolta principalmente verso la parete

With standard configuration light is mainly oriented towards the wall

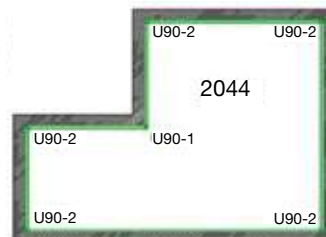

La luce nella configurazione standard è rivolta principalmente verso il centro della stanza

With standard configuration light is mainly oriented towards the center of room

PROIETTORI / SPOTLIGHT

171	432 WAYS
150	ASTORIA 3
149	ASTORIA 5
148	ASTORIA 8
152	ASTORIA IN
151	ASTORIA LINE
154	ASTORIA OUT
151	ASTORIA SPOT
172	BELLA
173	MURANE'
161	QUEENS
160	QUEENS 10
159	QUEENS 20
158	QUEENS 25
157	QUEENS 45
174	RENDEZ-VOUS
175	SCENT
165	SOHO 5
164	SOHO 10
163	SOHO 20
167	SOHO IN
166	SOHO LINE
169	SOHO OUT
180	STREET 3
179	STREET 5
178	STREET 8
184	STREET IN
181	STREET LINE
186	STREET OUT
181	STREET SPOT
177	TO-BE



ASTORIA 8



Proiettore orientabile in pressofusione di alluminio con LED ad alta efficienza e adattatore integrato, per binario elettrificato a bassissima tensione 48V. Completo di cilindro antiabbagliamento e lente con fascio medio in materiale termoplastico. Disponibile in versione 2700K e 3000K, in finitura bianco, nero, ottone satinato e bronzo, con braccio e coperchio posteriore in colore nero.

Die-cast aluminium adjustable spotlight with high efficiency LED and integrated adapter for 48V low voltage electrified track. Complete with anti-glare snoot and thermoplastic medium-beam lens. Available in 2700K and 3000K version, in white, black, matte brass and bronze finishes, with black arm and back cover.

CODICE CODE	FONTI LUMINOSE LIGHT SOURCES	kg
B43401.008.1719	Potenza assorbita apparecchio / Luminaire power consumption 15W	0,23
B43402.008.1719	Flusso luminoso apparecchio / Luminaire luminous flux 1100lm	
B43417.008.1719	2700K Ra>90 24° 48V DC dimmable (DALI)	
B43419.008.1719	IP20	
B43401.008.2519	Potenza assorbita apparecchio / Luminaire power consumption 15W	0,23
B43402.008.2519	Flusso luminoso apparecchio / Luminaire luminous flux 1100lm	
B43417.008.2519	3000K Ra>90 24° 48V DC dimmable (DALI)	
B43419.008.2519	IP20	

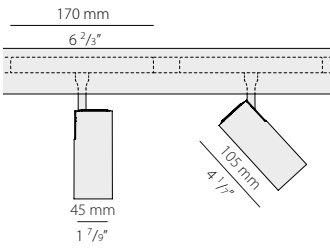

	STANDARD	Lente per fascio medio. Flood lens.	
	YLN43400.15	Lente per fascio stretto. Spot lens.	0,01
	YLN43400.35	Lente per fascio medio. Flood lens.	0,01

Astoria 8 con griglia anti-abbagliamento in colore nero disponibile a richiesta.
Astoria 8 with anti-glare grid in black colour available on demand.



Fotometrie disponibili www.panzeri.it / Photometric data available at www.panzeri.it

CODICI COLORI DISPONIBILI / COLOUR CODES AVAILABLE

01 bianco white **02** nero black **17** bronzo bronze **19** ottone satinato matte brass





ASTORIA 5



Proiettore orientabile in pressofusione di alluminio con LED ad alta efficienza e adattatore integrato, per binario elettrificato a bassissima tensione 48V. Completo di cilindro antiabbagliamento e lente con fascio medio in materiale termoplastico. Disponibile in versione 2700K e 3000K, in finitura bianco, nero, ottone satinato e bronzo, con braccio e coperchio posteriore in colore nero.

Die-cast aluminium adjustable spotlight with high efficiency LED and integrated adapter for 48V low voltage electrified track. Complete with anti-glare snoot and thermoplastic medium-beam lens. Available in 2700K and 3000K version, in white, black, matte brass and bronze finishes, with black arm and back cover.

	CODICE CODE	FONTI LUMINOSE LIGHT SOURCES	kg
	B43201.005.1719	Potenza assorbita apparecchio / Luminaire power consumption 8,4W	0,16
	B43202.005.1719	Flusso luminoso apparecchio / Luminaire luminous flux 590lm	
	B43217.005.1719	2700K Ra>90 24° 48V DC dimmable (DALI)	
	B43219.005.1719	IP20	
	B43201.005.2519	Potenza assorbita apparecchio / Luminaire power consumption 8,4W	0,16
	B43202.005.2519	Flusso luminoso apparecchio / Luminaire luminous flux 590lm	
	B43217.005.2519	3000K Ra>90 24° 48V DC dimmable (DALI)	
	B43219.005.2519	IP20	

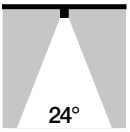

STANDARD

Lente per fascio medio.
Flood lens.

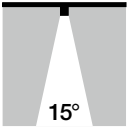

YLN43200.15

Lente per fascio stretto.
Spot lens.

0,01

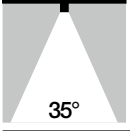

YLN43200.35

Lente per fascio medio.
Flood lens.

0,01

Astoria 5 con griglia anti-abbagliamento in colore nero disponibile a richiesta.
Astoria 5 with anti-glare grid in black colour available on demand.



Fotometrie disponibili www.panzeri.it / Photometric data available at www.panzeri.it

CODICI COLORI DISPONIBILI / COLOUR CODES AVAILABLE

- 01** bianco
white
- 02** nero
black
- 17** bronzo
bronze
- 19** ottone satinato
matte brass





ASTORIA 3



Proiettore orientabile in pressofusione di alluminio con LED ad alta efficienza e adattatore integrato, per binario elettrificato a bassissima tensione 48V. Completo di cilindro antiabbagliamento e lente con fascio medio in materiale termoplastico. Disponibile in versione 2700K e 3000K, in finitura bianco, nero, ottone satinato, bronzo e titanio, con braccio e coperchio posteriore in colore nero.

Die-cast aluminium adjustable spotlight with high efficiency LED and integrated adapter for 48V low voltage electrified track. Complete with anti-glare snoot and thermoplastic medium-beam lens. Available in 2700K and 3000K version, in white, black, matte brass, bronze and titanium finishes, with black arm and back cover.

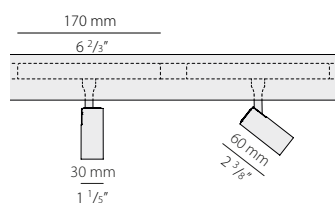

CODICE CODE	FONTI LUMINOSE LIGHT SOURCES	kg
B43301.003.1719	Potenza assorbita apparecchio / Luminaire power consumption 7,2W	0,13
B43302.003.1719	Flusso luminoso apparecchio / Luminaire luminous flux 447lm	
B43317.003.1719	2700K Ra>90 24° 48V DC dimmable (DALI)	
B43319.003.1719	IP20	
B43301.003.2519	Potenza assorbita apparecchio / Luminaire power consumption 7,2W	0,13
B43302.003.2519	Flusso luminoso apparecchio / Luminaire luminous flux 447lm	
B43317.003.2519	3000K Ra>90 24° 48V DC dimmable (DALI)	
B43319.003.2519	IP20	

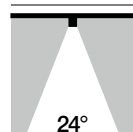

STANDARD Lente per fascio medio. Flood lens.

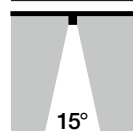

YLN43300.15 Lente per fascio stretto. Spot lens. 0,01

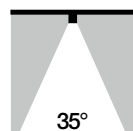

YLN43300.35 Lente per fascio medio. Flood lens. 0,01



Astoria 3 con griglia anti-abbagliamento in colore nero disponibile a richiesta. Astoria 3 with anti-glare grid in black colour available on demand.

Fotometrie disponibili www.panzeri.it / Photometric data available at www.panzeri.it

CODICI COLORI DISPONIBILI / COLOUR CODES AVAILABLE

- 01** bianco white
- 02** nero black
- 17** bronzo bronze
- 19** ottone satinato matte brass





ASTORIA LINE



Modulo lineare a luce diffusa per binario elettrificato a bassissima tensione 48V per applicazioni soffitto/parete, sospensione e incasso, con corpo in alluminio in colore nero e schermo in policarbonato estruso opale. Possibilità di dimmerazione tramite protocollo DALI.

Linear LED module for 48V low voltage electrified track, for ceiling/wall, suspended or recessed applications. Black aluminium body, opal diffuser made in extruded polycarbonate. Possibility of dimming with DALI protocol.

	CODICE CODE	FONTI LUMINOSE LIGHT SOURCES	kg
	B43102.060.0519	Potenza assorbita apparecchio / Luminaire power consumption 11,4W Flusso luminoso apparecchio / Luminaire luminous flux 990lm 2700K Ra>90 48V DC dimmable (DALI) IP20	0,33
	B43102.060.0419	Potenza assorbita apparecchio / Luminaire power consumption 11,4W Flusso luminoso apparecchio / Luminaire luminous flux 990lm 3000K Ra>90 48V DC dimmable (DALI) IP20	0,33

Fotometrie disponibili www.panzeri.it / Photometric data available at www.panzeri.it

CODICI COLORI DISPONIBILI / COLOUR CODES AVAILABLE

02 nero
black

ASTORIA SPOT



Modulo di luce lineare per binario elettrificato a bassissima tensione 48V per applicazioni soffitto/parete, sospensione e incasso, disponibile in due diverse lunghezze. Corpo in alluminio in colore nero, lenti con fascio 30° in policarbonato e copertura in materiale plastico. Possibilità di dimmerazione tramite protocollo DALI.

Linear LED module for 48V low voltage electrified track, for ceiling/wall, suspended or recessed applications, available in two different lengths. Black aluminium body, 30° beam polycarbonate lens and plastic cover. Possibility of dimming with DALI protocol.

	CODICE CODE	FONTI LUMINOSE LIGHT SOURCES	kg
	B43002.030.1719	Potenza assorbita apparecchio / Luminaire power consumption 5,7W Flusso luminoso apparecchio / Luminaire luminous flux 414lm 2700K Ra>90 30° 48V DC dimmable (DALI) IP20	0,22
	B43002.030.2519	Potenza assorbita apparecchio / Luminaire power consumption 5,7W Flusso luminoso apparecchio / Luminaire luminous flux 414lm 3000K Ra>90 30° 48V DC dimmable (DALI) IP20	0,22
	B43002.060.1719	Potenza assorbita apparecchio / Luminaire power consumption 10,6W Flusso luminoso apparecchio / Luminaire luminous flux 828lm 2700K Ra>90 30° 48V DC dimmable (DALI) IP20	0,37
	B43002.060.2519	Potenza assorbita apparecchio / Luminaire power consumption 10,6W Flusso luminoso apparecchio / Luminaire luminous flux 828lm 3000K Ra>90 30° 48V DC dimmable (DALI) IP20	0,37

Fotometrie disponibili www.panzeri.it / Photometric data available at www.panzeri.it

CODICI COLORI DISPONIBILI / COLOUR CODES AVAILABLE

02 nero
black

ASTORIA IN



Sistema di binari a bassissima tensione 48V per applicazioni ad incasso. Binario a sezione rettangolare in alluminio estruso anodizzato nero, predisposto per alloggiare i proiettori e i moduli luminosi provvisti di adattatore 48V. Possibilità di regolazione DALI. Disponibile un'ampia varietà di accessori e giunti di collegamento.

System of 48V low voltage electrified tracks for recessed applications. Square-shaped track made of black anodised extruded aluminium, suitable to host spotlights and linear light modules equipped with 48V adapters. Possibility of DALI dimming. Wide range of available accessories and joints.

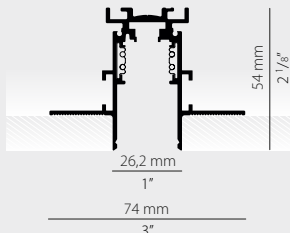

TRIMLESS RECESSED ELECTRIFIED TRACK 48V DC

IP20 850°

CODICE / CODE	L MM	L INCHES	kg
9500-2/B-ST5-E	2000	78 7/8"	2,50

CODICI COLORI DISPONIBILI / COLOUR CODES AVAILABLE

B nero
black

ACCESSORI / ACCESSORIES

S-9500-L/B-2000

Copertura di protezione per installazione binario elettrificato a incasso.
Protective cover for recessed electrified track installation.

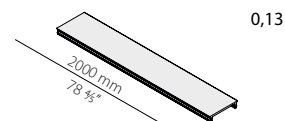

S-9500/LE-B-3000

Copertura estetica per binario elettrificato 48V DC.
Aesthetic cover for 48V DC electrified track.

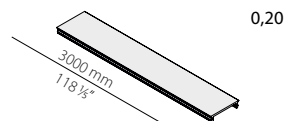

9501-S/B-E

Alimentazione di testa per binario elettrificato 48V DC DALI.
Head power supply for 48V DC DALI electrified track.

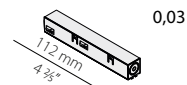

S-9500/314-B

Giunzione lineare senza contatti per binario elettrificato a incasso 48V DC.

N. 3 PEZZI PER OGNI GIUNZIONE

Linear mechanical junction for recessed electrified 48V DC track.

3 PIECES FOR EACH JUNCTION.

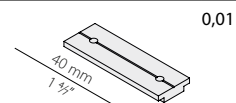

9503-S/B-E

Giunto lineare elettrificato per binario 48V DC DALI.
Linear electrified joint for 48V DC DALI track.

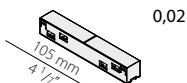

S-9511/B-ST5

Giunzione meccanica a "L" per binario elettrificato 48V DC a incasso senza bordo.

Acquistare min. n.4 S-9500/314-B

Mechanical "L" joint for 48V DC recessed trimless electrified track.

Purchase min. no.4 S-9500/314-B

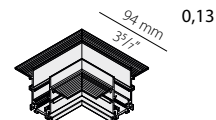

9511/B-E

Giunto elettrificato a "L" per binario 48V DC DALI.
Electrified "L" joint for 48V DC DALI track.

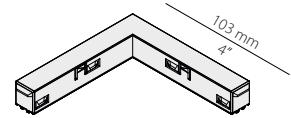

0,06

S-9511-I/B-ST5

Giunzione meccanica a "L" interna parete/soffitto per binario elettrificato 48V DC a incasso senza bordo.

Acquistare min. n.4 S-9500/314-B

Internal wall/ceiling "L" joint for 48V DC recessed trimless electrified track.

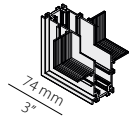
Purchase min. no.4 S-9500/314-B

0,12

9518-S/B-E

Giunto elettrificato flessibile per binario 48V DC DALI.
Flexible electrified joint for 48V DC DALI track.

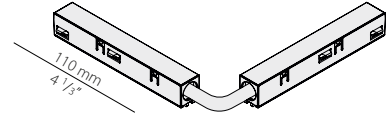

0,07

9504/ST2-B

Testata di chiusura per binario elettrificato 48V DC, senza foro.
End cap for 48V DC electrified track, without power supply hole.



0,02

9504/ST2-B-F

Testata di chiusura per binario elettrificato 48V DC, con foro.
End cap for 48V DC electrified track, with power supply hole.



0,02

S-9000-P4

Kit sospensione per binario ad incasso con tige rigida di lunghezza 1000mm (39,4").
Suspension kit with rigid tige 1000mm (39,4") long for recessed track.

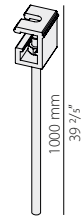

0,20

S-9000/118

Clip per fissaggio rapido con tenditore per tige rigida di sospensione.
Clip for quick fastening with turnbuckle for rigid suspension tige.



0,01

YBE41002.DV1

Alimentatore integrato per binario elettrificato 48V DC, 100W, on/off, con n. 2 cavi aggiuntivi per cablaggio passante DALI.
Integrated 100W on/off power supply for electrified 48V track, with 2 additional cables for DALI feed-through wiring.

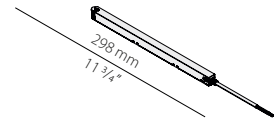

0,15

YRS.B048.A16

Dispositivo ripetitore per optoisolare il bus data, per binario elettrificato 48V DC DALI.

ACCESSORIO OBBLIGATORIO

Repeater device for opto-isolating the data bus, for 48V DC DALI electrified track.

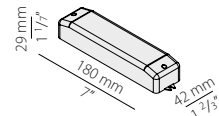
MANDATORY ACCESSORY**YDV.048.075.A01**

Alimentatore LED, 75W 48V DC, on/off.
LED driver, 75W 48V DC, on/off.

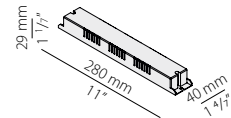

0,23

YDV.048.150.A01

Alimentatore LED, 150W 48V DC, on/off.
LED driver, 150W 48V DC, on/off.

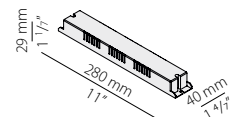

0,25

XM9500-CUT

Taglio lineare per binario Astoria.
Linear cut for Astoria track.

ASTORIA OUT



Sistema di binari a bassissima tensione 48V per installazioni a soffitto/parete o sospensione. Binario a sezione rettangolare in alluminio estruso anodizzato nero, predisposto per alloggiare i proiettori e i moduli luminosi provvisti di adattatore 48V. Parte esterna disponibile in finitura ottone e bronzo. Possibilità di regolazione DALI. Disponibile un'ampia varietà di accessori e giunti di collegamento.

System of 48V low voltage electrified tracks for ceiling/wall or suspended applications. Square-shaped track made of black anodised extruded aluminium, suitable to host spotlights and linear light modules equipped with 48V adapters. Outer part available in brass and bronze finish. Possibility of DALI dimming. Wide range of available accessories and joints.

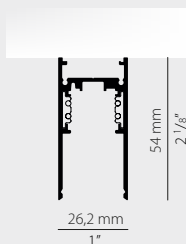

ELECTRIFIED TRACK 48V DC

IP20 850°

CODICE / CODE	L MM	L INCHES	kg
9500-2/B-ST2-E	2000mm	78 4/5"	2,05

CODICI COLORI DISPONIBILI / COLOUR CODES AVAILABLE

B nero
black

ELECTRIFIED TRACK 48V DC

IP20 850°

CODICE / CODE	L MM	L INCHES	kg
B41117.200	2000mm	78 4/5"	2,05
B41119.200	2000mm	78 4/5"	2,05

CODICI COLORI DISPONIBILI / COLOUR CODES AVAILABLE

17 bronzo
bronzes

19 ottone
brass

ACCESSORI / ACCESSORIES

S-9500/LE-B-3000

Copertura estetica di lunghezza 3000mm (118,1") per binario elettrificato 48V DC.
Aesthetic cover for 48V DC electrified track, length 3000mm (118.1")

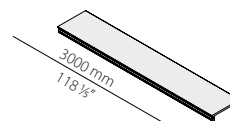

kg
0,20

9501-S/B-E

Alimentazione di testa per binario elettrificato 48V DC DALI.
Head power supply for 48V DC DALI electrified track.

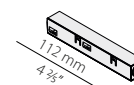

0,03

S-9500/323-SV

Giunzione lineare per binario elettrificato a sospensione o plafone.
Linear junction for suspended or ceiling-mounted electrified track.

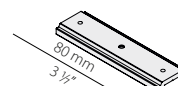

0,01

9503-S/B-E

Giunto lineare elettrificato per binario 48V DC DALI.
Linear electrified joint for 48V DC DALI track.

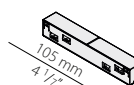

0,02

S-9511/B-ST2

Giunzione a "L" per binario elettrificato 48V DC a sospensione o plafone.
"L" junction for 48V DC suspended or ceiling-mounted electrified track.

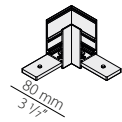

0,13

9511/B-E

Giunto elettrificato a "L" per binario 48V DC DALI.
Electrified "L" joint for 48V DC DALI track.

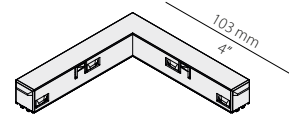

0,06

9518-S/B-E

Giunto elettrificato flessibile per binario 48V DC DALI.
Flexible electrified joint for 48V DC DALI track.

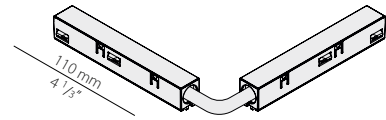

0,07

9504/ST2-B

Testata di chiusura per binario elettrificato 48V DC, senza foro.
End cap for 48V DC electrified track, without power supply hole.



0,02

9504/ST2-B-F

Testata di chiusura per binario elettrificato 48V DC, con foro.
End cap for 48V DC electrified track, with power supply hole.



0,02

YBE41117.TC**YBE41119.TC**

Testata di chiusura per binario elettrificato 48V DC, senza foro, in finitura bronzo o ottone.
End cap for 48V DC electrified track, without power supply hole, in bronze or brass finish.



0,02

YBE41117.TCF**YBE41119.TCF**

Testata di chiusura per binario elettrificato 48V DC, con foro, in finitura bronzo o ottone.
End cap for 48V DC electrified track, with power supply hole, in bronze or brass finish.



0,02

S-9500/114-B

Kit per attacco a soffitto per binario elettrificato 48V DC.
Ceiling mounting kit for 48V DC electrified track.



0,01

9500-KIT1-3

Kit sospensione per estremità, con fune di acciaio di lunghezza 3000mm (118,1"), per binario elettrificato.
End suspension kit, with 3000mm (118.1") long steel wire, for electrified track.

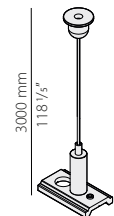

0,07

9500-KIT2-3

Kit fissaggio e giunzione per binario elettrificato a sospensione, con fune di acciaio di lunghezza 3000mm (118,1").
Fixing and junction kit, with 3000mm (118.1") long steel wire, for suspended electrified track.

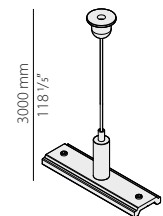

0,08

9500/P-100E-B-SP-N

Kit di alimentazione con rosone per binario elettrificato a sospensione, con driver 100W/48V e testata di alimentazione.
Power supply kit with canopy for electrified suspended track, with 100W/48V driver and power supply head.

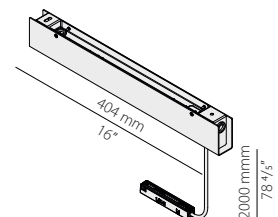

1,5

9500/P-100E-B-C1-N

Kit di alimentazione con rosone per binario elettrificato a plafone, con driver 100W/48V e testata di alimentazione.
Power supply kit with canopy for ceiling-mounted electrified track, with 100W/48V driver and power supply head.

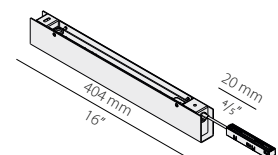

1,5

ACCESSORI / ACCESSORIES

kg

YBE41002.DV1

Alimentatore integrato per binario elettrificato 48V DC, 100W, on/off, con n. 2 cavi aggiuntivi per cablaggio passante DALI.
Integrated 100W on/off power supply for electrified 48V track, with 2 additional cables for DALI feed-through wiring.

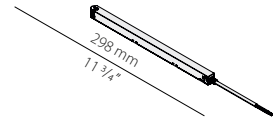

0,15

YRS.B048.A16

Dispositivo ripetitore per optoisolare il bus data, per binario elettrificato 48V DC DALI.

ACCESSORIO OBBLIGATORIO

Repeater device for opto-isolating the data bus, for 48V DC DALI electrified track.

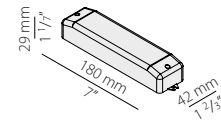
MANDATORY ACCESSORY**YDV.048.075.A01**

Alimentatore LED, 75W 48V DC, on/off.

LED driver, 75W 48V DC, on/off.

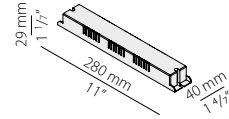

0,23

YDV.048.150.A01

Alimentatore LED, 150W 48V DC, on/off.

LED driver, 150W 48V DC, on/off.

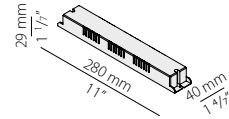

0,25

XM9500-CUT

Taglio lineare per binario Astoria.

Linear cut for Astoria track.



QUEENS 45



Queens 45 è un proiettore dalle dimensioni compatte per binari elettrificati trifase, progettato per LED COB di ultima generazione. La disponibilità di differenti fasci luminosi e l'orientamento del corpo fino a 355° consentono molteplici soluzioni e regie luminose nel retail, spazi commerciali, musei ed aree espositive. Viene fornito completo di riflettore termoplastico metallizzato a specchio con ottica standard a fascio medio. Ottiche per fascio stretto o largo ordinabili su richiesta. Disponibile nella versione 3000K e nei colori bianco e nero.

Queens 45 is a compact projector for tri-phase electrified tracks, engineered with COB LEDs of latest generation. The availability of different light beams and the 355° adjustment of the light direction allows multiple solutions and scenarios in retail stores, commercial spaces, museums, exhibition halls. Supplied with metallized mirrored thermoplastic reflector with standard lens with medium beam. Reflectors for narrow or wide beam available upon request. Available in 3000K and in white or black finish.

	CODICE CODE	FONTI LUMINOSE LIGHT SOURCES	kg
	B77001.037.4001	Potenza assorbita apparecchio / Luminaire power consumption 37W	0,90
	B77002.037.4001	Flusso luminoso apparecchio / Luminaire luminous flux 4450lm 3000K Ra>85 30° 220-240V AC ON-OFF IP20 850°	

	STANDARD	Ottica per fascio medio. Flood optic.
	XMR1	Ottica per fascio stretto. Spot optic.
	XMR3	Ottica per fascio largo. Wide flood optic.

Fotometrie disponibili www.panzeri.it / Photometric data available at www.panzeri.it

CODICI COLORI DISPONIBILI / COLOUR CODES AVAILABLE

01 bianco
white **02** nero
black



QUEENS 25



Proiettore in pressofusione di alluminio a dissipazione termica passiva per binario elettrificato trifase, con LED ad alta efficienza e adattatore integrato. Può essere ruotato rispetto all'asse verticale fino a 355° e di 90° verso l'alto. Riflettore termoplastico metallizzato a specchio con ottica standard a fascio medio e ottiche per fascio stretto, largo o molto largo disponibili su richiesta. Disponibile nelle versioni 3000K e 4000K e nei colori bianco e nero.

Die-cast aluminium spotlight with passive thermal dissipation for three-phase electrified track, equipped with high efficiency LED and integrated adapter. It can rotate up to 355° with respect to the vertical axis and pivot up to 90° upwards. Mirror-metallized thermoplastic reflector with flood standard light beam and spot, wide flood or extra wide flood optics available on request. Available in 3000K and 4000K versions, in white and black colours.

	CODICE CODE	FONTI LUMINOSE LIGHT SOURCES	kg
	XM751-30-01-3K XM751-30-02-3K	Potenza assorbita apparecchio / Luminaire power consumption 30W Flusso luminoso apparecchio / Luminaire luminous flux 2552lm 3000K Ra>85 29° 220-240V AC ON-OFF IP20 850°	1,04
	XM751-30-01-4K XM751-30-02-4K	Potenza assorbita apparecchio / Luminaire power consumption 30W Flusso luminoso apparecchio / Luminaire luminous flux 2617lm 4000K Ra>85 29° 220-240V AC ON-OFF IP20 850°	1,04
	STANDARD	Ottica per fascio medio. Flood optic.	
	XMR5	Ottica per fascio stretto Spot optic	0,01
	XMR7	Ottica per fascio largo Wide flood optic	0,01
	XMR8	Ottica per fascio largo Wide flood optic	0,01

Fotometrie disponibili www.panzeri.it / Photometric data available at www.panzeri.it UGR < 16 in funzione delle condizioni di installazione / UGR < 16 depending on installation conditions

CODICI COLORI DISPONIBILI / COLOUR CODES AVAILABLE

- 01** bianco / white
- 02** nero / black



QUEENS 20



Queens 20 è un proiettore dalle dimensioni compatte per binari elettrificati trifase, progettato per LED COB di ultima generazione. La disponibilità di differenti fasci luminosi consente molteplici soluzioni e regie luminose nel retail, spazi commerciali, musei ed aree espositive. Viene fornito completo di riflettore termoplastico metallizzato a specchio con ottica standard a fascio medio. Ottiche per fascio stretto o largo ordinabili su richiesta. Disponibile nella versione 3000K e nei colori bianco e nero.

Queens 20 is a compact projector for tri-phase electrified tracks, engineered with COB LEDs of latest generation. The availability of different light beams allows multiple solutions and scenarios in retail stores, commercial spaces, museums, exhibition halls. Supplied with metallized mirrored thermoplastic reflector with standard lens with a medium beam. Reflectors for narrow or wide beam available upon request. Available in 3000K and in white or black finish.

	CODICE CODE	FONTE LUMINOSA LIGHT SOURCES	kg
	B76001.026.2501	Potenza assorbita apparecchio / Luminaire power consumption 26W	0,40
	B76002.026.2501	Flusso luminoso apparecchio / Luminaire luminous flux 1890lm 3000K Ra>90 30° 220-240V AC ON-OFF	
		IP20 850°	

	STANDARD	Ottica per fascio medio. Flood optic.	
	XMR5	Ottica per fascio stretto Spot optic	0,01
	XMR7	Ottica per fascio largo Wide flood optic	0,01

Fotometrie disponibili www.panzeri.it / Photometric data available at www.panzeri.it

CODICI COLORI DISPONIBILI / COLOUR CODES AVAILABLE

01 bianco
white **02** nero
black





QUEENS 10



Proiettore in pressofusione di alluminio a dissipazione termica passiva con adattatore per binario elettrificato trifase, equipaggiato con LED ad alta efficienza. Può essere ruotato rispetto all'asse verticale di 355° e di 90° verso l'alto. Cilindro antiabbagliamento di serie. Riflettore termoplastico metallizzato a specchio con ottica standard a fascio medio e ottiche per fascio stretto o largo disponibili su richiesta. Disponibile nella versione 3000K e nei colori bianco e nero.

Die-cast aluminium spotlight with passive thermal dissipation with adapter for threephase electrified track, equipped with high efficiency LED. It can rotate up to 355° with respect to the vertical axis and pivot up to 90° upwards. Standard anti-glare snoot. Mirror-metallized thermoplastic reflector with flood standard light beam and spot or wide flood optics available on request. Available in 3000K version, in white and black colours.

CODICE CODE	FONTI LUMINOSE LIGHT SOURCES	kg
 XM748-12-01-3K XM748-12-02-3K	Potenza assorbita apparecchio / Luminaire power consumption 12W Flusso luminoso apparecchio / Luminaire luminous flux 1221lm 3000K Ra>90 30° 220-240V AC ON-OFF  IP20 850°	0,50

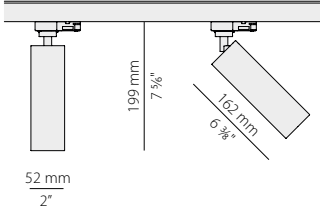

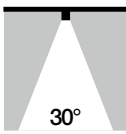
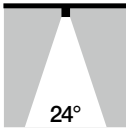
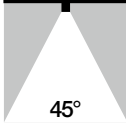
	STANDARD	Ottica per fascio medio. Flood optic.	
	XMR5	Ottica per fascio stretto Spot optic	0,01
	XMR7	Ottica per fascio largo Wide flood optic	0,01

Fotometrie disponibili www.panzeri.it / Photometric data available at www.panzeri.it UGR < 11 in funzione delle condizioni di installazione / UGR < 11 depending on installation conditions

CODICI COLORI DISPONIBILI / COLOUR CODES AVAILABLE

- 01** bianco / white
- 02** nero / black

QUEENS



Sistema di binari trifase a tre accensioni (tensione di rete 230/250V, tensione di rete industriale 380/440V, carico complessivo 16A) disponibile in tre differenti lunghezze per applicazioni a plafone e a sospensione. Il sistema è costruito in lega di alluminio estruso con cavi conduttori in rame alloggiati all'interno di profilati estrusi in PVC ad alta resistenza di isolamento. Il sistema è a sezione quadra in colore bianco o nero e comprende un'ampia varietà di accessori e giunti di collegamento che lo rendono ideale nella progettazione illuminotecnica per flessibilità e versatilità.

System of three-phase tracks with three circuits (power supply 230/250V, industrial power supply 380/440V, total load 16A) available in three different lengths for installation at the ceiling or suspended. The system is made of extruded aluminium alloy with copper wires located inside the extruded PVC profiles with high insulating properties. The system is square-shaped in colour white or black and includes a wide range of accessories and joints that makes it extremely flexible and versatile in lighting design.

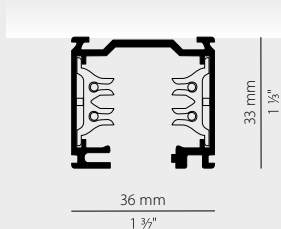

THREE-PHASE ELECTRIFIED TRACK

IP20 850°

CODICE / CODE	L MM	L INCHES	kg
XM7501-100	1000	39 2/5"	0,80
XM7502-100	1000	39 2/5"	0,80
XM7501-200	2000	78 4/5"	1,60
XM7502-200	2000	78 4/5"	1,60
XM7501-300	3000	118 1/2"	2,40
XM7502-300	3000	118 1/2"	2,40

CODICI COLORI DISPONIBILI / COLOUR CODES AVAILABLE

01 bianco
white

02 nero
black

ACCESSORI / ACCESSORIES

XM7501
XM7502
Adattatore elettromeccanico 6A, portata 5kg, per binario elettrificato trifase.
Electro/mechanical adapter 6A, mechanical load 5kg, for three-phase electrified track.

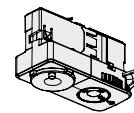

kg

0,05

XM76ADX01
XM76ADX02
Alimentazione destra per binario elettrificato trifase.
Right live-end for three-phase electrified track.

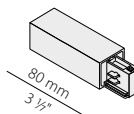

0,09

XM76ASX01
XM76ASX02
Alimentazione sinistra per binario elettrificato trifase.
Left live-end for three-phase electrified track.

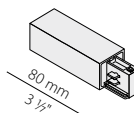



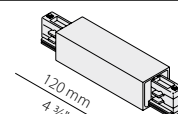

0,09

XM76A01
XM76A02
Alimentazione centrale e giunzione lineare per binario elettrificato trifase.
Central connector and straight joint for three-phase electrified track.

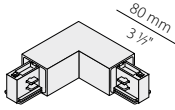
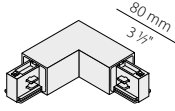
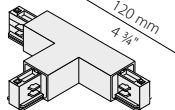
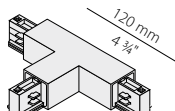
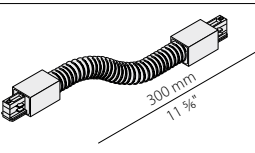

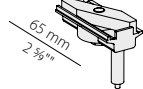
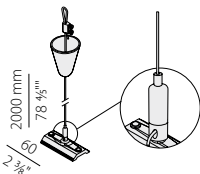
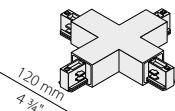
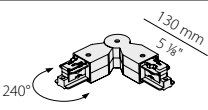
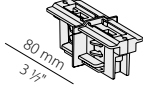
0,17

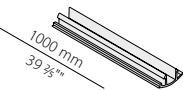
	kg
XM76LI01 XM76LI02 Giunzione a "L" interna per binario elettrificato trifase. Internal "L" joint for three-phase electrified track.	 0,17
XM76LE01 XM76LE02 Giunzione a "L" esterna per binario elettrificato trifase. External "L" joint for three-phase electrified track.	 0,17
XM76TDX01 XM76TDX02 Giunzione a "T" destra per binario elettrificato trifase. Right "T" joint for three-phase electrified track.	 0,20
XM76TSX01 XM76TSX02 Giunzione a "T" sinistra per binario elettrificato trifase. Left "T" joint for three-phase electrified track.	 0,20
XM76F01 XM76F02 Giunzione flessibile per binario elettrificato trifase. Flexible joint for three-phase electrified track.	 0,25
XM76U01 XM76U02 Giunzione lineare senza contatti per binario elettrificato trifase. Mechanical straight joint for three-phase electrified track.	 0,04
XM76B01 XM76B02 Adattatore meccanico con bloccacavo automatico per binario elettrificato trifase. Mechanical adapter with automatic locking for three-phase electrified track.	 0,10
XM76S01 XM76S02 Kit di sospensione con fune in acciaio di lunghezza 2m (78,7") e piattina per binario elettrificato trifase. Suspension kit with 2m (78,7") long steel wire and plate for three-phase electrified track.	 0,05
XM76X01 XM76X02 Giunzione a "X" per binario elettrificato trifase. "X" joint for three-phase electrified track.	 0,30
XM76M01 XM76M02 Giunzione mobile per binario elettrificato trifase. Mobile joint for three-phase electrified track.	 0,17
XM76Q01 XM76Q02 Giunzione lineare con contatti e con blocco per binario elettrificato trifase. Electrical straight joint with stop for three-phase electrified track.	 0,05
XM76K Kit per attacco a soffitto per binario elettrificato trifase. Ceiling kit for three-phase electrified track.	 0,02
XM76E01 XM76E02 Testata di chiusura per binario elettrificato trifase. End cap for three-phase electrified track.	 0,01
XM76C01 XM76C02 Copertura di lunghezza 1000mm (39,4") per binario elettrificato trifase. Cover 1000mm (39,4") long for three-phase electrified track.	 0,06



SOHO 20





355°

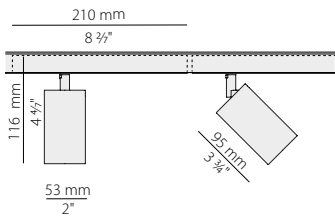

Proiettore in pressofusione di alluminio con LED ad alta efficienza e adattatore integrato per binario elettrificato a bassa tensione 48V. Cilindro antiabbagliamento e vetro zigrinato di serie. Riflettore termoplastico metallizzato a specchio con ottica standard a fascio medio e ottiche per fascio stretto o largo disponibili su richiesta. Disponibile nella versione 3000K e nei colori bianco e nero.

Die-cast aluminium spotlight with high efficiency LED and integrated adapter for 48V low voltage electrified track. Standard anti-glare snoot and prismatic spread lens. Mirror-metallized thermoplastic reflector with flood standard light beam and spot or wide flood optics available on request. Available in 3000K version, in white and black colours.



CODICE CODE	FONTI LUMINOSE LIGHT SOURCES	kg
-------------	------------------------------	----



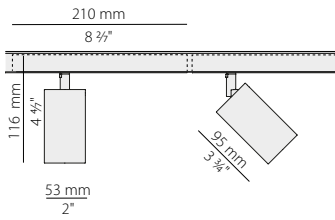

  **B75401.026.2516**
B75402.026.2516

Potenza assorbita apparecchio / Luminaire power consumption 26W 0,40
 Flusso luminoso apparecchio / Luminaire luminous flux 1890lm
 3000K Ra>90 30° 48V DC ON-OFF
 IP20 850° 



  **B75401.026.2519**
B75402.026.2519

Potenza assorbita apparecchio / Luminaire power consumption 26W 0,40
 Flusso luminoso apparecchio / Luminaire luminous flux 1890lm
 3000K Ra>90 30° 48V DC dimmable (DALI)
 IP20 850° 

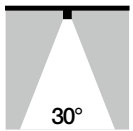

STANDARD Ottica per fascio medio.
Flood optic.

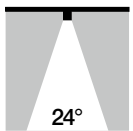

XMR5 Ottica per fascio stretto
Spot optic 0,01

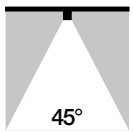

XMR7 Ottica per fascio largo
Wide flood optic 0,01



XMR12 Cilindro interno colore oro satinato
Internal satin gold cylinder 0,02

Fotometrie disponibili www.panzeri.it / Photometric data available at www.panzeri.it

UGR < 16 in funzione delle condizioni di installazione / UGR < 16 depending on installation conditions

CODICI COLORI DISPONIBILI / COLOUR CODES AVAILABLE

01 bianco
white **02** nero
black



SOHO 10



Proiettore in pressofusione di alluminio con LED ad alta efficienza e adattatore integrato per binario elettrificato a bassa tensione 48V. Cilindro antiabbagliamento e vetro zigrinato di serie. Riflettore termoplastico metallizzato a specchio con ottica standard a fascio medio e ottiche per fascio stretto o largo disponibili su richiesta. Disponibile nella versione 3000K e nei colori bianco e nero.

Die-cast aluminium spotlight with high efficiency LED and integrated adapter for 48V low voltage electrified track. Standard anti-glare snoot and prismatic spread lens. Mirror-metallized thermoplastic reflector with flood standard light beam and spot or wide flood optics available on request. Available in 3000K version, in white and black colours.

	CODICE CODE	FONTI LUMINOSE LIGHT SOURCES	kg
	B75301.018.2516	Potenza assorbita apparecchio / Luminaire power consumption 18W	0,40
	B75302.018.2516	Flusso luminoso apparecchio / Luminaire luminous flux 1436lm 3000K Ra>90 30° 48V DC ON-OFF IP20 850°	
	B75301.018.2519	Potenza assorbita apparecchio / Luminaire power consumption 18W	0,40
	B75302.018.2519	Flusso luminoso apparecchio / Luminaire luminous flux 1436lm 3000K Ra>90 30° 48V DC dimmable (DALI) IP20 850°	
	STANDARD	Ottica per fascio medio. Flood optic.	
	XMR10	Ottica per fascio stretto Spot optic	0,04
	XMR11	Ottica per fascio largo Wide flood optic	0,04
	XMR12	Cilindro interno colore oro satinato Internal satin gold cylinder	0,02

Fotometrie disponibili www.panzeri.it / Photometric data available at www.panzeri.it

UGR < 16 in funzione delle condizioni di installazione / UGR < 16 depending on installation conditions

CODICI COLORI DISPONIBILI / COLOUR CODES AVAILABLE

01 bianco
white

02 nero
black



SOHO 5



Proiettore in pressofusione di alluminio con LED ad alta efficienza e adattatore integrato per binario elettrificato a bassa tensione 48V. Completo di cilindro antiabbagliamento e lente per fascio stretto in materiale termoplastico.
Disponibile nella versione 3000K e nei colori bianco e nero.

Die-cast aluminium spotlight with high efficiency LED and integrated adapter for 48V low voltage electrified track. Complete with standard anti-glare snoot and thermoplastic lens for narrow beam. Available in 3000K version, in white and black colours.

	CODICE CODE	FONTI LUMINOSE LIGHT SOURCES	kg
	B75201.008.2416	Potenza assorbita apparecchio / Luminaire power consumption 7,3W	0,30
	B75202.008.2416	Flusso luminoso apparecchio / Luminaire luminous flux 613lm 3000K Ra>90 14° 48V DC ON-OFF IP20 850°	
	B75201.008.2419	Potenza assorbita apparecchio / Luminaire power consumption 7,3W	0,30
	B75202.008.2419	Flusso luminoso apparecchio / Luminaire luminous flux 613lm 3000K Ra>90 14° 48V DC dimmable (DALI) IP20 850°	

Fotometrie disponibili www.panzeri.it / Photometric data available at www.panzeri.it

CODICI COLORI DISPONIBILI / COLOUR CODES AVAILABLE

- 01** bianco / white
- 02** nero / black



SOHO LINE



Modulo lineare a luce diffusa per binari elettrificati a bassa tensione 48V per applicazioni soffitto/parete, sospensione e incasso, con schermo in policarbonato opale. Trasformatore elettronico remoto per binario 48V da ordinare separatamente. Disponibile in colore bianco o nero.

Linear diffused LED module with opal polycarbonate screen for 48V low voltage electrified tracks for ceiling/wall, suspension and recessed applications. Electronic transformer for remote use for 48V track to order separately. White and black finishes are available.

	CODICE CODE	FONTI LUMINOSE LIGHT SOURCES	kg
	B47001.060.0416 B47002.060.0416	Potenza assorbita apparecchio / Luminaire power consumption 12W Flusso luminoso apparecchio / Luminaire luminous flux 740lm 3000K Ra>90 48V DC ON-OFF IP20	0,30
	B47001.060.0419 B47002.060.0419	Potenza assorbita apparecchio / Luminaire power consumption 7,5W Flusso luminoso apparecchio / Luminaire luminous flux 470lm 3000K Ra>90 48V DC dimmable (DALI) IP20	0,30
	B47001.090.0416 B47002.090.0416	Potenza assorbita apparecchio / Luminaire power consumption 19W Flusso luminoso apparecchio / Luminaire luminous flux 1244lm 3000K Ra>90 48V DC ON-OFF IP20	0,30
	B47001.090.0419 B47002.090.0419	Potenza assorbita apparecchio / Luminaire power consumption 15W Flusso luminoso apparecchio / Luminaire luminous flux 940lm 3000K Ra>90 48V DC dimmable (DALI) IP20	0,30

Fotometrie disponibili www.panzeri.it / Photometric data available at www.panzeri.it

CODICI COLORI DISPONIBILI / COLOUR CODES AVAILABLE

01 bianco
white

02 nero
black

SOHO IN



Sistema di binari a bassa tensione 48V, disponibile in tre differenti lunghezze per applicazioni ad incasso. Il sistema è costruito in lega di alluminio estruso verniciato poliester, predisposto per alloggiare i proiettori provvisti di adattatore 48V. Possibilità di regolazione DALI. Il sistema è a sezione quadra, in colore nero. Disponibile un'ampia varietà di accessori e giunti di collegamento.

System of 48V electrified tracks, available in three different lengths for recessed use. The system is made of extruded aluminium alloy with polyester coating, suitable to host spotlights equipped with 48V adapter. Possibility of DALI dimming. The system is square-shaped, in black colour. Wide range of available accessories and joints.

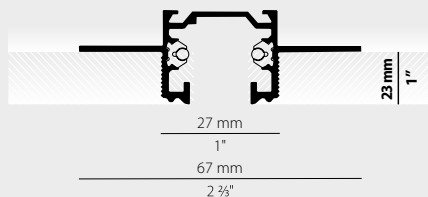

TRIMLESS RECESSED ELECTRIFIED TRACK 48V DC

IP20 850°

CODICE / CODE	L MM	L INCHES	kg
XM44602-100	1000	39 3/8"	0,73
XM44602-200	2000	78 7/8"	1,45
XM44602-300	3000	118 1/2"	2,18

CODICI COLORI DISPONIBILI / COLOUR CODES AVAILABLE

02 nero
black

ACCESSORI / ACCESSORIES

XM44501-C
XM44502-C

Copertura di lunghezza 1000mm (39,4") per binario elettrificato 48V DC.
Cover 1000mm (39,4") long for 48V DC electrified track.

kg

0,10

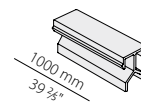

XM44602-ADX

Alimentazione destra per binario elettrificato 48V DC da incasso.
Right live-end for 48V DC recessed electrified track.

0,04

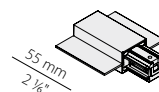

XM44602-ASX

Alimentazione sinistra per binario elettrificato 48V DC da incasso.
Left live-end for 48V DC recessed electrified track.

0,04

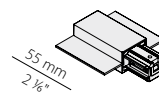

XM44602-A

Alimentazione centrale per binario elettrificato 48V DC da incasso.
Central connector for 48V DC recessed electrified track.

0,07

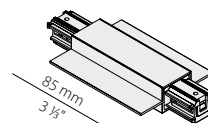

XM44502-UE

Giunto lineare per binario elettrificato 48V DC.
Straight joint for 48V DC electrified track.

0,02

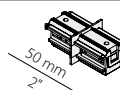

XM44502-UM

Giunto lineare senza contatti per binario elettrificato 48V DC.
Mechanical straight joint for 48V DC electrified track.

0,01

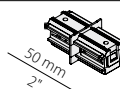

ACCESSORI / ACCESSORIES

		kg
XM44602-LI Giunzione a "L" interna per binario elettrificato 48V DC a incasso. Internal "L" joint for 48V DC recessed electrified track.		0,06
XM44602-LE Giunzione a "L" esterna per binario elettrificato 48V DC a incasso. External "L" joint for 48V DC recessed electrified track.		0,06
YDV.048.150.A02 Trasformatore elettronico DALI, 150W 48V DC, per binario elettrificato 48V DC. DALI electronic transformer, 150W 48V DC, for 48V DC electrified track.		0,40
YDV.048.075.A01 Trasformatore elettronico, 75W 48V DC, per binario elettrificato 48V DC. Electronic transformer, 75W 48V DC, for 48V DC electrified track.		0,38
YDV.048.150.A01 Trasformatore elettronico, 150W 48V DC, per binario elettrificato 48V DC. Electronic transformer, 150W 48V DC, for 48V DC electrified track.		0,38
XM44602-E Testata di chiusura per binario elettrificato 48V DC da incasso. End cap for 48V DC recessed electrified track.		0,07
XM446-P Piastrina per fissaggio a plafone binario elettrificato 48V DC da incasso. ACCESSORIO OBBLIGATORIO DA POSIZIONARE OGNI METRO CIRCA. Plate for fixing ceiling pendants for 48V DC recessed electrified track. MANDATORY ACCESSORY TO BE POSITIONED EVERY METER APPROX.		0,05

SOHO OUT

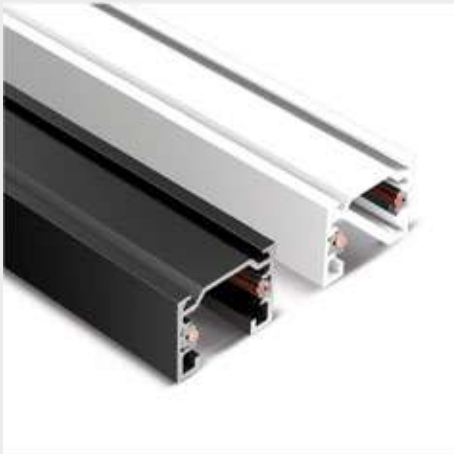

Sistema di binari a bassa tensione 48V, disponibile in tre differenti lunghezze per applicazioni a soffitto/parete e a sospensione. Il sistema è costruito in lega di alluminio estruso verniciato poliestere, predisposto per alloggiare i proiettori provvisti di adattatore 48V. Possibilità di regolazione DALI. Il sistema è a sezione quadra, in colore bianco e nero. Disponibile un'ampia varietà di accessori e giunti di collegamento.

System of 48V electrified tracks, available in three different lengths for ceiling/wall or suspended use. The system is made of extruded aluminium alloy with polyester coating, suitable to host spotlights equipped with 48V adapter. Possibility of DALI dimming. The system is square-shaped, in white or black colour. Wide range of available accessories and joints.

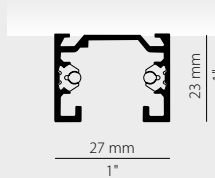

ELECTRIFIED TRACK 48V DC

IP20 850°

CODICE / CODE	L MM	L INCHES	kg
XM44501-100	1000	39 2/5"	0,50
XM44502-100	1000	39 2/5"	0,50
XM44501-200	2000	78 4/5"	1,00
XM44502-200	2000	78 4/5"	1,00
XM44501-300	3000	118 1/5"	1,70
XM44502-300	3000	118 1/5"	1,70

CODICI COLORI DISPONIBILI / COLOUR CODES AVAILABLE

01 bianco
white

02 nero
black

ACCESSORI / ACCESSORIES

XM44501-C

XM44502-C

Copertura di lunghezza 1000mm (39,4") per binario elettrificato 48V DC.
Cover 1000mm (39,4") long for 48V DC electrified track.

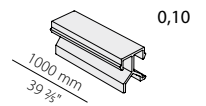

kg

0,10

XM44501-ADX

XM44502-ADX

Alimentazione destra per binario elettrificato 48V DC a sospensione o a soffitto.
Right live-end for 48V DC suspended or ceiling electrified track.

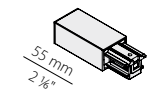

0,04

XM44501-ASX

XM44502-ASX

Alimentazione sinistra per binario elettrificato 48V DC a sospensione o a soffitto.
Left live-end for 48V DC suspended or ceiling electrified track.

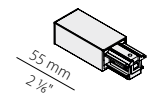

0,04

XM44501-A

XM44502-A

Alimentazione centrale per binario elettrificato 48V DC a sospensione o a soffitto.
Central connector for 48V DC suspended or ceiling electrified track.

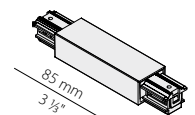

0,06



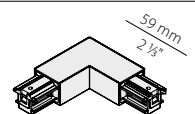

XM44501-LI

XM44502-LI

Giunzione a "L" interna per binario elettrificato 48V DC a sospensione o a soffitto.
Internal "L" joint for 48V DC suspended or ceiling electrified track.

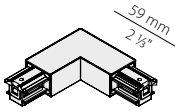
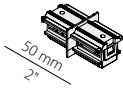
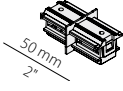
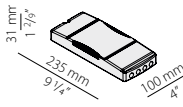
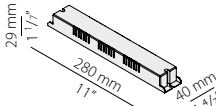
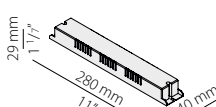

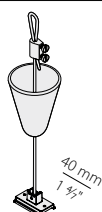
0,06

	kg
XM44501-LE XM44502-LE Giunzione a "L" esterna per binario elettrificato 48V DC a sospensione o a soffitto. External "L" joint for 48V DC suspended or ceiling electrified track.	 0,06
XM44501-UE XM44502-UE Giunto lineare per binario elettrificato 48V DC. Straight joint for 48V DC electrified track.	 0,02
XM44501-UM XM44502-UM Giunto lineare senza contatti per binario elettrificato 48V DC. Mechanical straight joint for 48V DC electrified track.	 0,01
YDV.048.150.A02 Trasformatore elettronico DALI, 150W 48V DC, per binario elettrificato 48V DC. DALI electronic transformer, 150W 48V DC, for 48V DC electrified track.	 0,40
YDV.048.075.A01 Trasformatore elettronico, 75W 48V DC, per binario elettrificato 48V DC. Electronic transformer, 75W 48V DC, for 48V DC electrified track.	 0,38
YDV.048.150.A01 Trasformatore elettronico, 150W 48V DC, per binario elettrificato 48V DC. DC. Electronic transformer, 150W 48V DC, for 48V DC electrified track.	 0,38
XM44501-E XM44502-E Testata di chiusura per binario elettrificato 48V DC a sospensione o a soffitto. End cap for 48V DC suspended or ceiling electrified track.	 0,10
XM44501-S XM44502-S Kit di sospensione con fune in acciaio di lunghezza 2m (78,7") e piattina per binario elettrificato 48V DC. Suspension kit with 2m (78,7") long steel wire and plate for 48V DC electrified track.	 0,03
XM44501-K XM44502-K Kit per attacco a soffitto per binario elettrificato 48V DC. Ceiling kit for 48V DC electrified track.	 0,03



432 WAYS

Officina Panzeri 2025



Apparecchio di illuminazione ad emissione diretta, con supporto lente con ottica arretrata e lente emisferica anti-abbagliamento. Disponibili le finiture bianco, nero, champagne, bronzo, ottone satinato, verde oliva materico e terracotta naturale materico, che rendono questo spotlight uno strumento di personalizzazione degli spazi in cui è inserito.

Direct-emission fixture, with lens holder with recessed optics and anti-glare hemispherical lens. White, black, champagne, bronze, matte brass, textured olive green and natural textured terracotta finishes are available, making this spotlight a customisation tool for the spaces in which it is placed.

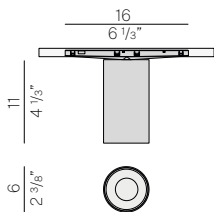

Compatibile con binario Street
Compatible with Street track

CODICE CODE	FONTI LUMINOSE LIGHT SOURCES	kg
-------------	------------------------------	----

BP12701.006.0519	Potenza assorbita apparecchio / Luminaire power consumption 6,7W	
BP12702.006.0519	Flusso luminoso apparecchio / Luminaire luminous flux 773lm	
BP12705.006.0519	2700K Ra>90 29° 48V DC dimmable (DALI)	
BP12717.006.0519	IP20	
BP12719.006.0519	Necessario acquistare separatamente il supporto lente YSL127__006.FL	
BP12727.006.0519	The YSL127__006.FL lens holder must be purchased separately	
BP12729.006.0519		

BP12701.006.0419	Potenza assorbita apparecchio / Luminaire power consumption 6,7W	
BP12702.006.0419	Flusso luminoso apparecchio / Luminaire luminous flux 773lm	
BP12705.006.0419	3000K Ra>90 29° 48V DC dimmable (DALI)	
BP12717.006.0419	IP20	
BP12719.006.0419	Necessario acquistare separatamente il supporto lente YSL127__006.FL	
BP12727.006.0419	The YSL127__006.FL lens holder must be purchased separately	
BP12729.006.0419		

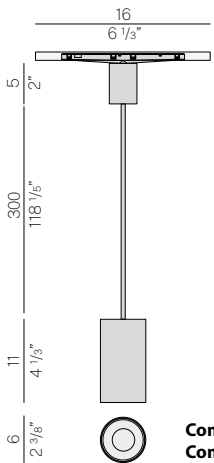

Compatibile con binario Street
Compatible with Street track

BL12701.006.0519	Potenza assorbita apparecchio / Luminaire power consumption 6,7W	
BL12702.006.0519	Flusso luminoso apparecchio / Luminaire luminous flux 773lm	
BL12705.006.0519	2700K Ra>90 29° 48V DC dimmable (DALI)	
BL12717.006.0519	IP20	
BL12719.006.0519	Necessario acquistare separatamente il supporto lente YSL127__006.FL	
BL12727.006.0519	The YSL127__006.FL lens holder must be purchased separately	
BL12729.006.0519		

BL12701.006.0419	Potenza assorbita apparecchio / Luminaire power consumption 6,7W	
BL12702.006.0419	Flusso luminoso apparecchio / Luminaire luminous flux 773lm	
BL12705.006.0419	3000K Ra>90 29° 48V DC dimmable (DALI)	
BL12717.006.0419	IP20	
BL12719.006.0419	Necessario acquistare separatamente il supporto lente YSL127__006.FL	
BL12727.006.0419	The YSL127__006.FL lens holder must be purchased separately	
BL12729.006.0419		



Supporto lente obbligatorio non incluso, da acquistare separatamente.
Mandatory lens holder not included, to be purchased separately.

YSL12701.006.FL	Supporto lente per 432 Ways, in alluminio, con verniciatura poliaccrilica in colore bianco, nero, bronzo, ottone satinato, verde oliva materico o terracotta naturale materico.	0,07
YSL12702.006.FL		
YSL12705.006.FL		
YSL12717.006.FL		
YSL12719.006.FL		
YSL12727.006.FL		
YSL12729.006.FL		

Fotometrie disponibili www.panzeri.it / Photometric data available at www.panzeri.it

CODICI COLORI DISPONIBILI / COLOUR CODES AVAILABLE

01 bianco white	02 nero black	05 champagne champagne	17 bronzo bronze	19 ottone satinato matte brass	27 verde oliva materico textured olive green	29 terracotta naturale materico textured natural terracotta
------------------------	----------------------	-------------------------------	-------------------------	---------------------------------------	---	--





Lampada da sospensione con testa in pressofusione di alluminio, disponibile in versione a emissione diretta e indiretta. Diffusore in materiale acrilico con perimetro luminoso. Disponibile paralume in tessuto color avorio "Bella vestita" disegnato da Matteo Thun, da ordinare separatamente. Bianco, nero, champagne, titanio, bronzo e ottone satinato le finiture disponibili.

Suspension lamp with die-cast aluminium head, available in direct and indirect light versions. Diffuser in acrylic material with luminous perimeter. Ivory fabric lampshade "Bella vestita" designed by mateo Thun is available, to order separately. White, black, champagne, titanium, bronze and matte brass finishes are available.

CODICE CODE	FONTI LUMINOSE LIGHT SOURCES	kg
-------------	------------------------------	----

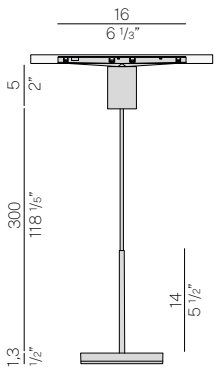

	BL05201.011.0519 Potenza assorbita apparecchio / Luminaire power consumption 6,5W
	BL05202.011.0519 Flusso luminoso apparecchio / Luminaire luminous flux 388lm
	BL05205.011.0519 2700K Ra>90 48V DC dimmable (DALI)
	BL05217.011.0519 IP20
	BL05219.011.0519

	BL05201.011.0419 Potenza assorbita apparecchio / Luminaire power consumption 6,5W
	BL05202.011.0419 Flusso luminoso apparecchio / Luminaire luminous flux 388lm
	BL05205.011.0419 3000K Ra>90 48V DC dimmable (DALI)
	BL05217.011.0419 IP20
	BL05219.011.0419

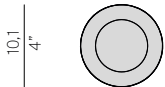

Compatibile con binario Street
Compatible with Street track

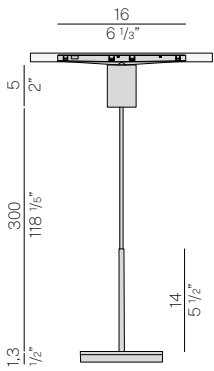

	BL05301.011.0519 Potenza assorbita apparecchio / Luminaire power consumption 6,5W
	BL05302.011.0519 Flusso luminoso apparecchio / Luminaire luminous flux 388lm
	BL05305.011.0519 2700K Ra>90 48V DC dimmable (DALI)
	BL05317.011.0519 IP20
	BL05319.011.0519

	BL05301.011.0419 Potenza assorbita apparecchio / Luminaire power consumption 6,5W
	BL05302.011.0419 Flusso luminoso apparecchio / Luminaire luminous flux 388lm
	BL05305.011.0419 3000K Ra>90 48V DC dimmable (DALI)
	BL05317.011.0419 IP20
	BL05319.011.0419

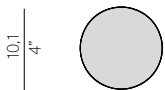

Compatibile con binario Street
Compatible with Street track

Fotometrie disponibili www.panzeri.it / Photometric data available at www.panzeri.it

CODICI COLORI DISPONIBILI / COLOUR CODES AVAILABLE

01 bianco white	02 nero black	05 champagne champagne	17 bronzo bronze	19 ottone satinato matte brass
---------------------------	-------------------------	----------------------------------	----------------------------	--





La tradizione nella lavorazione a mano del vetro soffiato dà vita alla famiglia Murané, una serie di corpi illuminanti a sospensione, soffitto e parete. L'adattatore per binario, provvisto per la versione a sospensione di un piccolo rosone per il collegamento elettrico, è fornito in finitura nera. Il diffusore sferico in vetro in diverse finiture è lavorato internamente, con un effetto ondulato di grande impatto decorativo. La sorgente LED di piccole dimensioni è mascherata da un'apposita copertura in policarbonato, che contribuisce a una diffusione ottimale del fascio luminoso.

The tradition in the hand-made craftsmanship of blown glass gives birth to Murané, a series of suspensions, surface or ceiling mount fittings. The track adaptor, equipped for the suspension version with a small canopy for electrical connection, is supplied in black finish. The spherical diffuser transparent in glass, in different colours, is hand-crafted with a wavy effect of great decorative effect. The LED source is minimal and hidden in a polycarbonate cover, that ensures an optimal light diffusion.

CODICE CODE	FONTI LUMINOSE LIGHT SOURCES	kg
-------------	------------------------------	----

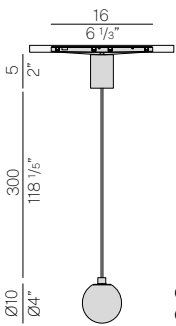

Compatibile con binario Street
Compatible with Street track



- BL11305.010.0519** vetro caramello / caramel glass
- BL11405.010.0519** vetro rosa / pink glass
- BL11505.010.0519** vetro bronzo / bronze glass
- BL11705.010.0519** vetro trasparente / transparent glass
- BL11805.010.0519** vetro fumè / smoke grey glass
- BL11905.010.0519** vetro verde foresta / forest green glass

Potenza assorbita apparecchio / Luminaire power consumption 4W
Flusso luminoso apparecchio / Luminaire luminous flux 167lm
2700K Ra>90 48V DC dimmable (DALI)

IP20

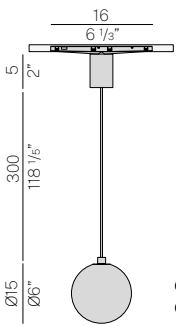

Compatibile con binario Street
Compatible with Street track



- BL11305.015.0519** vetro caramello / caramel glass
- BL11405.015.0519** vetro rosa / pink glass
- BL11505.015.0519** vetro bronzo / bronze glass
- BL11705.015.0519** vetro trasparente / transparent glass
- BL11805.015.0519** vetro fumè / smoke grey glass
- BL11905.015.0519** vetro verde foresta / forest green glass

Potenza assorbita apparecchio / Luminaire power consumption 4W
Flusso luminoso apparecchio / Luminaire luminous flux 167lm
2700K Ra>90 48V DC dimmable (DALI)

IP20

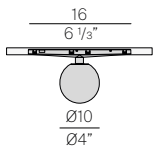

Compatibile con binario Street
Compatible with Street track



- BP11305.010.0519** vetro caramello / caramel glass
- BP11405.010.0519** vetro rosa / pink glass
- BP11505.010.0519** vetro bronzo / bronze glass
- BP11705.010.0519** vetro trasparente / transparent glass
- BP11805.010.0519** vetro fumè / smoke grey glass
- BP11905.010.0519** vetro verde foresta / forest green glass

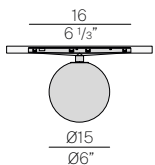

Compatibile con binario Street
Compatible with Street track



- BP11305.015.0519** vetro caramello / caramel glass
- BP11405.015.0519** vetro rosa / pink glass
- BP11505.015.0519** vetro bronzo / bronze glass
- BP11705.015.0519** vetro trasparente / transparent glass
- BP11805.015.0519** vetro fumè / smoke grey glass
- BP11905.015.0519** vetro verde foresta / forest green glass

Potenza assorbita apparecchio / Luminaire power consumption 4W
Flusso luminoso apparecchio / Luminaire luminous flux 167lm
2700K Ra>90 48V DC dimmable (DALI)

IP20

Fotometrie disponibili www.panzeri.it / Photometric data available at www.panzeri.it

CODICI COLORI DISPONIBILI / COLOUR CODES AVAILABLE

COLORE VETRI / GLASSES COLOUR

05 champagne
champagne

113 caramello
caramel

114 rosa
pink

115 bronzo
bronze

117 trasparente
transparent

118 fumè
smoke grey

119 verde foresta
forest green





RENDEZ-VOUS

Philip Platino 2025



Rendez-vous è un apparecchio di illuminazione dalle dimensioni minime realizzato rispettando le proporzioni auree. Prendendo spunto dal concetto di incontro, può essere utilizzato singolarmente o in composizione multiple scenografiche, in cluster o lineari, realizzabili attraverso l'utilizzo di rosoni e accessori appositamente progettati. La piccola testa conica in pressofusione di alluminio è disponibile in finitura nero satinato e bronzo; nasconde al suo interno una sorgente LED e una lente per dirigere il fascio.

Rendez-vous is a luminaire with minimal dimensions designed the golden proportions. Taking its cue from the concept of 'encounter', it could be used singly or in multiple scenic compositions, in clusters or linear, which could be realised with specially designed canopies and accessories. The small conical die-cast aluminium head is available in matte black and bronze finishes; it conceals a LED source and a lens to direct the beam.

CODICE CODE	FONTI LUMINOSE LIGHT SOURCES	kg
-------------	------------------------------	----



BL08006.007.1719

BL08017.007.1719

Potenza assorbita apparecchio / Luminaire power consumption 2W

Flusso luminoso apparecchio / Luminaire luminous flux 95lm

2700K Ra>90 25° 48V DC dimmable (DALI)

IP20

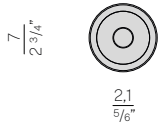
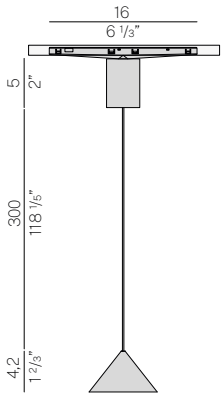

Compatibile con binario Street
Compatible with Street track

YLN08000.42

Lente per fascio largo (42°)
Wide flood lens (42°)

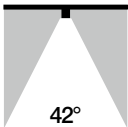

KGA08006.54

KGA08017.54

Kit con griglia antiabbagliamento in colore nero
Kit with anti-glare grid in black colour

0,05



Fotometrie disponibili www.panzeri.it / Photometric data available at www.panzeri.it

CODICI COLORI DISPONIBILI / COLOUR CODES AVAILABLE

06 nero satinato
matte black

17 bronzo
bronze



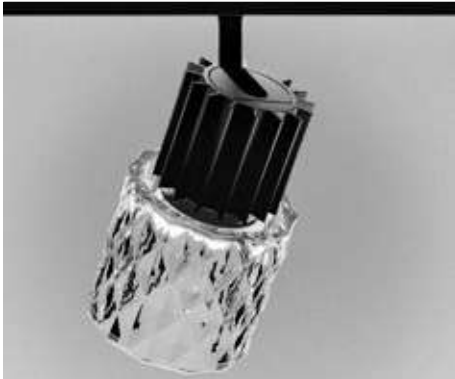

Scent unisce la precisione di un prodotto tecnico al calore di un oggetto d'arte. Il suo design trae ispirazione dall'estetica ricercata dei flaconi di profumo: le preziose sfaccettature del vetro a rilievo giocano con i riflessi, trasformando la luce in una materia viva che vibra nell'ambiente come una fragranza impalpabile. Disponibile come sospensione singola o nelle dinamiche versioni a binario, Scent permette di vestire ogni spazio con un'identità unica grazie a una palette cromatica concepita come vero strumento progettuale. Regala un comfort visivo assoluto e un'aura soffusa che, proprio come un profumo, lascia un'impronta invisibile ma memorabile.

Scent combines the precision of a technical product with the warmth of an artistic creation. Drawing inspiration from the sophisticated aesthetic of perfume bottles, its design features precious pressed glass facets that play with reflections, transforming light into living matter that vibrates within the space like an intangible fragrance. Available as a single suspension or in dynamic track versions, Scent enables any space to be adorned with a distinctive character through its curated colour palette. Providing absolute visual comfort, it emits a soft aura that leaves an invisible yet memorable imprint on the environment, much like a perfume.

NEW	CODICE CODE	FONTI LUM INOSE LIGHT SOURCES	kg
-----	-------------	-------------------------------	----

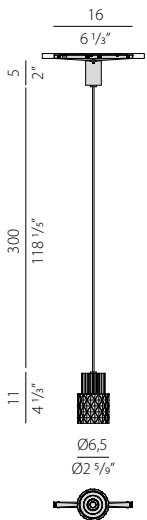

Compatibile con binario Street
Compatible with Street track



- BL30206.V17.1719
- BL30206.V08.1719
- BL30206.V13.1719
- BL30206.V15.1719
- BL30206.V14.1719
- BL30206.V04.1719
- BL30206.V09.1719
- BL30206.V10.1719
- BL30206.V16.1719

Potenza assorbita apparecchio / Luminaire power consumption 8,4W
Flusso luminoso apparecchio / Luminaire luminous flux 500lm
2700K Ra>90 24° 48V DC DALI

0,34

LED IP20



- BL30206.V17.2519
- BL30206.V08.2519
- BL30206.V13.2519
- BL30206.V15.2519
- BL30206.V14.2519
- BL30206.V04.2519
- BL30206.V09.2519
- BL30206.V10.2519
- BL30206.V16.2519

Potenza assorbita apparecchio / Luminaire power consumption 8,4W
Flusso luminoso apparecchio / Luminaire luminous flux 500lm
2700K Ra>90 24° 48V DC DALI

0,34

LED IP20

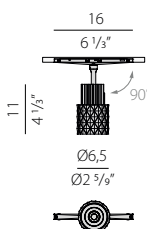

Compatibile con binario Street
Compatible with Street track



- B30206.V17.1719
- B30206.V08.1719
- B30206.V13.1719
- B30206.V15.1719
- B30206.V14.1719
- B30206.V04.1719
- B30206.V09.1719
- B30206.V10.1719
- B30206.V16.1719

Potenza assorbita apparecchio / Luminaire power consumption 8,4W
Flusso luminoso apparecchio / Luminaire luminous flux 500lm
2700K Ra>90 24° 48V DC DALI

0,29

LED IP20



- B30206.V17.2519
- B30206.V08.2519
- B30206.V13.2519
- B30206.V15.2519
- B30206.V14.2519
- B30206.V04.2519
- B30206.V09.2519
- B30206.V10.2519
- B30206.V16.2519

Potenza assorbita apparecchio / Luminaire power consumption 8,4W
Flusso luminoso apparecchio / Luminaire luminous flux 500lm
2700K Ra>90 24° 48V DC DALI







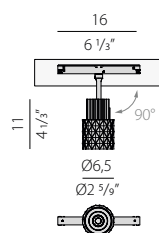

0,29

LED IP20

SCENT

Marc Sadler 2026



	CODICE CODE	FONTI LUM INOSE LIGHT SOURCES	kg
	B30106.V17.1719	Potenza assorbita apparecchio / Luminaire power consumption 8,4W	0,29
	B30106.V08.1719	Flusso luminoso apparecchio / Luminaire luminous flux 500lm	
	B30106.V13.1719	2700K Ra>90 24° 48V DC DALI	
	B30106.V15.1719	 IP20 	
	B30106.V14.1719		
	B30106.V04.1719		
	B30106.V09.1719		
	B30106.V10.1719		
	B30106.V16.1719		
	B30106.V17.2519	Potenza assorbita apparecchio / Luminaire power consumption 8,4W	
	B30106.V08.2519	Flusso luminoso apparecchio / Luminaire luminous flux 500lm	
	B30106.V13.2519	2700K Ra>90 24° 48V DC DALI	
	B30106.V15.2519	 IP20 	
	B30106.V14.2519		
	B30106.V04.2519		
	B30106.V09.2519		
	B30106.V10.2519		
	B30106.V16.2519		
	B30106.V17.2519		

Compatibile con binario Street
Compatible with Street track

Fotometrie disponibili www.panzeri.it / Photometric data available at www.panzeri.it

CODICI COLORI DISPONIBILI
COLOUR CODES AVAILABLE

COLORE VETRI
GLASSES COLOUR

06 nero satinato
matte black

V17 ghiaccio
ice

V08 trasparente
transparent

V13 rosa
pink

V15 arancione
orange

V14 caramello
caramel

V04 ambr
amber

V09 fumè
smoke grey

V10 verde foresta
forest green

V16 turchese
turquoise





Lampada a sospensione in alluminio estruso disponibile in ø 22mm o ø 32 mm e rispettive lunghezze 850mm/650mm. Sorgente luminosa composta da modulo LED ad elevate prestazioni CRI>90 2700K. Finitura con vernice poliacrilica in bianco, nero satinato, bronzo, ottone satinato o finitura in foglia oro decorata a mano.

Aluminum extruded suspension lamp in ø 22mm or ø 32mm diameter and respectively 850mm/650mm length. Light sources made of highly performing LED module with CRI>90 2700K. Finish in white, matte black, bronze, matte brass polyacrylic paint or hand-made decorated in golden leaf.

CODICE CODE	FONTI LUMINOSE LIGHT SOURCES	kg
-------------	------------------------------	----

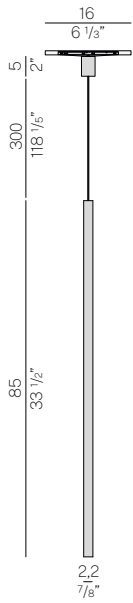

Compatibile con binario Street
Compatible with Street track

	BL02501.085.0419	Potenza assorbita apparecchio / Luminaire power consumption 4W
	BL02506.085.0419	Flusso luminoso apparecchio / Luminaire luminous flux 181lm
	BL02517.085.0419	2000K Ra>90 48V DC dimmable (DALI)
	BL02519.085.0419	IP20

	BL02501.085.0519	Potenza assorbita apparecchio / Luminaire power consumption 4W
	BL02506.085.0519	Flusso luminoso apparecchio / Luminaire luminous flux 181lm
	BL02517.085.0519	2700K Ra>90 48V DC dimmable (DALI)
	BL02519.085.0519	IP20

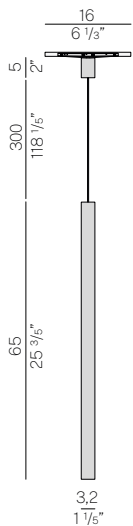

Compatibile con binario Street
Compatible with Street track

	BL02601.065.0419	Potenza assorbita apparecchio / Luminaire power consumption 7W
	BL02606.065.0419	Flusso luminoso apparecchio / Luminaire luminous flux 363lm
	BL02617.065.0419	2000K Ra>90 48V DC dimmable (DALI)
	BL02619.065.0419	IP20

	BL02601.065.0519	Potenza assorbita apparecchio / Luminaire power consumption 7W
	BL02606.065.0519	Flusso luminoso apparecchio / Luminaire luminous flux 363lm
	BL02617.065.0519	2700K Ra>90 48V DC dimmable (DALI)
	BL02619.065.0519	IP20

Fotometrie disponibili www.panzeri.it / Photometric data available at www.panzeri.it

CODICI COLORI DISPONIBILI / COLOUR CODES AVAILABLE

- 01** bianco white
- 06** nero satinato matte black
- 17** bronzo bronze
- 19** ottone satinato matte brass





STREET 8



Proiettore orientabile in pressofusione di alluminio con LED ad alta efficienza e adattatore integrato, per binario elettrificato a bassissima tensione 48V. Completo di cilindro antiabbagliamento e lente con fascio medio in materiale termoplastico. Disponibile in versione 2700K e 3000K, in finitura bianco, nero, ottone satinato, bronzo e titanio, con braccio e cover posteriore in colore nero.

Die-cast aluminium adjustable spotlight with high efficiency LED and integrated adapter for 48V low voltage electrified track. Complete with anti-glare snoot and thermoplastic medium-beam lens. Available in 2700K and 3000K version, in white, black, matte brass, bronze and titanium finishes, with black arm and back cover.

CODICE CODE	FONTI LUMINOSE LIGHT SOURCES	kg
B42401.008.1719	Potenza assorbita apparecchio / Luminaire power consumption 15W	0,23
B42402.008.1719	Flusso luminoso apparecchio / Luminaire luminous flux 1100lm	
B42417.008.1719	2700K Ra>90 24° 48V DC dimmable (DALI)	
B42419.008.1719	IP20	
B42401.008.2519	Potenza assorbita apparecchio / Luminaire power consumption 15W	0,23
B42402.008.2519	Flusso luminoso apparecchio / Luminaire luminous flux 1100lm	
B42417.008.2519	3000K Ra>90 24° 48V DC dimmable (DALI)	
B42419.008.2519	IP20	

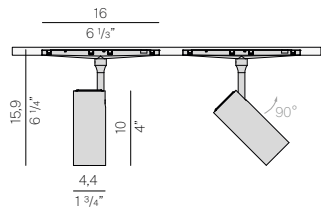

Compatibile con binario Street
Compatible with Street track

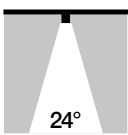

STANDARD

Lente per fascio medio.
Flood lens.

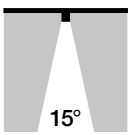

YLN43400.15

Lente per fascio stretto.
Spot lens.

0,01

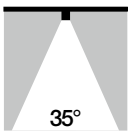

YLN43400.35

Lente per fascio medio.
Flood lens.

0,01

Fotometrie disponibili www.panzeri.it / Photometric data available at www.panzeri.it

CODICI COLORI DISPONIBILI / COLOUR CODES AVAILABLE

- 01** bianco
white
- 02** nero
black
- 17** bronzo
bronze
- 19** ottone satinato
matte brass





STREET 5



Proiettore orientabile in pressofusione di alluminio con LED ad alta efficienza e adattatore integrato, per binario elettrificato a bassissima tensione 48V. Completo di cilindro antiabbagliamento e lente con fascio medio in materiale termoplastico. Disponibile in versione 2700K e 3000K, in finitura bianco, nero, ottone satinato, bronzo e titanio, con braccio e cover posteriore in colore nero.

Die-cast aluminium adjustable spotlight with high efficiency LED and integrated adapter for 48V low voltage electrified track. Complete with anti-glare snoot and thermoplastic medium-beam lens. Available in 2700K and 3000K version, in white, black, matte brass, bronze and titanium finishes, with black arm and back cover.

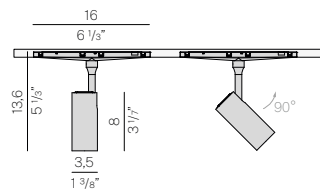

CODICE CODE	FONTE LUMINOSA LIGHT SOURCES	kg
B42301.005.1719	Potenza assorbita apparecchio / Luminaire power consumption 8,4W	0,16
B42302.005.1719	Flusso luminoso apparecchio / Luminaire luminous flux 590lm	
B42317.005.1719	2700K Ra>90 24° 48V DC dimmable (DALI)	
B42319.005.1719	IP20	
B42301.005.2519	Potenza assorbita apparecchio / Luminaire power consumption 8,4W	0,16
B42302.005.2519	Flusso luminoso apparecchio / Luminaire luminous flux 590lm	
B42317.005.2519	3000K Ra>90 24° 48V DC dimmable (DALI)	
B42319.005.2519	IP20	

Compatibile con binario Street
Compatible with Street track

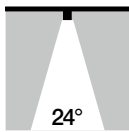

STANDARD

Lente per fascio medio.
Flood lens.

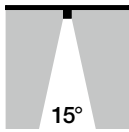

YLN43400.15

Lente per fascio stretto.
Spot lens.

0,01

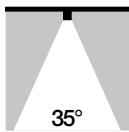

YLN43400.35

Lente per fascio medio.
Flood lens.

0,01

Fotometrie disponibili www.panzeri.it / Photometric data available at www.panzeri.it

CODICI COLORI DISPONIBILI / COLOUR CODES AVAILABLE

- | | | | |
|---------------------------|-------------------------|----------------------------|--|
| 01 bianco
white | 02 nero
black | 17 bronzo
bronze | 19 ottone satinato
matte brass |
|---------------------------|-------------------------|----------------------------|--|





STREET 3



Proiettore orientabile in pressofusione di alluminio con LED ad alta efficienza e adattatore integrato, per binario elettrificato a bassissima tensione 48V. Completo di cilindro antiabbagliamento e lente con fascio medio in materiale termoplastico. Disponibile in versione 2700K e 3000K, in finitura bianco, nero, ottone satinato, bronzo e titanio, con braccio e cover posteriore in colore nero.

Die-cast aluminium adjustable spotlight with high efficiency LED and integrated adapter for 48V low voltage electrified track. Complete with anti-glare snoot and thermoplastic medium-beam lens. Available in 2700K and 3000K version, in white, black, matte brass, bronze and titanium finishes, with black arm and back cover.

CODICE CODE	FONTI LUMINOSE LIGHT SOURCES	kg
B42201.003.1719	Potenza assorbita apparecchio / Luminaire power consumption 7,2W	0,13
B42202.003.1719	Flusso luminoso apparecchio / Luminaire luminous flux 447lm	
B42217.003.1719	2700K Ra>90 24° 48V DC dimmable (DALI)	
B42219.003.1719	IP20	
B42201.003.2519	Potenza assorbita apparecchio / Luminaire power consumption 7,2W	0,13
B42202.003.2519	Flusso luminoso apparecchio / Luminaire luminous flux 447lm	
B42217.003.2519	3000K Ra>90 24° 48V DC dimmable (DALI)	
B42219.003.2519	IP20	

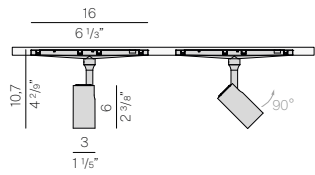

Compatibile con binario Street
Compatible with Street track

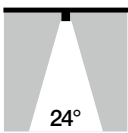

STANDARD

Lente per fascio medio.
Flood lens.

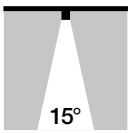

YLN43400.15

Lente per fascio stretto.
Spot lens.

0,01

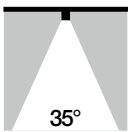

YLN43400.35

Lente per fascio medio.
Flood lens.

0,01

Fotometrie disponibili www.panzeri.it / Photometric data available at www.panzeri.it

CODICI COLORI DISPONIBILI / COLOUR CODES AVAILABLE

01 bianco white **02** nero black **17** bronzo bronze **19** ottone satinato matte brass





STREET LINE



Modulo lineare a luce diffusa per binario elettrificato a bassissima tensione 48V per applicazioni soffitto/parete, sospensione e incasso, con corpo in poliammide in colore nero e schermo in policarbonato estruso opale. Possibilità di dimmerazione tramite protocollo DALI.

Linear LED module for 48V low voltage electrified track, for ceiling/wall, suspended or recessed applications. Black polyamide body, opal diffuser made in extruded polycarbonate. Possibility of dimming with DALI protocol.

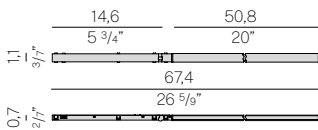

CODICE CODE	FONTI LUMINOSE LIGHT SOURCES	kg
B42102.060.0519	Potenza assorbita apparecchio / Luminaire power consumption 7,4W Flusso luminoso apparecchio / Luminaire luminous flux 429lm 2700K Ra>90 48V DC dimmable (DALI) IP20	0,04
B42102.060.0419	Potenza assorbita apparecchio / Luminaire power consumption 7,4W Flusso luminoso apparecchio / Luminaire luminous flux 429lm 3000K Ra>90 48V DC dimmable (DALI) IP20	0,04

Compatibile con binario Street
Compatible with Street track

Fotometrie disponibili www.panzeri.it / Photometric data available at www.panzeri.it

CODICI COLORI DISPONIBILI / COLOUR CODES AVAILABLE

02 nero
black



STREET SPOT



Modulo di luce lineare per binario elettrificato a bassissima tensione 48V per applicazioni soffitto/parete, sospensione e incasso. Corpo in poliammide in colore nero, lenti con fascio 30° in policarbonato e copertura in materiale plastico. Possibilità di dimmerazione tramite protocollo DALI.

Linear LED module for 48V low voltage electrified track, for ceiling/wall, suspended or recessed applications. Black polyamide body, 30° beam polycarbonate lens and plastic cover. Possibility of dimming with DALI protocol.

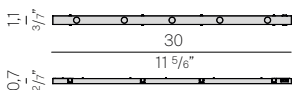

CODICE CODE	FONTI LUMINOSE LIGHT SOURCES	kg
B42002.030.1719	Potenza assorbita apparecchio / Luminaire power consumption 4,9W Flusso luminoso apparecchio / Luminaire luminous flux 318lm 2700K Ra>90 34° 48V DC dimmable (DALI) IP20	0,03
B42002.030.2519	Potenza assorbita apparecchio / Luminaire power consumption 4,9W Flusso luminoso apparecchio / Luminaire luminous flux 318lm 3000K Ra>90 34° 48V DC dimmable (DALI) IP20	0,03

Compatibile con binario Street
Compatible with Street track

Fotometrie disponibili www.panzeri.it / Photometric data available at www.panzeri.it

CODICI COLORI DISPONIBILI / COLOUR CODES AVAILABLE

02 nero
black

Murané
BP11_05.010



Murané
BP11_05.015



432 Ways
BP127__006
+YSL127__006.FL



Scent
B30206.V__

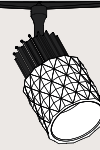

Murané
BL11_05.010



Murané
BL11_05.015



432 Ways
BL127__006
+YSL127__006.FL



Scent
BL30206.V__



Bella
BL053__011

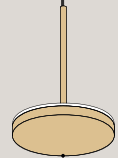

Street Line
B421__060

Street Spot
B420__030

Street 3
B422__003

Street 5
B423__005

Street 8
B424__008

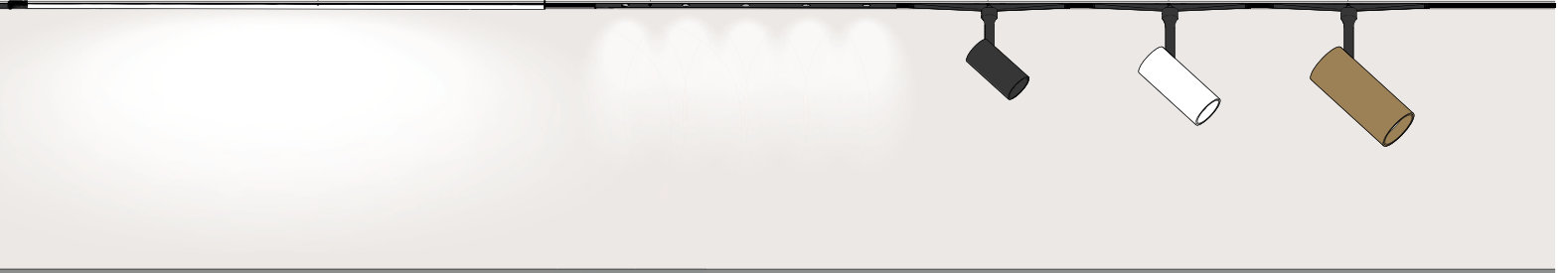

Bella
BL052__011

To-Be
BL026__065

To-Be
BL025__085

Rendez-vous
BL080__007

STREET IN



Sistema di binari a bassissima tensione 48V per applicazioni ad incasso. Binario a sezione rettangolare in alluminio estruso anodizzato nero o bianco, predisposto per alloggiare proiettori, moduli luminosi e una vasta gamma di sospensioni decorative provviste di adattatore 48V. Possibilità di regolazione DALI. Disponibile un'ampia varietà di accessori e giunti di collegamento.

System of 48V low voltage electrified tracks for recessed applications. Square-shaped track made of black or white anodised extruded aluminium, suitable to host spotlights, linear light modules and a wide range of decorative suspensions equipped with 48V adapters. Possibility of DALI dimming. Wide range of available accessories and joints.

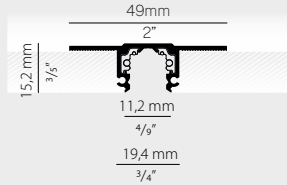

TRIMLESS RECESSED ELECTRIFIED TRACK 48V DC

IP20 850°

CODICE / CODE	L MM	L INCHES	kg
9600-1/B-ST5	1000mm	39 3/5"	1,25
9600-2/B-ST5	2000mm	78 4/5"	2,50
9600-3/B-ST5	3000mm	118 1/5"	3,75

CODICI COLORI DISPONIBILI / COLOUR CODES AVAILABLE

/B nero
black

ACCESSORI / ACCESSORIES

S-9600/B-E-3000

Copertura estetica di lunghezza 3000mm (118,1") per binario elettrificato 48V DC a incasso nero.
Aesthetic cover for recessed 48V DC electrified track, length 3000mm (118,1"), black.

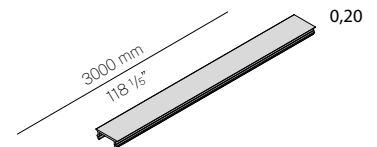

9601-S/B

Alimentazione di testa integrata per binario elettrificato 48V DC DALI, con cavo di alimentazione di lunghezza 2500mm nero.
Integrated head supply for 48V DC DALI electrified track, with 2500mm long power cable black.

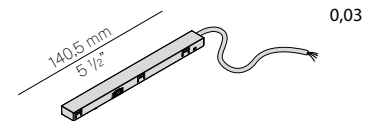

9603/B

Giunto lineare elettrificato per binario 48V DC DALI nero.
Linear electrified joint for 48V DC DALI track black.

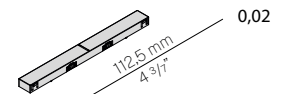

9604/ST5-B

Testata di chiusura per binario elettrificato 48V DC a incasso nero.
End cap for recessed 48V DC electrified track black.

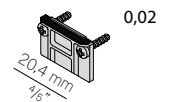

YRS.B048.A16

Dispositivo ripetitore per optoisolare il bus data, per binario elettrificato 48V DC DALI. **ACCESSORIO OBBLIGATORIO.**
Repeater device for opto-isolating the data bus, for 48V DC DALI electrified track. **MANDATORY ACCESSORY.**

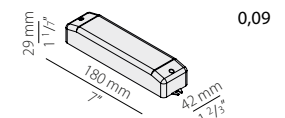

YDV.048.075.A01

Alimentatore LED, 75W 48V DC, on/off.
LED driver, 75W 48V DC, on/off.

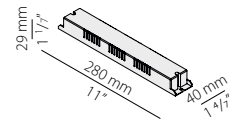

0,23

YDV.048.150.A01

Alimentatore LED, 150W 48V DC, on/off.
LED driver, 150W 48V DC, on/off.

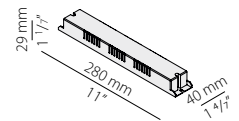

0,25

STREET TRACK COLLECTION COMPONENTS

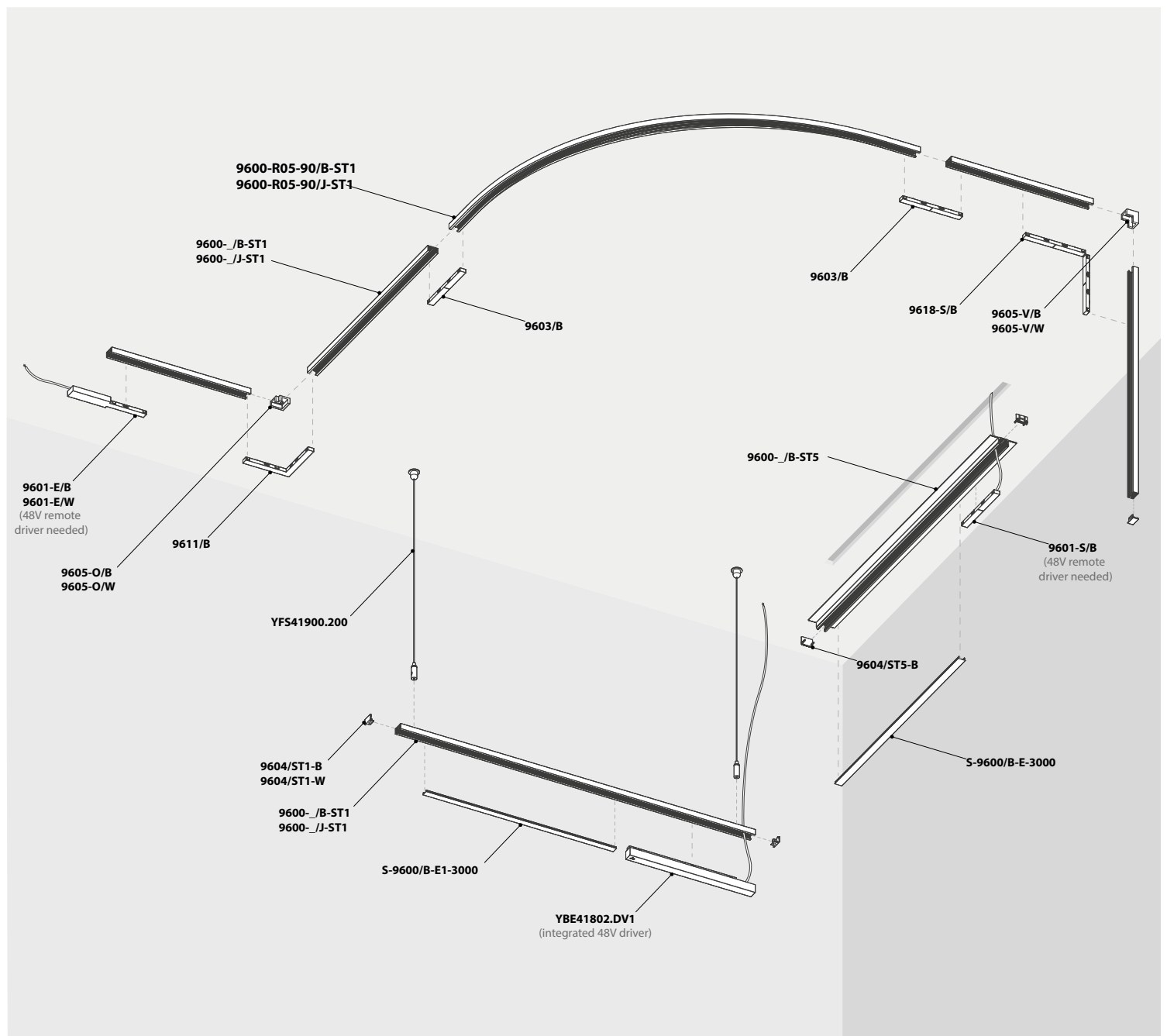

STREET OUT



Sistema di binari a bassissima tensione 48V per installazioni a soffitto/parete o sospensione. Binario a sezione rettangolare in alluminio estruso anodizzato nero o bianco con interno nero, predisposto per alloggiare proiettori, moduli luminosi e una vasta gamma di sospensioni decorative provviste di adattatore 48V. Possibilità di regolazione DALI. Disponibile un'ampia varietà di accessori e giunti di collegamento.

System of 48V low voltage electrified tracks for ceiling/wall or suspeded applications. Square-shaped track made of black or white with black interior anodised extruded aluminium, suitable to host spotlights, linear light modules and a wide range of decorative suspensions equipped with 48V adapters. Possibility of DALI dimming. Wide range of available accessories and joints.



ELECTRIFIED TRACK 48V DC



CODICE / CODE	L MM	L INCHES	kg
9600-1/B-ST1	1000mm	39 3/8"	1,00
9600-1/J-ST1	1000mm	39 3/8"	1,00
9600-2/B-ST1	2000mm	78 4/8"	2,00
9600-2/J-ST1	2000mm	78 4/8"	2,00
9600-3/B-ST1	3000mm	118 1/8"	3,00
9600-3/J-ST1	3000mm	118 1/8"	3,00

CODICI COLORI DISPONIBILI / COLOUR CODES AVAILABLE

B nero
black

J bianco con interno nero
white with black inner

ACCESSORI / ACCESSORIES

9600-R05-90/B-ST1

Curva a 90° per binario elettrificato 48V DC DALI a sospensione o plafone, nero, raggio 500mm (19,7").
90° curve for suspended or ceiling-mounted 48V DC DALI electrified track, black, 500mm (19.7") radius.

9600-R05-90/J-ST1

Curva a 90° per binario elettrificato 48V DC DALI a sospensione o plafone, bianco, interno nero, raggio 500mm (19,7").
90° curve for suspended or ceiling-mounted 48V DC DALI electrified track, white, black interior, 500mm (19.7") radius.



kg

1,00

1,00

S-9600/B-E1-3000

Copertura estetica di lunghezza 3000mm (118,1") per binario elettrificato 48V DC, nero.
Aesthetic cover for 48V DC electrified track, length 3000mm (118,1"), black.

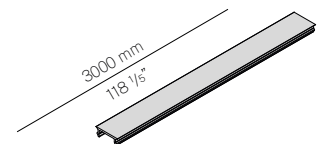

0,20

9601-E/B

Alimentazione di testa per binario elettrificato 48V DC DALI, nero.
Head power supply for 48V DC DALI electrified track, black.

9601-E/W

Alimentazione di testa per binario elettrificato 48V DC DALI, bianco.
Head power supply for 48V DC DALI electrified track, white.

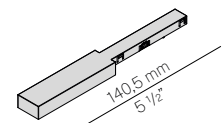

0,03

0,03

ACCESSORI / ACCESSORIES

	kg
<p>9601-S/B Alimentazione di testa integrata per binario elettrificato 48V DC DALI, con cavo di alimentazione di lunghezza 2500mm, nero. Integrated head power supply for 48V DC DALI electrified track, with 2500mm long power cable, black.</p>	1,50
<p>9603/B Giunto lineare elettrificato per binario 48V DC DALI nero. Linear electrified joint for 48V DC DALI track black.</p>	0,02
<p>9605-O/B Coprigiunto a "L" per binario elettrificato 48V DC a plafone, nero. L-shaped junction cover for ceiling-mounted 48V DC electrified track, black.</p>	0,20
<p>9605-O/W Coprigiunto a "L" per binario elettrificato 48V DC a plafone, bianco. L-shaped junction cover for ceiling-mounted 48V DC electrified track, white.</p>	0,02
<p>9605-V/B Coprigiunto a "L" per angolo parete-soffitto per binario elettrificato 48V DC a plafone, nero. L-shaped junction cover for wall-ceiling corner for ceiling-mounted 48V DC electrified track, black.</p>	0,20
<p>9605-V/W Coprigiunto a "L" per angolo parete-soffitto per binario elettrificato 48V DC a plafone, bianco. L-shaped junction cover for wall-ceiling corner for ceiling-mounted 48V DC electrified track, white.</p>	0,02
<p>9611/B Giunto elettrificato a "L" per binario 48V DC DALI nero. Electrified "L" joint for 48V DC DALI track black.</p>	0,06
<p>9618-S/B Giunto elettrificato flessibile per binario 48V DC DALI. Flexible electrified joint for 48V DC DALI track.</p>	0,07
<p>9604/ST1-B Testata di chiusura per binario elettrificato 48V DC, nero. End cap for 48V DC electrified track, black.</p>	0,02
<p>9604/ST1-W Testata di chiusura per binario elettrificato 48V DC, bianco. End cap for 48V DC electrified track, white.</p>	0,02
<p>YKS41900.01 Kit sospensione con fune di acciaio di lunghezza 2000mm e regolatore (78,7") per binario elettrificato, utilizzare uno ogni 450mm. Suspension kit with 2000mm (78,7") long steel wire and regulator, for electrified track, one every 450mm</p>	0,05
<p>YBE41902.DV1 Alimentatore integrato per binario elettrificato 48V DC, 50W, on/off, con n.2 cavi aggiuntivi per cablaggio passante DALI, nero. Integrated 50W on/off power supply for electrified 48V track, with 2 additional cables for DALI feed-through wiring, black</p>	0,15
<p>YRS.B048.A16 Dispositivo ripetitore per optoisolare il bus data, per binario elettrificato 48V DC DALI. ACCESSORIO OBBLIGATORIO Repeater device for opto-isolating the data bus, for 48V DC DALI electrified track. MANDATORY ACCESSORY</p>	0,09
<p>YDV.048.075.A01 Alimentatore LED, 75W 48V DC, on/off. LED driver, 75W 48V DC, on/off.</p>	0,23
<p>YDV.048.150.A01 Alimentatore LED, 150W 48V DC, on/off. LED driver, 150W 48V DC, on/off.</p>	0,25

INCASSI / RECESSED

189 **CLICK CLACK**
190 **EAST**
193 **EDDIE**
194 **JAMES**
195 **JARVIS**
196 **JESSIE**
203 **JOE**
192 **MOAI**
197 **NICK**
199 **RALLY TRIM**
201 **SID**
202 **TAYLOR**



CLICK CLACK

Enzo Panzeri 2019



Click clack è un incasso in gesso con un foro di 35mm. Garantisce massima praticità grazie ad uno speciale meccanismo "push&pull" che consente il ribassamento del portalamпада per la sostituzione della sorgente luminosa, evitando invasivi interventi di manutenzione.

Click clack is a plaster recessed fitting with a 35mm hole. It guarantees maximum functionality thanks to a special push&pull mechanism that allows the lamp holder to be lowered to replace the light source, avoiding invasive maintenance operations.



XGR1212
XM3 lampholder with terminal block
LED retrofit bulb 4W GU10 Ø 35mm 3000K Ra80 330lm (no dimming)

IP20

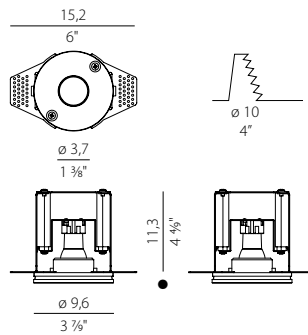

+ Electric options
(see details on page 205)

XM5/GU10-35 retrofit lamp

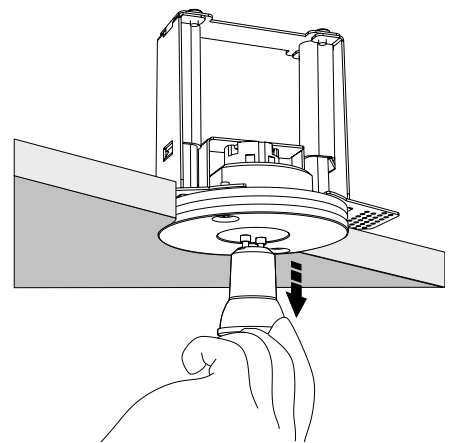
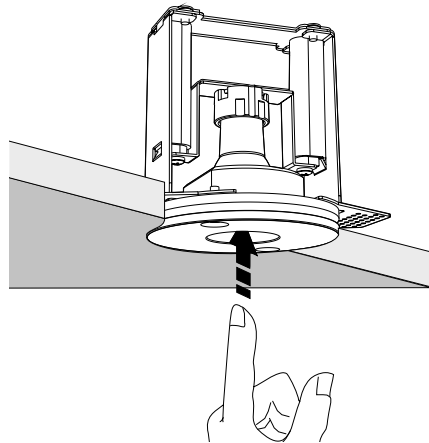

- Minima altezza di ingombro dell'apparecchio (le quote minime del vano di incasso sono riportate sul foglio di istruzioni)

Minimum height of the appliance (see the minimum values for housing compartment in the instruction sheets)

Lampadina non inclusa, vedi electric options.
Da acquistare separatamente.

Bulb not included, see electric options.
Please purchase separately.

Fotometrie disponibili www.panzeri.it / Photometric data available at www.panzeri.it

CODICI COLORI DISPONIBILI / COLOUR CODES AVAILABLE

42 gesso
plaster



EAST



Incassi in gesso fissi o orientabili. I prodotti sono venduti con alimentazione di serie GU10. Le elettrificazioni opzionali e i relativi driver sono forniti separatamente al prodotto e vanno eventualmente sostituiti a quelli di serie.

Fixed or adjustable plaster recessed luminaires. The products are sold with GU10 fittings. Different types of electricity supply and the related drivers substitute the series fitting.



XGR0997

XM3 lampholder with terminal block max 50W GU10

IP20

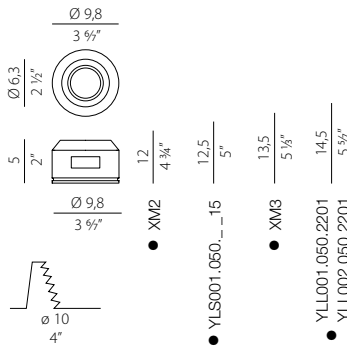

+ Electric options

(see details on page 205)

LAMP

YLL001.050.2201 retrofit lamp
YLL002.050.2201 retrofit lamp
YLS001.050._.15 spot LED
XM2 lampholder with terminal block

DRIVER

XM6-15 UNI
XM6-20 UNI ★
XM6-20 D/P MULTI ★
XM6-25 D/P MULTI

kg

0,24



XGQ0998

XM3 lampholder with terminal block max 50W GU10

IP20

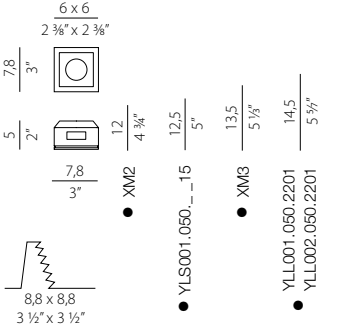

+ Electric options

(see details on page 205)

LAMP

YLL001.050.2201 retrofit lamp
YLL002.050.2201 retrofit lamp
YLS001.050._.15 spot LED
XM2 lampholder with terminal block

DRIVER

XM6-15 UNI
XM6-20 UNI ★
XM6-20 D/P MULTI ★
XM6-25 D/P MULTI

0,17

XM0998 85x85x155mm

Cassaforma per incasso in muratura in lamiera zincata.

Gruppo di alimentazione da prevedere remoto esternamente alla cassaforma.

Galvanized sheet housing to be recessed in brick wall or concrete.

Electrical power supply must be remote outside of the housing.

0,45

I prodotti sono venduti con cablaggio di serie GU10. Le elettrificazioni opzionali sono fornite separatamente al prodotto e vanno perciò sostituite a quelle di serie.

The products are sold with GU10 fittings. Different types of electric options are supplied separately and substitute the series fitting.

- Minima altezza di ingombro dell'apparecchio (le quote minime del vano di incasso sono riportate sul foglio di istruzioni) Minimum height of the appliance (see the minimum values for housing compartment in the instruction sheets)
- ★ Dimensione dell'alimentatore maggiore del foro d'incasso, dunque installare l'alimentatore in apposito vano d'ispezione. Power supply unit is larger than the recess hole, install the power supply unit in a special inspection compartment.

**XGQ0998-GL**

XM3 lampholder with terminal block max 50W GU10

IP20

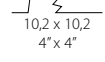
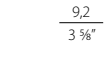
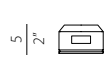
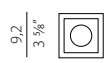
$$\frac{6 \times 6}{2 \frac{3}{8}'' \times 2 \frac{3}{8}''}$$

● XM2 $\frac{12}{4 \frac{3}{4}''}$

● YLS001.050._15 $\frac{12.5}{5''}$

● XM3 $\frac{13.5}{5 \frac{1}{2}''}$

● YLL001.050.2201 $\frac{14.5}{5 \frac{9}{16}''}$

● YLL002.050.2201 $\frac{14.5}{5 \frac{9}{16}''}$

+ Electric options

(see details on page 205)

LAMP

YLL001.050.2201 retrofit lamp

YLL002.050.2201 retrofit lamp

YLS001.050._15 spot LED

XM2 lampholder with terminal block

DRIVER

XM6-15 UNI

XM6-20 UNI *

XM6-20 D/P MULTI *

XM6-25 D/P MULTI

0,33

XM0998-GL 95x95x155mm

Cassaforma per incasso in muratura in lamiera zincata.

Gruppo di alimentazione da prevedere remoto esternamente alla cassaforma.

Galvanized sheet housing to be recessed in brick wall or concrete.

Electrical power supply must be remote outside of the housing.

0,52

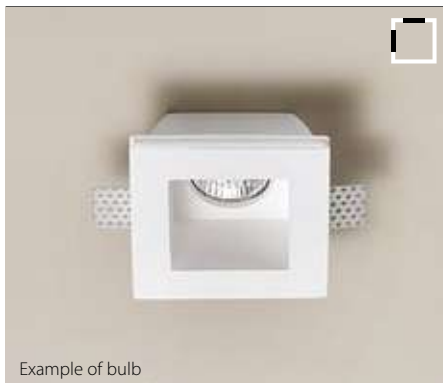

Example of bulb

XGQ1004

XM3 lampholder with terminal block max 50W GU10

IP20

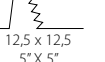
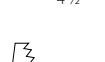
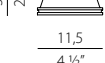
$$\frac{7 \times 7}{2 \frac{3}{4}'' \times 2 \frac{3}{4}''}$$

● XM2 $\frac{11.5}{4 \frac{1}{2}''}$

● YLS001.050._15 $\frac{13.5}{5 \frac{1}{8}''}$

● XM3 $\frac{13.5}{5 \frac{1}{8}''}$

● YLL001.050.2201 $\frac{14.5}{5 \frac{9}{16}''}$

● YLL002.050.2201 $\frac{14.5}{5 \frac{9}{16}''}$

+ Electric options

(see details on page 205)

LAMP

YLL001.050.2201 retrofit lamp

YLL002.050.2201 retrofit lamp

YLS001.050._15 spot LED

XM2 lampholder with terminal block

DRIVER

XM6-15 UNI

XM6-20 UNI *

XM6-20 D/P MULTI *

XM6-25 D/P MULTI

0,46

XGQ1004-GL

XM3 lampholder with terminal block max 50W GU10

IP20

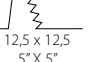
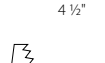
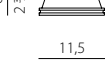
$$\frac{7 \times 7}{2 \frac{3}{4}'' \times 2 \frac{3}{4}''}$$

● XM2 $\frac{12}{4 \frac{3}{4}''}$

● YLS001.050._15 $\frac{14}{5 \frac{1}{2}''}$

● XM3 $\frac{14}{5 \frac{1}{2}''}$

● YLL001.050.2201 $\frac{15}{6''}$

● YLL002.050.2201 $\frac{15}{6''}$

+ Electric options

(see details on page 205)

LAMP

YLL001.050.2201 retrofit lamp

YLL002.050.2201 retrofit lamp

YLS001.050._15 spot LED

XM2 lampholder with terminal block

DRIVER

XM6-15 UNI

XM6-20 UNI *

XM6-20 D/P MULTI *

XM6-25 D/P MULTI

0,56

XM1004/1004-GL/1030 125x125x155mm

Cassaforma per incasso in muratura in lamiera zincata.

Gruppo di alimentazione da prevedere remoto esternamente alla cassaforma.

Galvanized sheet housing to be recessed in brick wall or concrete.

Electrical power supply must be remote outside of the housing.

0,71

I prodotti sono venduti con cablaggio di serie GU10.

Le elettrificazioni opzionali sono fornite separatamente al prodotto e vanno perciò sostituite a quelle di serie.

The products are sold with GU10 fittings.

Different types of electric options are supplied separately and substitute the series fitting.

- Minima altezza di ingombro dell'apparecchio (le quote minime del vano di incasso sono riportate sul foglio di istruzioni)

Minimum height of the appliance (see the minimum values for housing compartment in the instruction sheets)

- * Dimensione dell'alimentatore maggiore del foro d'incasso, dunque installare l'alimentatore in apposito vano d'ispezione.

Power supply unit is larger than the recess hole, install the power supply unit in a special inspection compartment.



MOAI



Wall washer in gesso predisposto per la rasatura totale, con sorgente luminosa LED arretrata.

Plaster wall washer prepared for total flush, with recessed LED light source.



XGQ1210.0401

Potenza assorbita apparecchio / Luminaire power consumption 15W
Flusso luminoso apparecchio / Luminaire luminous flux 1063lm
3000K Ra>90 220-240V AC ON-OFF

kg

2,01

XGQ1210.0402

Potenza assorbita apparecchio / Luminaire power consumption 15W
Flusso luminoso apparecchio / Luminaire luminous flux 1063lm
3000K Ra>90 220-240V AC dimmable (DALI/Push DIM)

2,01

 IP20

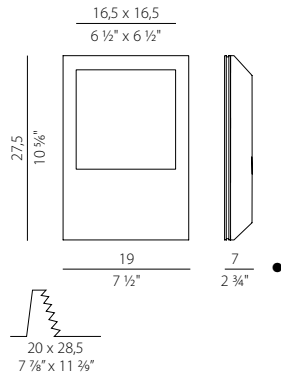

XM1210 325x195x75mm

Cassaforma per incasso in muratura in lamiera zincata.
Galvanized sheet housing to be recessed in brick wall or concrete.

1,00

- Minima altezza di ingombro dell'apparecchio (le quote minime del vano di incasso sono riportate sul foglio di istruzioni) Minimum height of the appliance (see the minimum values for housing compartment in the instruction sheets)

Fotometrie disponibili www.panzeri.it / Photometric data available at www.panzeri.it

CODICI COLORI DISPONIBILI / COLOUR CODES AVAILABLE

42 gesso
plaster

21 foglia oro (a richiesta)
gold leaf (available on request)





EDDIE



Piccolo faretto in alluminio ad emissione diretta per installazione ad incasso in ambienti interni. Diametro 30mm, sottilissima cornice a vista, sorgente luminosa arretrata. Disponibile in finitura bianco o nero.

Small direct-emitting aluminium spotlight for recessed indoor installations. Diameter 30 mm, recessed light source, very thin visible frame. Available in white or black finishes.



XR17201.030.1715

XR17202.030.1715

Potenza assorbita apparecchio / Luminaire power consumption 2,1W
Flusso luminoso apparecchio / Luminaire luminous flux 194lm
2700K Ra>90 25° 700mA DC

IP20

XR17201.030.2515

XR17202.030.2515

Potenza assorbita apparecchio / Luminaire power consumption 2,1W
Flusso luminoso apparecchio / Luminaire luminous flux 194lm
3000K Ra>90 25° 700mA DC

IP20

+ Electric options
(see details on page 206)

DRIVER
YDA.070.012.A01 ★
YDR.090.013.A02 ★

kg

0,05

0,05

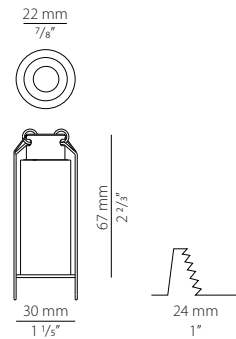

★ Dimensione dell'alimentatore maggiore del foro d'incasso, dunque installare l'alimentatore in apposito vano d'ispezione.

Power supply unit is larger than the recess hole, install the power supply unit in a special inspection compartment.

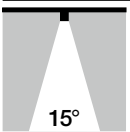

YLN17200.15

Lente per fascio stretto.
Spot optic

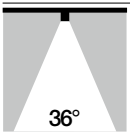

YLN17200.36

Lente per fascio medio.
Flood optic.

Fotometrie disponibili www.panzeri.it / Photometric data available at www.panzeri.it

CODICI COLORI DISPONIBILI / COLOUR CODES AVAILABLE

01 bianco
white **02** nero
black





JAMES



Faretto ad incasso ad emissione diretta con fascio 24° in alluminio pressofuso per ambienti interni con controsoffitto. Sorgente luminosa arretrata con possibilità di orientamento del fascio di luce, fino ad un angolo massimo di 30°. Grado di protezione IP44, impermeabile agli schizzi. Disponibile in finitura bianco o nero.

Die-casted aluminium recessed spotlight with direct emission and 24° beam angle, for indoor application in false ceiling. Recessed light source with the possibility of orienting the light beam up to a maximum angle of 30°. IP44 protection degree, splash-proof. Available in white or black finishes.



XR17701.040.1715

XR17702.040.1715

Potenza assorbita apparecchio / Luminaire power consumption 5,2W
Flusso luminoso apparecchio / Luminaire luminous flux 465lm
2700K Ra>90 24° 300mA DC

IP44

XR17701.040.2515

XR17702.040.2515

Potenza assorbita apparecchio / Luminaire power consumption 5,2W
Flusso luminoso apparecchio / Luminaire luminous flux 465lm
3000K Ra>90 24° 300mA DC

IP44

+ Electric options

(see details on page 206)

DRIVER

YDR.035.008.A01

YDR.035.008.A02

kg

0,13

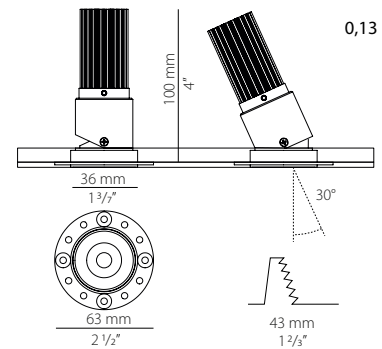

0,13

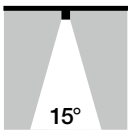

15°

YLN17700.15

Lente per fascio stretto.
Spot optic.

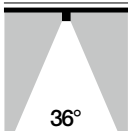

36°

YLN17700.36

Lente per fascio medio.
Flood optic.



YGA17700.23

Griglia anti-abbagliamento in colore nero.
Anti-glare grid in black colour.

Fotometrie disponibili www.panzeri.it / Photometric data available at www.panzeri.it

CODICI COLORI DISPONIBILI / COLOUR CODES AVAILABLE

01 bianco
white

02 nero
black



JARVIS



Faretti in alluminio per installazione incassata con cornice a vista ed emissione simmetrica, oppure per incasso a scomparsa con fascio orientabile.
Disponibili con finitura interna bianca o nera satinata, con o senza sorgente LED GU10. Possibilità di installare sorgente spot LED.

Aluminium downlights for recessed use with visible frame and symmetric light emission, or fully recessed with adjustable beam.
Inside part available in white or matte black, with or without GU10 LED lamp. Spot LED available.



XR13001.070.2201

XR13006.070.2201

XM3 lampholder with terminal block max 10W GU10
LED retrofit bulb 7,5W GU10 3000K 60° Ra80 608lm (no dimming)
Lampadina inclusa / Included bulb

IP20

XR13001.070.0000

XR13006.070.0000

XM3 lampholder with terminal block max 10W GU10
senza lampadina /
without bulb

IP20

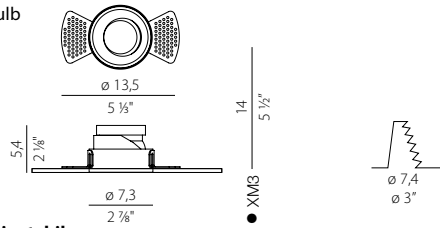

Faretto orientabile
Adjustable spot



kg

0,19

0,15

+ Electric options

(see details on page 205)

LAMP

YLS005.050.__15 spot LED

XM2 lampholder with terminal block

DRIVER

XM6-20 UNI

YDR.035.012.A02



XR13101.085.2201

XR13106.085.2201

XM3 lampholder with terminal block max 10W GU10
LED retrofit bulb 7,5W GU10 3000K 60° Ra80 608lm (no dimming)
Lampadina inclusa / Included bulb

IP20

XR13101.085.0000

XR13106.085.0000

XM3 lampholder with terminal block max 10W GU10
senza lampadina /
without bulb

IP20

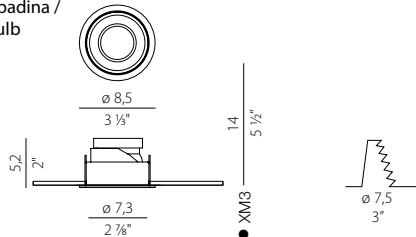

Faretto fisso
Fixed spot



0,17

0,13

+ Electric options

(see details on page 205)

LAMP

YLS005.050.__15 spot LED

XM2 lampholder with terminal block

DRIVER

XM6-20 UNI

YDR.035.012.A02

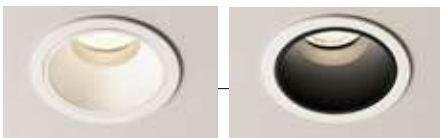

● Minima altezza di ingombro dell'apparecchio (le quote minime del vano di incasso sono riportate sul foglio di istruzioni)

Minimum height of the appliance (see the minimum values for housing compartment in the instruction sheets)

Fotometrie disponibili www.panzeri.it / Photometric data available at www.panzeri.it

CODICI COLORI DISPONIBILI / COLOUR CODES AVAILABLE

01 bianco
white

06 nero satinato
matte black



JESSIE



Faretto ad incasso ad emissione diretta con fascio 24° in alluminio pressofuso per ambienti interni. La struttura si presta per l'installazione in controsoffitti con altezze ridotte, min. 70mm (2,8"). Sorgente luminosa arretrata. Disponibile in finitura bianco o nero.

Die-casted aluminium recessed spotlight with direct emission and 24° beam angle, for indoor application. The structure lends itself to installations in low false ceiling heights, min. 70mm (2,8"). Recessed light source. Available in white or black finishes.

kg

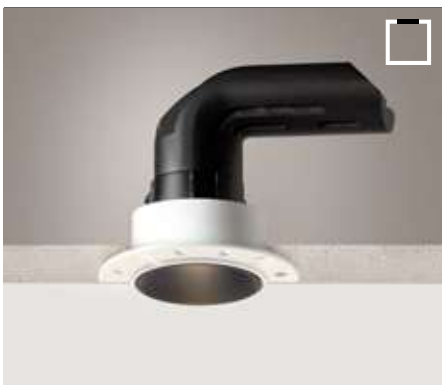

XR17401.040.1715

XR17402.040.1715

Potenza assorbita apparecchio / Luminaire power consumption 5,2W
Flusso luminoso apparecchio / Luminaire luminous flux 465lm
2700K Ra>90 24° 300mA DC

IP20

XR17401.040.2515

XR17402.040.2515

Potenza assorbita apparecchio / Luminaire power consumption 5,2W
Flusso luminoso apparecchio / Luminaire luminous flux 465lm
3000K Ra>90 24° 300mA DC

IP20

+ Electric options

(see details on page 206)

DRIVER

YDR.035.008.A01

YDR.035.008.A02

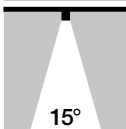
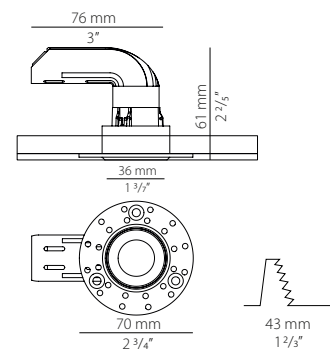

YLN17400.15

Lente per fascio stretto.
Spot optic.

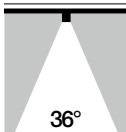

YLN17400.36

Lente per fascio medio.
Flood optic..

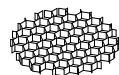

YGA17702.23

Griglia anti-abbagliamento in colore nero.
Anti-glare grid in black colour.

Fotometrie disponibili www.panzeri.it / Photometric data available at www.panzeri.it

CODICI COLORI DISPONIBILI / COLOUR CODES AVAILABLE

01 bianco
white

02 nero
black



NICK



Incasso rotondo in pressofusione di alluminio a dissipazione passiva con LED COB integrato in colore bianco. A richiesta riflettori con diverse aperture del fascio luminoso.

Round recessed spotlight in die-cast aluminium with passive thermal dissipation equipped with integrated LED COB finished in white colour. On request optics with different light beams.



XR25401.040.1715

Potenza assorbita apparecchio / Luminaire power consumption 3W
Flusso luminoso apparecchio / Luminaire luminous flux 153lm
2700K Ra>90 30° 700mA DC

XR25401.040.2515

Potenza assorbita apparecchio / Luminaire power consumption 3W
Flusso luminoso apparecchio / Luminaire luminous flux 170lm
3000K Ra>90 30° 700mA DC

IP43 IP20 IK07 850°

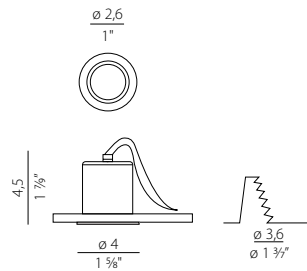

+ Electric options
(see details on page 206)

DRIVER
XM6-20 UNI ★
XM6-20 D/P MULTI ★

Protezione contro l'inversione di polarità
Reverse polarity protection

kg

0,10

0,10



XR22501.050.1715

Potenza assorbita apparecchio / Luminaire power consumption 6,5W
Flusso luminoso apparecchio / Luminaire luminous flux 434lm
2700K Ra>90 26° 700mA DC

XR22501.050.2515

Potenza assorbita apparecchio / Luminaire power consumption 6,5W
Flusso luminoso apparecchio / Luminaire luminous flux 455lm
3000K Ra>90 26° 700mA DC

IP65 IP20 IK08 850°

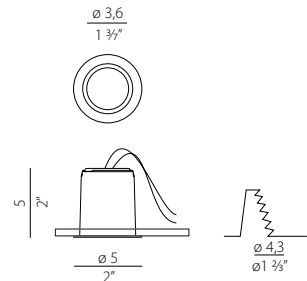

+ Electric options
(see details on page 206)

DRIVER
XM6-20 UNI ★
XM6-20 D/P MULTI ★
XM6-25 D/P MULTI ★

Protezione contro l'inversione di polarità
Reverse polarity protection

0,10

0,10

I driver non sono inclusi, vedi electric options.
Da acquistare separatamente.

Drivers not included, see electric options.
Please purchase separately.

★ Dimensione dell'alimentatore maggiore del foro d'incasso,
dunque installare l'alimentatore in apposito vano d'ispezione.

Power supply unit is larger than the recess hole, install the
power supply unit in a special inspection compartment.

kg

**XR26201.060.1715**

Potenza assorbita apparecchio / Luminaire power consumption 9W/12W
Flusso luminoso apparecchio / Luminaire luminous flux 609lm/830lm
2700K Ra>90 38° 250/350mA DC

XR26201.060.2515

Potenza assorbita apparecchio / Luminaire power consumption 9W/12W
Flusso luminoso apparecchio / Luminaire luminous flux 632lm/852lm
3000K Ra>90 38° 250/350mA DC

IP43 IP20 IK08 850°

+ Electric options

(see details on page 205)

DRIVER

XM6-15 UNI

XM6-20 UNI

XM6-20 D/P MULTI

XM6-25 D/P MULTI

0,30

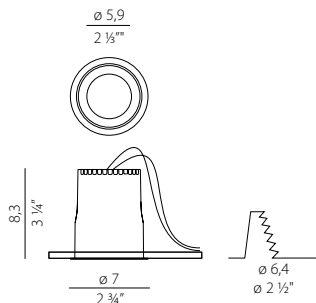

Protezione contro l'inversione di polarità
Reverse polarity protection

I driver non sono inclusi, vedi electric options. Da acquistare separatamente.
Drivers not included, see electric options.
Please purchase separately.

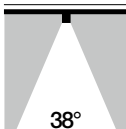
**STANDARD**

Ottica per fascio medio.
Flood optic.

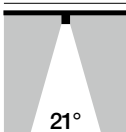
**XMR5**

Ottica per fascio stretto.
Spot optic.

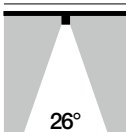
**XMR6**

Ottica per fascio medio.
Flood optic.

**XMR9**

Cilindro interno colore oro satinato.
Internal satin gold cylinder.

Fotometrie disponibili www.panzeri.it / Photometric data available at www.panzeri.it

CODICI COLORI DISPONIBILI / COLOUR CODES AVAILABLE

01 bianco
white



RALLY TRIM



Serie di incassi rettangolari ad emissione diretta con cornice in alluminio pressofuso per ambienti interni, disponibile in tre versioni con lunghezze differenti, in finitura bianca con ottiche nere. La sorgente luminosa arretrata è costituita da moduli LED accoppiati a lenti con fascio di 30°.

Series of rectangular direct-emitting die-casted aluminium downlights with frame for indoor application, available in three versions with different lengths, in white finish with black optics. The recessed light source is made of LED modules coupled with lenses with 30° beam angle.

kg



XR17801.007.1715

Potenza assorbita apparecchio / Luminaire power consumption 3,6W
Flusso luminoso apparecchio / Luminaire luminous flux 240lm
2700K Ra>90 30° 600mA DC

LED IP20

XR17801.007.2515

Potenza assorbita apparecchio / Luminaire power consumption 3,6W
Flusso luminoso apparecchio / Luminaire luminous flux 240lm
3000K Ra>90 30° 600mA DC

LED IP20

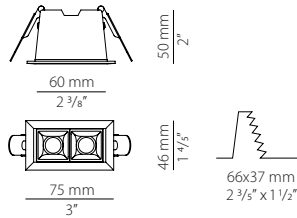

+ Electric options

(see details on page 206)

DRIVER

XM6-20 UNI

XM6-20 D/P MULTI

YDR.090.013.A02

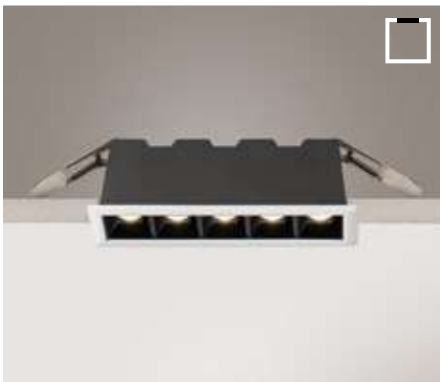

XR17801.014.1715

Potenza assorbita apparecchio / Luminaire power consumption 9W
Flusso luminoso apparecchio / Luminaire luminous flux 602lm
2700K Ra>90 30° 600mA DC

LED IP20

XR17801.014.2515

Potenza assorbita apparecchio / Luminaire power consumption 9W
Flusso luminoso apparecchio / Luminaire luminous flux 602lm
3000K Ra>90 30° 600mA DC

LED IP20

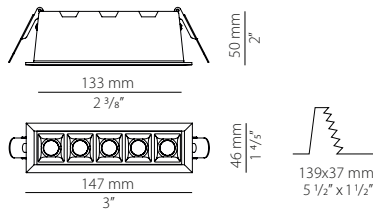

+ Electric options

(see details on page 206)

DRIVER

XM6-20 UNI

XM6-20 D/P MULTI

YDR.090.013.A02

**XR17801.028.1715**

Potenza assorbita apparecchio / Luminaire power consumption 18W
 Flusso luminoso apparecchio / Luminaire luminous flux 1204lm
 2700K Ra>90 30° 600mA DC

 **IP20** 

XR17801.028.2515

Potenza assorbita apparecchio / Luminaire power consumption 18W
 Flusso luminoso apparecchio / Luminaire luminous flux 1204lm
 3000K Ra>90 30° 600mA DC

 **IP20** 

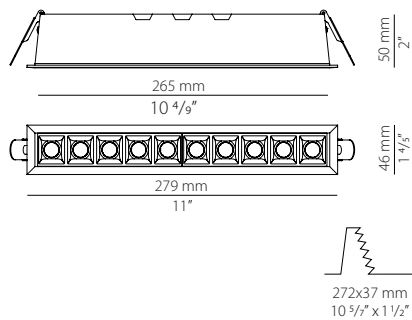
**+ Electric options**

(see details on page 206)

DRIVER

XM6-20 UNI

XM6-20 D/P MULTI

XM6-25 D/P MULTI

Fotometrie disponibili www.panzeri.it / Photometric data available at www.panzeri.it

CODICI COLORI DISPONIBILI / COLOUR CODES AVAILABLE

01 bianco
 white



SID



Piccolo faretto in alluminio ad emissione diretta per installazione ad incasso in ambienti interni. Diametro 20mm, sottilissima cornice a vista, sorgente luminosa arretrata. Disponibile in finitura bianco o nero.

Small direct-emitting aluminium spotlight for recessed indoor installations. Diameter 20 mm, recessed light source, very thin visible frame. Available in white or black finishes.

kg



XR17001.020.1715

XR17002.020.1715

Potenza assorbita apparecchio / Luminaire power consumption 2,1W
Flusso luminoso apparecchio / Luminaire luminous flux 180lm
2700K Ra>90 25° 700mA DC

IP20

XR17001.020.2515

XR17002.020.2515

Potenza assorbita apparecchio / Luminaire power consumption 2,1W
Flusso luminoso apparecchio / Luminaire luminous flux 180lm
3000K Ra>90 25° 700mA DC

IP20

+ Electric options

(see details on page 206)

DRIVER

YDA.070.012.A01 *

YDR.090.013.A02 *

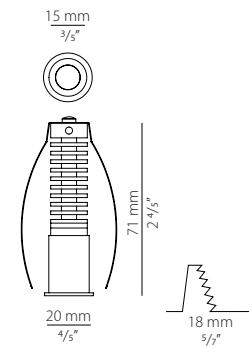

* Dimensione dell'alimentatore maggiore del foro d'incasso, dunque installare l'alimentatore in apposito vano d'ispezione.

Power supply unit is larger than the recess hole, install the power supply unit in a special inspection compartment.

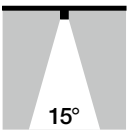

YLN17000.15

Lente per fascio stretto.
Spot optic

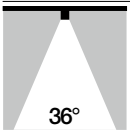

YLN17000.36

Lente per fascio medio.
Flood optic.

Fotometrie disponibili www.panzeri.it / Photometric data available at www.panzeri.it

CODICI COLORI DISPONIBILI / COLOUR CODES AVAILABLE

01 bianco
white

02 nero
black





TAYLOR



Incasso orientabile per interni, equipaggiato con LED COB di ultima generazione. È disponibile in versione a luce calda con accessori ottici intercambiabili, per un'illuminazione sia d'accento che diffusa. La parte mobile rimane nascosta nel controsoffitto. Il design professionale e la cornice sottile disponibile in diverse finiture rendono Taylor la soluzione ideale in progetti di retail, showroom e hospitality. L'ottica è arretrata per un basso livello di abbagliamento, così da garantire un migliore comfort visivo. La profondità di incasso è contenuta e consente una semplice e veloce installazione anche in spazi ristretti. Disponibile nelle finiture bianco, nero, bronzo, ottone satinato e titanio. Driver da acquistare separatamente.

Adjustable downlight for indoors, equipped with COB LED of latest generation. Available in white warm light with optical accessories interchangeable, for a diffused or accent illumination. The adjustable part is hidden within the false ceiling. The professional design and the minimal frame available in different finishes make Taylor the ideal solution for various projects, from retail stores or show-rooms to hospitality. The lens is recessed for low glaring, in order to provide an enhanced visual comfort. The minimal depth of recess allows a simple and quick installation also in false ceilings of limited spaces. Available in finish white, black, bronze, matte brass and titanium. Driver to order separately.

		kg
	X16801.008.2515 X16802.008.2515 X16817.008.2515 X16819.008.2515 X16830.008.2515 Potenza assorbita apparecchio / Luminaire power consumption 12W Flusso luminoso apparecchio / Luminaire luminous flux 824lm 3000K Ra>90 38° 360mA DC LED IP43 IP20 IK08 850°	+ Electric options (see details on page 206) DRIVER XM6-15 UNI XM6-20 D/P MULTI XM6-25 D/P MULTI I driver non sono inclusi, vedi electric options. Da acquistare separatamente. Drivers not included, see electric options. Please purchase separately.
		0,40

<p>38°</p>	STANDARD Ottica per fascio medio. Flood optic.
<p>21°</p>	XMR5 Ottica per fascio stretto. Spot optic.
<p>44°</p>	XMR8 Ottica per fascio largo. Wide flood optic.

Fotometrie disponibili www.panzeri.it / Photometric data available at www.panzeri.it

CODICI COLORI DISPONIBILI / COLOUR CODES AVAILABLE

- 01** bianco
white
- 02** nero
black
- 17** bronzo
bronze
- 19** ottone satinato
mat brass
- 30** titanio
titanium





JOE



Faretto da incasso in alluminio, bianco o nero con o senza sorgente GU10 LED Spot.

Aluminium recessed spotlight in white or black colour with or without GU10 LED Spot lamp.



XA2115

XA2115 BLA

XM3 lampholder with terminal block max 50W GU10 LED retrofit bulb 7,5W GU10 3000K 60° Ra80 608lm (no dimming) * IP20

ST.XA2115

ST.XA2115 BLA

XM3 lampholder with terminal block max 50W GU10 senza lampadina without bulb

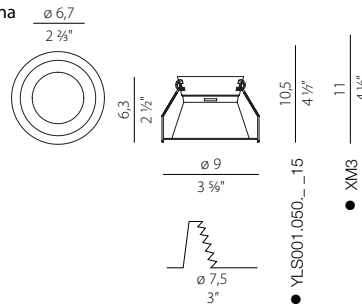

* Lampadina inclusa / Included bulb

kg

0,09



0,09

+ Electric options

(see details on page 205)

LAMP

YLS001.050...15 spot LED

DRIVER

XM6-15 UNI

XM6-20 UNI

XM6-20 D/P MULTI

XM6-25 D/P MULTI



XA2116

XA2116 BLA

XM3 lampholder with terminal block max 50W GU10 LED retrofit bulb 7,5W GU10 3000K 60° Ra80 608lm (no dimming) * IP20

ST.XA2116

ST.XA2116 BLA

XM3 lampholder with terminal block max 50W GU10 senza lampadina without bulb

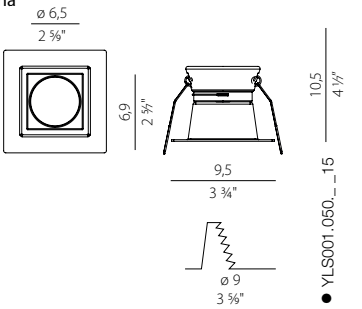

* Lampadina inclusa / Included bulb

0,12



0,12

+ Electric options

(see details on page 205)

LAMP

YLS001.050...15 spot LED

DRIVER

XM6-15 UNI

XM6-20 UNI

XM6-20 D/P MULTI

XM6-25 D/P MULTI

● Minima altezza di ingombro dell'apparecchio (le quote minime del vano di incasso sono riportate sul foglio di istruzioni)

Minimum height of the appliance (see the minimum values for housing compartment in the instruction sheets)

Fotometrie disponibili www.panzeri.it / Photometric data available at www.panzeri.it

CODICI COLORI DISPONIBILI / COLOUR CODES AVAILABLE

bianco white **BLA** nero black

ELECTRIC OPTIONS

- 205 **ELECTRIC OPTIONS**
- 210 **TECHNICAL INFORMATION**
- 213 **FONDAMENTI DI ILLUMINOTECNICA / LIGHTING BASICS**



ELECTRIC OPTIONS

COMPONENTI ELETTRICI / ELECTRICAL COMPONENTS

XM3

LAMPHOLDER + TERMINAL BLOCK

MAX 9W GU10 

IP20  

LED CORRENTE COSTANTE / LED CONSTANT CURRENT

YLS001.050.1715 (2700K)

YLS001.050.2515 (3000K)

YLS001.050.2915 (4000K)

LED 8,5W 250mA 35V 35° Ra>90

Flusso luminoso apparecchio

Luminaire luminous flux:

2700K - 806lm

3000K - 854lm

4000K - 1053lm



TECHNICAL INFORMATION	WIRING DIAGRAM 4
PAG. 210	PAG. 211

See matrix page 209



YLS005.050.1715 (2700K)

YLS005.050.2515 (3000K)

LED 12W 350mA 34,3V 36° Ra>90

Flusso luminoso apparecchio

Luminaire luminous flux:

2700K - 1370lm

3000K - 1500lm



TECHNICAL INFORMATION	WIRING DIAGRAM 4
PAG. 210	PAG. 211

See matrix page 209



LED TENSIONE COSTANTE / LED CONSTANT VOLTAGE

XM006.050.0410

Modulo / module 500 mm 64LED

8,6W 3000K Ra90 24V 1140lm

 62,5mm **2280 lm/m**



TECHNICAL INFORMATION	WIRING DIAGRAM 1
PAG. 210	PAG. 211

See Matrix page 209

500 x 14 mm

19 3/4" x 5/8"



XM006.012.0410

Modulo / module 125 mm 16LED

2,15W 3000K Ra90 24V 285lm

 62,5mm **2280 lm/m**



TECHNICAL INFORMATION	WIRING DIAGRAM 1
PAG. 210	PAG. 211

See Matrix page 209

125 x 14 mm

5" x 5/8"



YLR007.022.0510 (2700K)

YLR007.022.0410 (3000K)

YLR007.022.0610 (4000K)

STRIP ROLL 5 m 2700/3000/4000K Ra90 24V

 4,2 mm

5 x 240 LED/m - 5 x 22 W/m

5 x **2795 lm/m** (2700K)

5 x **2950 lm/m** (3000K)

5 x **3035 lm/m** (4000K)



TECHNICAL INFORMATION	WIRING DIAGRAM 2
PAG. 210	PAG. 211

See Matrix page 209

5000 x 10 mm

197" x 3/8"



YLR006.017.0510 (2700K)

YLR006.017.0410 (3000K)

YLR006.017.0610 (4000K)

STRIP ROLL 5 m 2700/3000/4000K Ra90 24V

 5 mm

5 x 200 LED/m - 5 x 16,8 W/m

5 x **2165 lm/m** (2700K)

5 x **2285 lm/m** (3000K)

5 x **2335 lm/m** (4000K)



TECHNICAL INFORMATION	WIRING DIAGRAM 2
PAG. 210	PAG. 211

See Matrix page 209

5000 x 8 mm

197" x 1/2"



YLR005.010.0510 (2700K)

YLR005.010.0410 (3000K)

YLR005.010.0610 (4000K)

STRIP ROLL 5 m 2700/3000/4000K Ra90 24V

 5 mm

5 x 200 LED/m - 5 x 9,6 W/m

5 x **1250 lm/m** (2700K)

5 x **1335 lm/m** (3000K)

5 x **1390 lm/m** (4000K)



TECHNICAL INFORMATION	WIRING DIAGRAM 2
PAG. 210	PAG. 211

See Matrix page 209

5000 x 8 mm

197" x 1/2"



YLR008.010.0510 (2700K)

YLR008.010.0410 (3000K)

STRIP ROLL IP67 5 m 2700/3000K Ra90 24V

 5 mm

5 x 200 LED/m - 5 x 9,6 W/m

5 x **1100 lm/m** (2700K)

5 x **1175 lm/m** (3000K)



TECHNICAL INFORMATION	WIRING DIAGRAM 2
PAG. 210	PAG. 211

See Matrix page 209

5000 x 10 mm

197" x 3/8"



ELECTRIC OPTIONS

SORGENTI LED / LED LAMP 220-240V

YLL001.050.2201 7,5W GU10 Ø 50 mm 3000K Ra80 680lm 60° 220-240V NOT DIMMABLE



YLL002.050.2201 7,5W GU10 Ø 50 mm 3000K Ra80 680lm 60° 220-240V NOT DIMMABLE



XM5/GU10-35 4W GU10 Ø 35 mm 3000K Ra80 340lm 220-240V NOT DIMMABLE



XM5/G9LED 4W G9 3000K Ra80 330lm 110-240V NOT DIMMABLE



LED DRIVER CORRENTE COSTANTE / LED DRIVER CONSTANT CURRENT

XM6-15 UNI

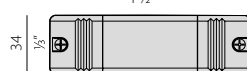
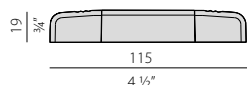

V in 100-240V AC
V out 2-41,5V DC
I out 60-360mA
W 2,5-15
λ 0,80
SELV
See Matrix page 209

XM6-20 UNI

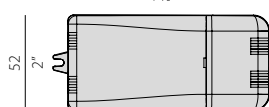
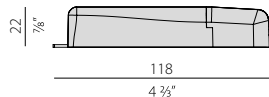

V in 220-240V AC
V out 2-54V DC
I out 250-700mA
W 4-20
λ 0,95
SELV
See Matrix page 209

YDA.070.012.A01

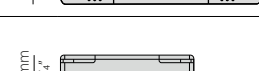
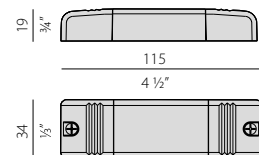

V in 220-240V AC
V out 2-16V DC
I out 700mA
W 12
λ 0,85
SELV
See Matrix page 209

YDR.035.008.A01

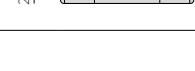
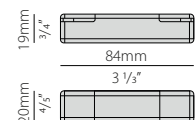

V in 220-240V AC
V out 8-22,5V DC
I out 200-350mA
W 4,5-7,9
λ 0,50
SELV
See Matrix page 209

LED DRIVER TENSIONE COSTANTE 48V / LED DRIVER CONSTANT VOLTAGE 48V

YDV.048.075.A01

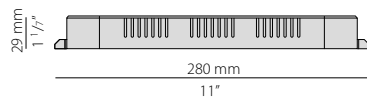

V in 220-240V AC
V out 48V DC
I out 1,55A DC
W 75
λ ≥ 0,96
SELV

YDV.048.150.A01

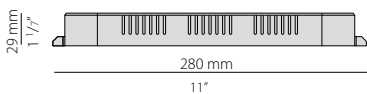

V in 220-240V AC
V out 48V DC
I out 3,125A DC
W 150
λ ≥ 0,96
SELV

YDV.048.150.A02

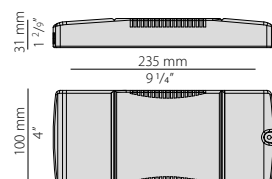

V in 220-240V AC
V out 48V DC
I out 3,125A DC
W 150
λ 0,99
SELV PUSH DIM DALI

ELECTRIC OPTIONS

LED DRIVER CORRENTE COSTANTE DIMMERABILE / LED DRIVER DIMMABLE CONSTANT CURRENT

YDR.035.008.A02		<p>V in 220-240V AC V out 5-42V DC I out 120-350mA W 5-8,4 λ 0,95</p>	
YDR.035.012.A02		<p>V in 220-240V AC V out 9-42V DC I out 120-350mA W 5-14,7 λ 0,95</p>	
YDR.050.012.A02		<p>V in 220-240V AC V out 6-40V DC I out 200-500mA W 8-10 λ ≥ 0,90</p>	
YDR.090.013.A02		<p>V in 220-240V AC V out 24V DC I out 600-900mA W 9,6-9,9 λ ≥ 0,90</p>	
XM6-20 D/P MULTI		<p>V in 220-240V AC V out 3-46V DC I out 200-900mA W 9,2-28 λ ≥ 0,95</p>	
XM6-25 D/P MULTI		<p>V in 220-240V AC V out 3-55V DC I out 200-900mA W 11-25,6 λ ≥ 0,92</p>	

LED DRIVER TENSIONE COSTANTE 24V DIMM. TAGLIO DI FASE / LED DRIVER CONSTANT VOLTAGE 24V PHASE CUT DIM

YDV.024 .050.A04		<p>V in 220-240V AC V out 24V DC I out 2,08A DC W 50 λ 0,9</p>	<p> </p>
YDV.024.100.A04		<p>V in 220-240V AC V out 24V DC I out 2,08A DC W 100 λ 0,9</p>	<p> </p>
YDV.024 .150.A04		<p>V in 220-240V AC V out 24V DC I out 2,08A DC W 150 λ 0,9</p>	<p> </p>

ELECTRIC OPTIONS

LED DRIVER TENSIONE COSTANTE 24V / LED DRIVER CONSTANT VOLTAGE 24V

XM6-20 UNI

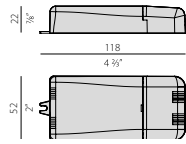

V in 220-240V AC
 V out 24V DC
 I out 700mA DC
 W 16
 λ 0,97
 SELV
 See Matrix page 209

YDV.024.030.A01

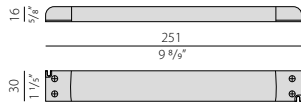

V in 220-240V AC
 V out 24V DC
 I out 1,25A DC
 W 30
 λ ≥ 0,9
 SELV
 See Matrix page 209

YDV.024.075.A01

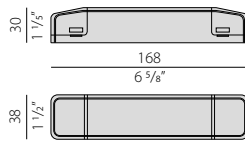

V in 220-240V AC
 V out 24V DC
 I out 3,13A DC
 W 75
 λ 0,9
 SELV
 See Matrix page 209

YDV.024.120.A01

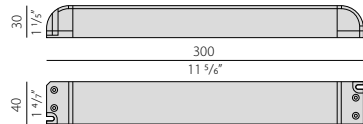

V in 220-240V AC
 V out 24V DC
 I out 5A DC
 W 120
 λ 0,95
 SELV
 See Matrix page 209

YDV.024.180.A01

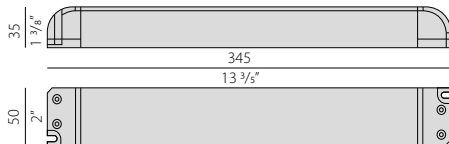

V in 220-240V AC
 V out 24V DC
 I out 7,5A DC
 W 180
 λ 0,95
 SELV
 See Matrix page 209

YDV.024.018.A02

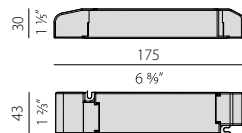

V in 220-240V AC
 V out 24V DC
 I out 0,75A DC
 W 18
 λ 0,97
 SELV PUSH DIM DALI
 See Matrix page 209

YDV.024.035.A02

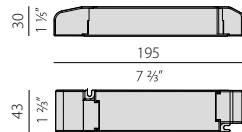

V in 220-240V AC
 V out 24V DC
 I out 1,458A DC
 W 35
 λ 0,97
 SELV PUSH DIM DALI
 See Matrix page 209

YDV.024.060.A02

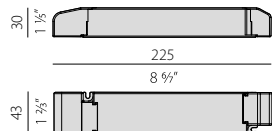

V in 220-240V AC
 V out 24V DC
 I out 2,50A DC
 W 60
 λ 0,99
 SELV PUSH DIM DALI
 See Matrix page 209

YDV.024.100.A02

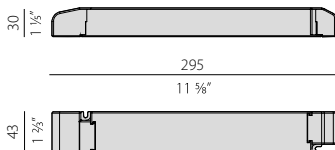

V in 220-240V AC
 V out 24V DC
 I out 4,17A DC
 W 100
 λ 0,99
 SELV PUSH DIM DALI
 See Matrix page 209

YDV.024.200.A02

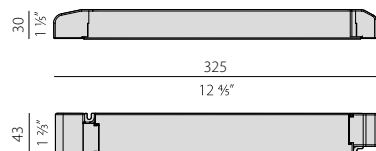

V in 220-240V AC
 V out 24V DC
 I out 8,34A DC
 W 200
 λ 0,99
 SELV PUSH DIM DALI
 See Matrix page 209

ELECTRIC OPTIONS

SISTEMI DI CONTROLLO LED / LED CONTROL SYSTEM

Dispositivi per la dimmerazione di moduli LED a 12, 24 e 48V DC. Utilizzabili con alimentatore standard (non dimmerabile). E' possibile applicarli anche in impianti esistenti senza sostituire gli alimentatori già in uso.

Dimming devices for LED modules (12, 24, 48 V DC). Can be used with standard drivers (not dimmable). It's also possible to use the device in existing lighting systems without replacing the already installed drivers.

YCO.C048.A02

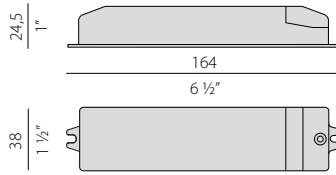

DISPOSITIVO DIMMERABILE / DIMMING DEVICE

Modalità di dimmerazione / Dimming mode:

0-10V, 1-10V, PUSH DIM, DALI

Master, slave

V in 12-48V DC

I out 12A DC

W 12V: 144W - 24V: 288W - 48V: 576W

SELV 0...10V 1...10V PUSH DIM DALI

TECHNICAL INFORMATION	WIRING DIAGRAM 6
PAG. 210	PAG. 212

See Matrix page 209

YCO.D048.A02

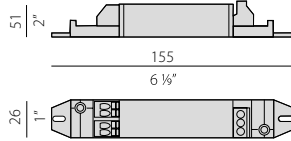

DISPOSITIVO DIMMERABILE / DIMMING DEVICE

Modalità di dimmerazione / Dimming mode:

1-10V, PUSH DIM, DALI

V in 12-48V DC

I out 6A DC

W 12V: 72W - 24V: 144W - 48V: 288W

SELV 1...10V PUSH DIM DALI

TECHNICAL INFORMATION	WIRING DIAGRAM 7
PAG. 210	PAG. 212

See Matrix page 209

MATRICE LED/DRIVER - LED/DRIVER MATRIX

MODELLO / MODEL	YLS001	YLS005	XM006	YLR005	YLR006	YLR007	YLR008	YLR101	YLR102
Constant current									
XM6-15 UNI	1	1							
XM6-20 UNI	1	1	• (24V setting)	• (24V setting)	• (24V setting)	• (24V setting)	• (24V setting)	• (24V setting)	• (24V setting)
YDA.070.012.A01									
YDR.035.008.A01									
YDR.035.008.A02									
YDR.035.012.A02	1	1							
YDR.050.012.A02	1	1							
YDR.090.013.A02									
XM6-20 D/P MULTI	1	1							
XM6-25 D/P MULTI	1	1							

Constant voltage									
YDV.024.030.A01			•	•	•	•	•	•	•
YDV.024.075.A01			•	•	•	•	•	•	•
YDV.024.120.A01			•	•	•	•	•	•	•
YDV.024.180.A01			•	•	•	•	•	•	•
YDV.024.018.A02			•	•	•	•	•	•	•
YDV.024.035.A02			•	•	•	•	•	•	•
YDV.024.060.A02			•	•	•	•	•	•	•
YDV.024.100.A02			•	•	•	•	•	•	•
YDV.024.200.A02			•	•	•	•	•	•	•
YDV.024.050.A04			•	•	•	•	•	•	•
YDV.024.100.A04			•	•	•	•	•	•	•
YDV.024.150.A04			•	•	•	•	•	•	•

Led control systems									
YCO.C048.A02			•	•	•	•	•	•	•
YCO.D048.A02			•	•	•	•	•	•	•

TECHNICAL INFORMATION

APPARECCHI CON LED A TENSIONE COSTANTE 24V DC

Le nostre strip LED sono state studiate per essere installate all'interno dei nostri prodotti: se impiegate in altre situazioni, è necessario dissipare adeguatamente il calore.

Il collegamento tra i vari apparecchi/LED deve essere effettuato in parallelo.

Nella scelta dell'alimentatore, mantenere sempre un margine aggiuntivo del 10% sulla potenza impiegata.

E' necessario considerare la distanza tra alimentatori e apparecchi/LED per limitare possibili cadute di tensione.

La tabella 1 (sotto) indica la distanza massima tra alimentatore e gli apparecchi/LED in funzione della sezione del cavo e della potenza, con alimentazione a 24V DC.

FIXTURES USING LEDS WITH A CONSTANT VOLTAGE OF 24V DC

Our LED strips are designed to be installed in our products; if installed elsewhere please consider thermal management by using proper heatsinks.

The connection between the various fixtures / LEDs must be carried out in parallel. Always consider an increase of 10% on the power used defying power supply.

The distance between power supplies and fixtures / LED must be considered to limit possible voltage drop.

Table 1 (below) indicates the maximum distance between the power supply and the luminaires / LEDs according to cable section and power, with 24V DC power supply.

TABELLA 1

W	1 mm ²	1,5 mm ²	2,5 mm ²
10	56 m	85 m	141 m
20	28 m	42 m	71 m
30	19 m	28 m	47 m
40	14 m	21 m	35 m
50	11 m	17 m	28 m
60	9 m	14 m	24 m
70	8 m	12 m	20 m
80	7 m	11 m	18 m
90	6 m	9 m	16 m
100	6 m	8 m	14 m
110	5 m	8 m	13 m
120	5 m	7 m	12 m
130	4 m	7 m	11 m
140	4 m	6 m	10 m
150	4 m	6 m	9 m

WIRING DIAGRAM NR. 1

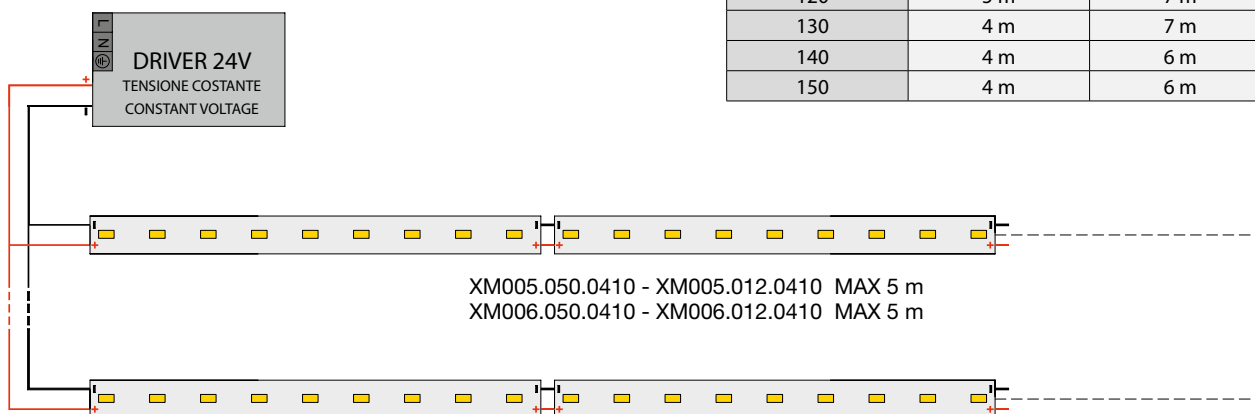

WIRING DIAGRAM NR. 2

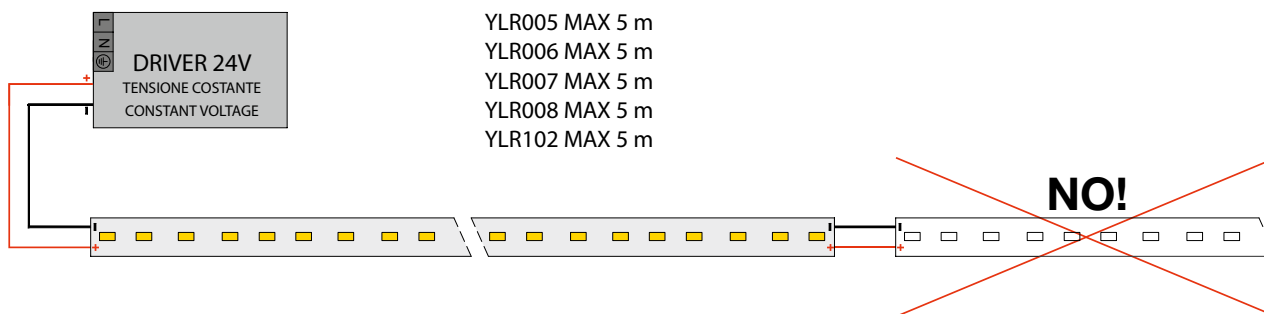

TECHNICAL INFORMATION

WIRING DIAGRAM NR. 3

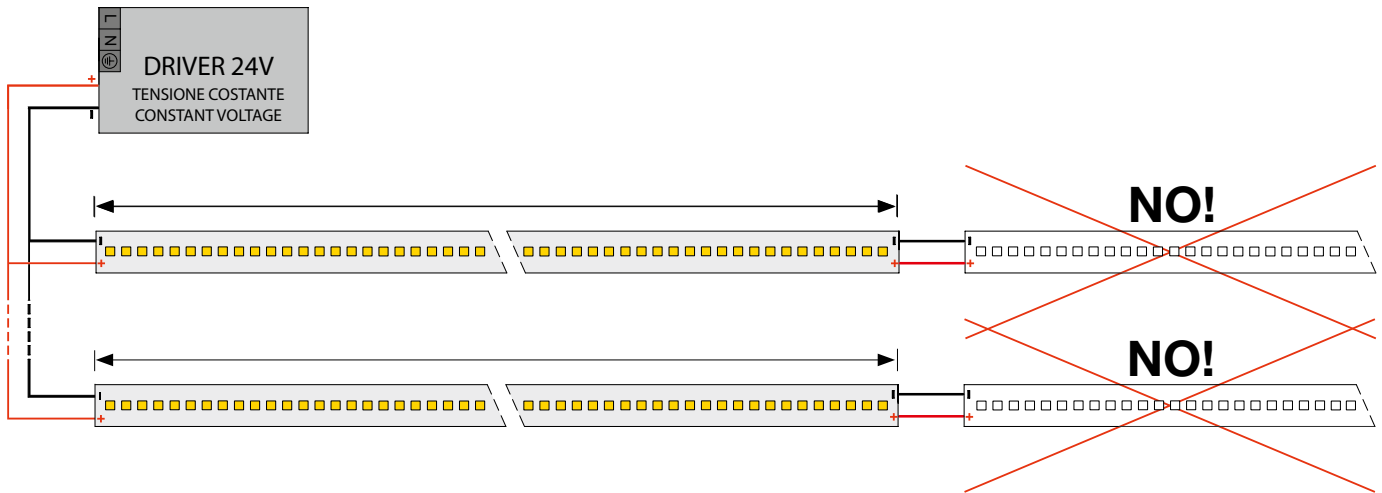

APPARECCHI CON LED A CORRENTE COSTANTE

Il collegamento tra i vari apparecchi/led deve essere effettuato in serie. Il numero di LED per alimentatore dipende dalla potenza e dalla tensione che l'alimentatore rende disponibile. Nonostante l'utilizzo di correnti molto basse è opportuno considerare la distanza tra alimentatori e apparecchi/LED. Segue la tabella 2 che indica la lunghezza/sezione del cavo con alimentazione a corrente costante. Viene indicata la distanza massima tra alimentatore e apparecchi/LED.

FIXTURES USING LEDS WITH A CONSTANT CURRENT

The connection between the various fixtures / LEDs must be carried out in series. The number of LEDs per power supply unit depends on the available power and voltage of the unit. Notwithstanding the use of very low currents, it is advisable to take into consideration the distance between ballasts and fixtures / LEDs. Table 2 (below) indicates the length / section of the cable using a constant current supply. It shows the maximum distance between the power supply and the fixture/LED.

TABELLA 2			
Sezione	1 mm ²	1,5 mm ²	2,5 mm ²
Lunghezza	20 m	30 m	50 m

WIRING DIAGRAM NR. 4

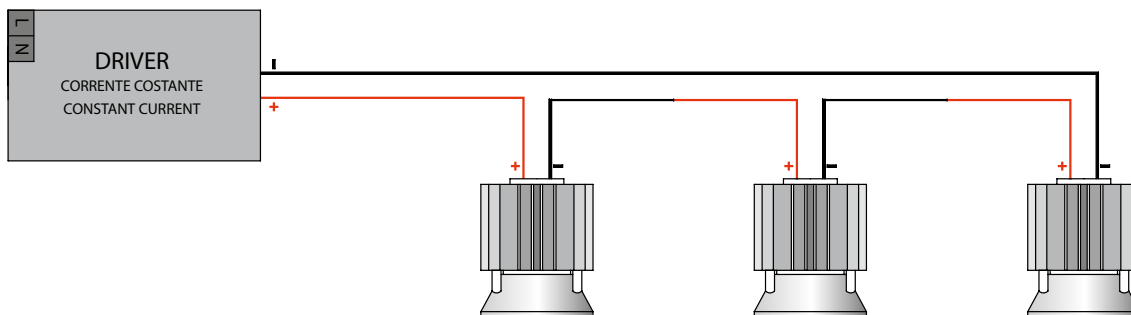

WIRING DIAGRAM NR. 5

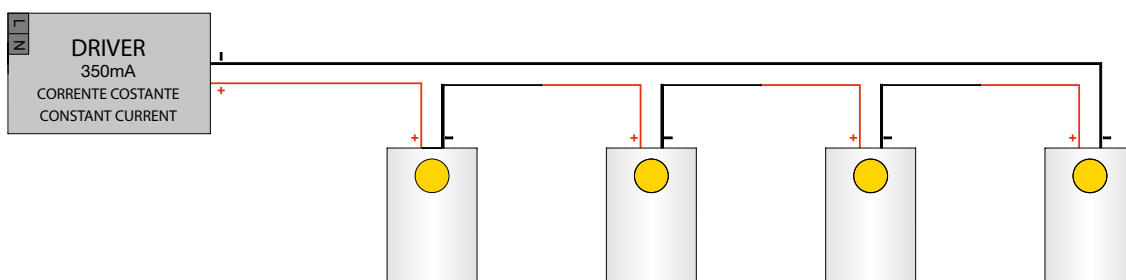

TECHNICAL INFORMATION

WIRING DIAGRAM NR. 6

YCO.C048.A02

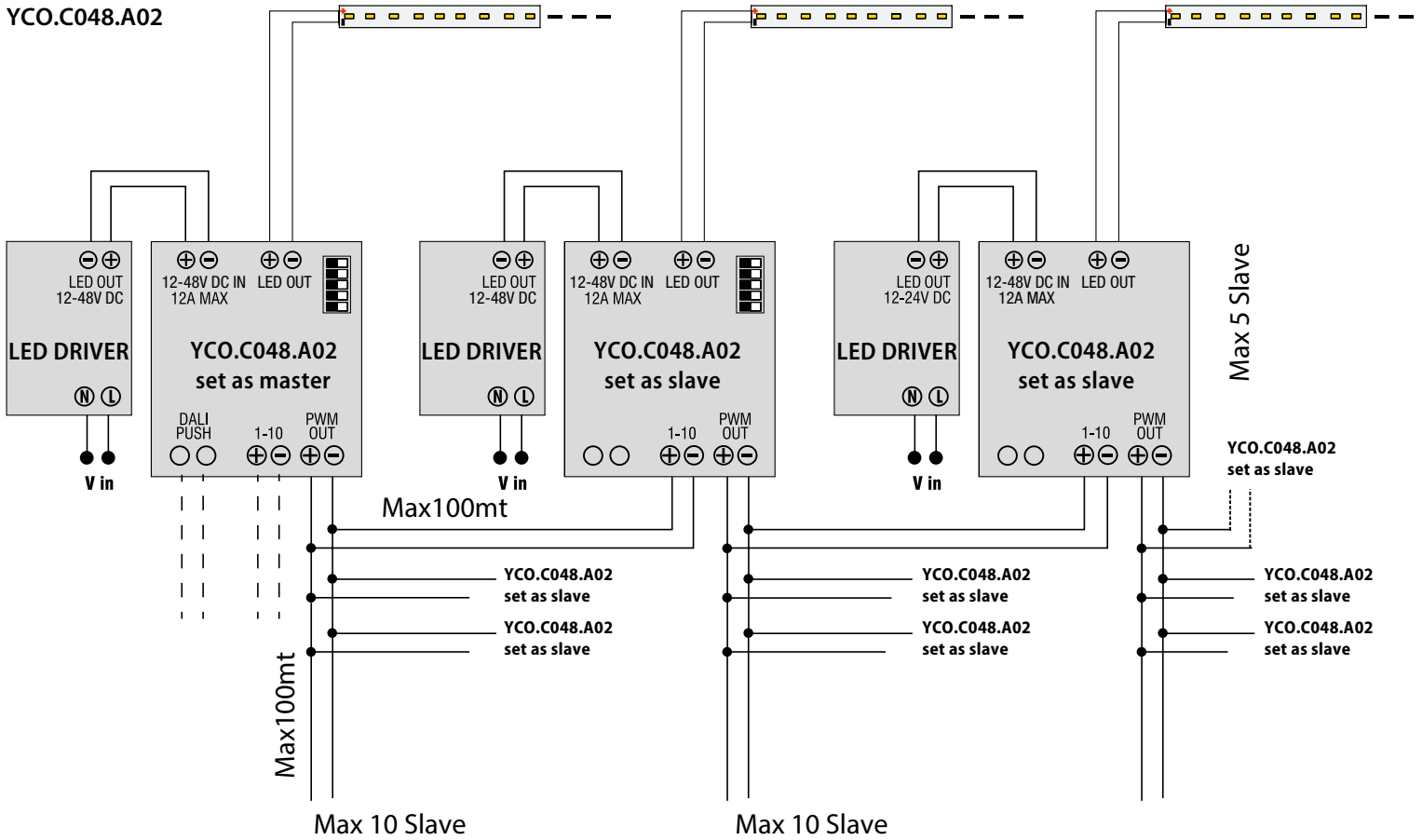

WIRING DIAGRAM NR. 7

YCO.D048.A02

Wiring diagram DALI

Wiring diagram Push

Wiring diagram Trimmer 1/10V

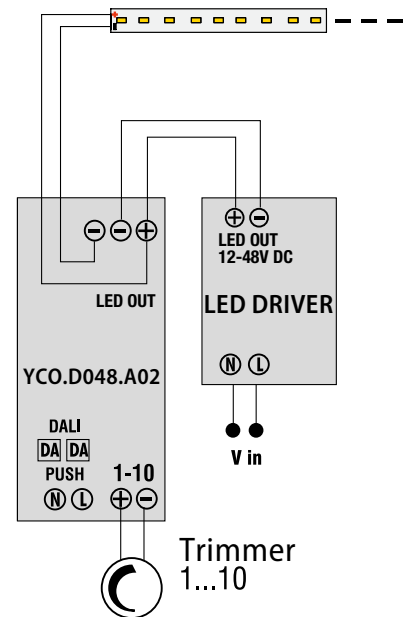
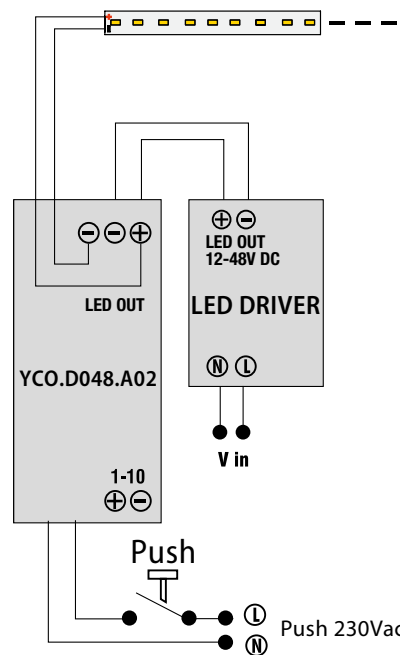
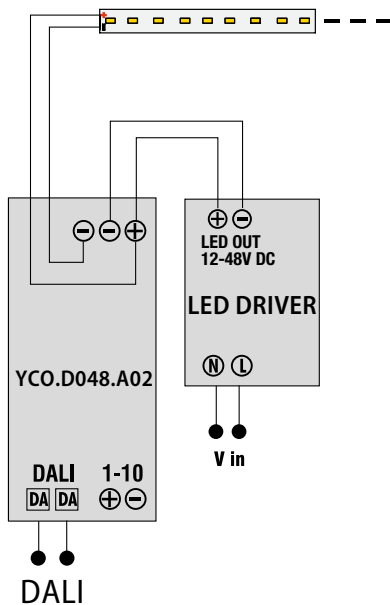

FLUSSO LUMINOSO Φ

Unità di misura: lumen (lm)

Per flusso luminoso si intende l'intera potenza irradiata dalla sorgente luce che viene valutata con la sensibilità spettrale dell'occhio. Il flusso luminoso è una grandezza molto utile per confrontare le lampade tradizionali con i LED.

LUMINOUS FLUX Φ

Unit: lumen (lm)

Luminous flux means the total power radiated by a light source, which is evaluated considering the spectral sensitivity of the eye. The luminous flux is a measurement very useful when comparing traditional lamps with LEDs.

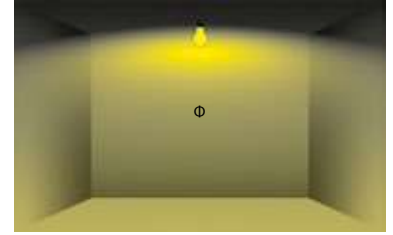

INTENSITÀ LUMINOSA I

Unità di misura: candela (cd)

Una sorgente luminosa irradia il suo flusso luminoso generalmente in diverse direzioni con diversa intensità. L'intensità della luce irradiata in una determinata direzione viene definita intensità luminosa.

LUMINOUS INTENSITY I

Unit: candela (cd)

A light source emits its luminous flux usually in different directions and at different intensities. The intensity of light radiated in a given direction is defined as light intensity.

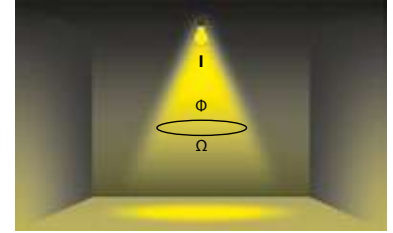

ILLUMINAMENTO E

Unità di misura: lux (lx)

L'illuminamento è dato dal rapporto tra il flusso luminoso irradiato e la superficie illuminata.

L'illuminamento prodotto da un flusso luminoso di 1 lm che cade in modo uniforme su una superficie di 1 m² è pari a 1 lx.

ILLUMINANCE E

Unit: lux (lx)

Illuminance is the ratio of the luminous flux and the illuminated surface.

The illumination produced by a luminous flux of 1 lm that falls evenly on a surface of 1 square meter is equal to 1 lx.

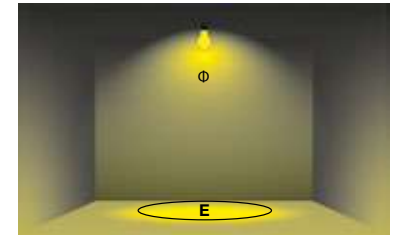

LUMINANZA L

Unità di misura: candela per metro quadrato [cd/m²]

La luminanza L di una sorgente di luce o di una superficie illuminata è determinante per la sensazione di luce percepita.

LUMINANCE L

Unit: candela per square meter [cd/m²]

The luminance L of a light source or an illuminated surface indicates how much luminous power will be detected by an eye looking at the surface from a particular angle of view.

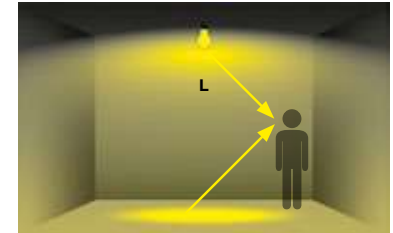

L'EFFICIENZA LUMINOSA

Unità di misura: lumen per watt (lm/W)

L'efficienza luminosa indica il rendimento di una lampada.

Viene espressa dal rapporto fra il flusso luminoso prodotto in lumen e la potenza applicata in watt.

LUMINOUS EFFICACY

Unit: lumens per watt (lm/W)

Luminous efficacy indicates the efficiency of a lamp. It is the ratio between the luminous flux in lumens produced and the applied power in watts.

TEMPERATURA DI COLORE

Unità di misura: kelvin (K)

Temperatura di colore indica la tonalità della luce. Più è alto il valore e più fredda è la tonalità della luce

3000K - tonalità calda

4000K - tonalità neutra

5500K - tonalità diurna

COLOUR TEMPERATURE

Unit: kelvin (K)

Colour temperature indicates a light's tonality: the higher the value, the colder the tone of the light

3000K - warm tone

4000K - neutral tone

5500K - daylight tone

INDICE DI RESA CROMATICA

Ra oppure in inglese Color Rendering Index (CRI)

Si indica come resa cromatica la fedeltà nella riproduzione dei colori sotto una certa illuminazione.

L'indice massimo di 100 rappresenta la resa cromatica ideale.

COLOR RENDERING INDEX

Ra or Color Rendering Index (CRI)

Ra is a quantitative measure of the ability of a light source to reproduce the colors of various objects faithfully in comparison with an ideal or natural light source.

The Ra maximum value 100 equals ideal color rendering.

MARCHI / MARKS



Prodotto conforme alle norme di sicurezza e alle direttive europee vigenti. **Tutti i prodotti Panzeri sono conformi alle prescrizioni del marchio CE.**
Product complying with safety rules and EU directives. **All Panzeri's products are compliant with CE mark requirements.**



Apparecchio in classe II
Apparecchio nel quale la protezione contro la scossa elettrica non si basa unicamente sull'isolamento fondamentale, ma anche sulle misure supplementari di sicurezza costituite dal doppio isolamento o dall'isolamento rinforzato. Queste misure non comportano dispositivi per la messa a terra e non dipendono dalle condizioni di installazione.
Class II Fixture
A fixture for which protection against an electric shock does not rely only on basic insulation but also offers further safety measures, such as double insulation or reinforced insulation.
These measures do not require grounding devices and are not dependent upon installation conditions.



Apparecchio in classe III
Apparecchio in cui la protezione contro la scossa elettrica si basa sull'alimentazione a bassissima tensione di sicurezza e in cui non si generano tensioni superiori alla stessa.
Nota: un apparecchio in classe III non deve essere provvisto di messa a terra.
Class III Fixture
A fixture in which protection against an electric shock is guaranteed by the extremely low and safe voltage level of the power supply, which does not generate higher voltage levels. NB: a Class III fixture does not require grounding protection.

IP..

Grado di protezione
Il grado di protezione degli apparecchi di illuminazione viene indicato con la sigla "IP" seguita da due cifre caratteristiche.
- la prima indica la protezione contro la penetrazione dei corpi solidi e della polvere
- la seconda indica la protezione contro la penetrazione dei liquidi
Protection Index
The protection rating of the lighting appliances is shown by the letters "IP" followed by two characteristic digits
- the first of these two digits indicates the degree of protection that the appliances offer against the entry of solid foreign objects
- the second one indicates the protection against the entry of water

IK

Grado di protezione degli involucri per apparecchiature elettriche contro impatti meccanici esterni (codice IK)
Degree of protection provided by enclosures for electrical equipment against external mechanical impacts (IK code)



Lampadina protetta contro esplosioni
Lamp protected against explosion

RoHS

RoHS - DIRETTIVA 2002/95/CE (Restriction of the use of certain Hazardous Substances in electrical and electronic equipment) Direttiva europea che limiti l'utilizzo di alcune sostanze pericolose (piombo, cadmio, mercurio, cromo esavalente, bifenile polibromurati, Eteri difendi polibromurati. A partire da 1 luglio 2006 tali sostanze non possono essere più impiegate nei prodotti elettrici ed elettronici, salvo deroghe su alcune applicazioni.
RoHS - DIRECTIVE 2002/95/CE (Restriction of the use of certain Hazardous Substances in electrical and electronic equipment). The European Directive restricts the use of some dangerous substances: lead, mercury, cadmium, hexavalent chromium, polybrominated biphenyls (PBB) or polybrominated diphenyl ethers (PBDE). From 1st July 2006 such substances shall not be used anymore in electrical and electronic equipment apart from exceptions on specific applications.



Marchio unico di certificazione EAC (EurAsian Certification) che sostituisce i marchi nazionali GOST (R per la Russia, B per Bielorussia e K per Kazakistan)
Unique brand of EAC certification (Eurasian Certification) which replaces the national GOST brands (R for Russia, B for Belarus and K for Kazakhstan).

SELV

Bassissima tensione di sicurezza
Safety Extra Low Voltage

1...10V

Dimmer analogico con segnale di tensione continua 1...10V
Analogic dimmer with a direct voltage signal



Dimmer a taglio di fase ascendente/discendente (TRIAC)
Phase cutting dimmer leading edge, trailing edge (TRIAC)

DALI

Dimmer digitale con interfaccia DALI
Digital dimmer with DALI interface

**DALI/PUSH
DIM**

Dimmer con funzionalità DALI o pulsante normalmente aperto NA
Dimmer for DALI protocol or push button application

PUSH DIM

Dimmer con pulsante normalmente aperto NA
Dimmer with push button NO

STEP DIM

Step Dim: accensione massima + 3 livelli di dimmerazione + spegnimento tramite sensore touch.
Step Dim: max on + 3 dimming levels + off through touch sensor.



Alimentatore idoneo al montaggio indipendente
Independent driver can be mounted separately outside a luminaire

**1H/12H
EMERGENCY**

Emergenza integrata. Autonomia 1h / Tempo di ricarica 12h
Integrated emergency. Duration 1h/Recharging time 12h

850°

Prova del filo incandescente a 850°C.
Glow wire test at 850° degree.

PANZERI CARLO SRL ADERISCE AL CONSORZIO ECOLIGHT – MILANO ITALY

WEEE - DIRETTIVA 2002/96/CE, 2003/108/CE (WASTE ELECTRICAL AND ELECTRONIC EQUIPMENT) RIFIUTI DI APPARECCHI ELETTRICI ED ELETTRONICI.

La direttiva valida su tutto il territorio dell'Unione Europea definisce una serie di misure allo scopo di prevenire la produzione di rifiuti di apparecchiature elettriche ed elettroniche; di promuovere il riuso, il riciclo ed altre forme di recupero di tali tipologie di rifiuti; di limitare i rischi di impatto sull'ambiente derivanti dal trattamento e dallo smaltimento dei rifiuti in questione; di armonizzare le misure nazionali di gestione dei rifiuti elettrici ed elettronici.

Gli apparecchi di illuminazione marcati con l'apposito simbolo del cassonetto barrato  sono soggetti a raccolta differenziata separata dal resto dei rifiuti urbani.

Per la restituzione di un dispositivo dimesso, occorre servirsi dei sistemi di restituzione e di raccolta messi a disposizione nei singoli paesi di utilizzo.

PANZERI CARLO SRL JOINS CONSORZIO ECOLIGHT – MILANO ITALY

WEEE - DIRECTIVE 2002/96/CE, 2003/108/CE (WASTE ELECTRICAL AND ELECTRONIC EQUIPMENT).

The European Directive is applicable throughout the European Union and determines the measures in order to prevent the production of waste electrical and electronic equipment; to promote the re-use, the recycle and other forms of reutilization of these kind of waste; to restrict the risks of impact to the environment coming from treatment and disposal of these equipments; to harmonize national measures of managing waste electrical and electronic equipment.

Equipment marked with proper symbol of crossed container  may not be disposed of with household rubbish.

To return the used device, the return and collection systems available in every single Country must be used.

Panzeri utilizza energia elettrica prodotta da fonti rinnovabili / Panzeri employs electricity from renewable sources



CONDIZIONI DI VENDITA

Alle vendite si applicano le condizioni generali di vendita e la garanzia pubblicati sul nostro sito internet www.panzeri.it alla data di accettazione dell'ordine da parte di Panzeri Carlo SRL

SALES CONDITIONS

Sales are regulated by the general export sales conditions and warranty published on our website www.panzeri.it at the time of confirmation of the order by Panzeri Carlo SRL



ADERENTE AD ASSOLOMBARDA
CONFINDUSTRIA MILANO MONZA E BRIANZA



Riconoscimento attribuito per oltre 50 anni di attività
Recognition given for over 50 years of continuous activity



ADIMEMBER
ADI ASSOCIAZIONE PER IL DISEGNO INDUSTRIALE



Pur mantenendo inalterate le proprie caratteristiche di base, i nostri articoli possono risultare parzialmente modificati rispetto a come sono raffigurati nel presente catalogo. Ciò è dovuto all'evoluzione a cui sottoponiamo i prodotti, con lo scopo di un miglioramento continuo. Anche i colori presentati nel catalogo sono da considerarsi puramente indicativi.

While maintaining the basic characteristics of the product, the Company reserves the right to make modifications at any time with the sole aim of improvement. The colours illustrated in the catalogue are intended only as examples.

PANZERI

PANZERI CARLO S.R.L.
Via Padania, 6/8 - 20853
Biassono MB - Italy
Sede Legale:
Via Mameli, 11 - 20851
Lissone MB - Italy
T +39 039 2497483
F +39 039 2497396
panzeri@panzeri.it
export@panzeri.it
panzeri.it



