

PANZERI

Rally Trim

600mA DC
XR17801.014.2515

● bianco



Scheda tecnica

CODICE ARTICOLO	XR17801.014.2515
POTENZA ASSORBITA DAL SISTEMA	9W
EFFICIENZA LUMINOSA	66.89lm/W
SORGENTE LUMINOSA	LED
TEMPERATURA DI COLORE	3000K Ra>90
DISTRIBUZIONE LUMINOSA	fascio medio
APERTURA DEL FASCIO	30°
ALIMENTAZIONE	600mA DC
DRIVER	remoto non incluso
FLUSSO LUMINOSO NOMINALE	900lm
FLUSSO LUMINOSO USCENTE	602lm
RENDIMENTO	66.9%
PESO	0,24 Kg
GRADO DI PROTEZIONE	IP20
COSTANZA CROMATICA	SDCM <3
DIMENSIONI IMBALLO	0,0 x 0,0 x 0,0 cm

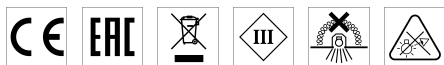

Incasto rettangolare con cornice per ambienti interni, con sorgente luminosa recessa ad emissione diretta composta da lenti LED con fascio 30°.

Struttura per l'incasso in controsoffitti fissi in alluminio pressofuso verniciato grigio ferro.

Disponibile con cornice bianca e ottiche nere, in versione 2700K e 3000K.

Fornito completo di cavo di alimentazione di lunghezza 0,4m (15,7").

Dimensione del foro di incasso: 139x37mm (5,5x1,5").

Disegno tecnico

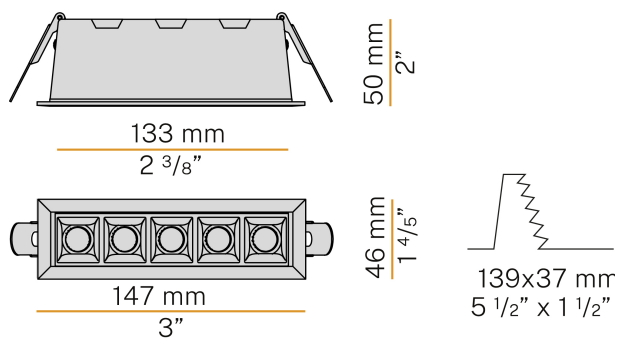

Applicazione



Diagramma polare

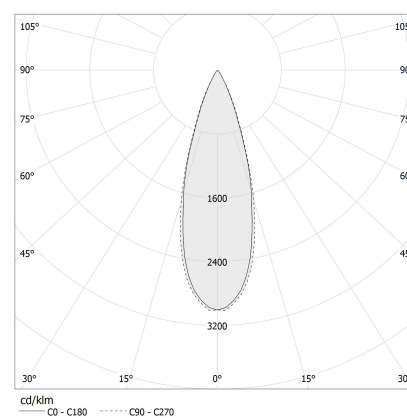

PANZERI

Rally Trim

Accessori alimentazione

XM6-20 D/P MULTI

Alimentatore LED, 9,2÷28W 200÷900mA, dimmerabile 1-10V/DALI/Push DIM.

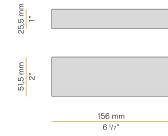

XM6-20 UNI

Alimentatore LED, 4÷20W 250÷700mA.

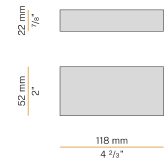

YDR.090.013.A02

Alimentatore LED, 13W 600÷900mA, dimmerabile DALI/Push DIM.

