

PANZERI

Giano

220-240V AC

XP24646.100.0099

 bianco/ schermo opalino



Scheda tecnica

CODICE ARTICOLO	XP24646.100.0099
POTENZA ASSORBITA DAL SISTEMA	max 48W/m
SORGENTE LUMINOSA	LED
DISTRIBUZIONE LUMINOSA	fascio diffuso
ALIMENTAZIONE	220-240V AC
FREQUENZA	50/60Hz
DRIVER	integrato non incluso
PESO	2,35 Kg
GRADO DI PROTEZIONE	IP40
RESISTENZA ALLA PROVA DEL FILO INCANDESCENTE	850°
DIMENSIONI IMBALLO	12,5 x 141,0 x 14,0 cm
L (mm)	1015
L (in)	40"

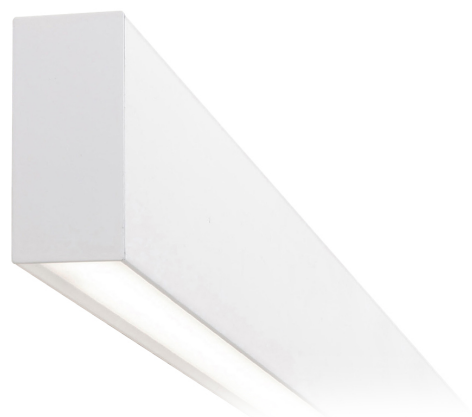

Profilo componibile per installazione a sospensione o a parete in ambienti interni, con emissione diretta e indiretta.

Struttura in alluminio estruso con verniciatura a polvere in colore bianco RAL 9003 o nero.

Schermi diffusori in policarbonato estruso con finitura opalina.

Moduli luminosi e alimentatore da ordinare separatamente.

Schermo diffusore in policarbonato estruso microprismatico da ordinare separatamente.

Accessori di collegamento, fissaggio, giunzione e chiusura da ordinare separatamente.

Disegno tecnico



Diagramma polare



PANZERI

Giano

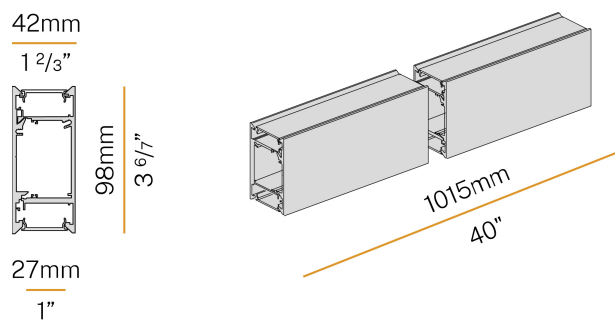
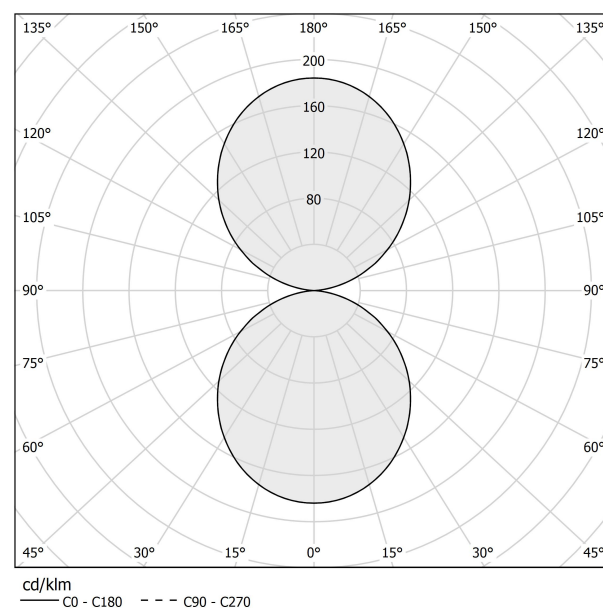
Accessori sorgente

XM006.012.0410 Modulo LED, 125mm (5") 16 LED 2,2W 24V DC 3000K Ra>90 285lm.



XM006.050.0410 Modulo LED, 500mm (19,7") 64 LED 8,6W 24V DC 3000K Ra>90 1140lm.



YLR001.022.0110 Strip LED, 5000mm (196,9") 160 LED/m 21,6W/m 24V DC 3000K Ra>80 3020lm/m, sezionabile ogni 50mm (2").



YLR002.017.0410 Strip LED, 5000mm (196,9") 168 LED/m 17,3W/m 24V DC 3000K Ra>90 1810lm/m, sezionabile ogni 42mm (1,7").



YLR002.017.0610 Strip LED, 5000mm (196,9") 168 LED/m 17,3W/m 24V DC 4000K Ra>90 1920lm/m, sezionabile ogni 42mm (1,7").



YLR003.010.0410 Strip LED, 5000mm (196,9") 168 LED/m 9,6W/m 24V DC 3000K Ra>90 930lm/m, sezionabile ogni 42mm (1,7").



YLR003.010.0510 Strip LED, 5000mm (196,9") 168 LED/m 9,6W/m 24V DC 2700K Ra>90 882lm/m, sezionabile ogni 42mm (1,7").



YLR003.010.0610 Strip LED, 5000mm (196,9") 168 LED/m 9,6W/m 24V DC 4000K Ra>90 980lm/m, sezionabile ogni 42mm (1,7").



PANZERI

Giano

Accessori alimentazione

XM2038/46-3

Kit di alimentazione con rosone bianco, cavo di alimentazione a 3 poli di lunghezza 2,2m (86,6").

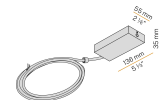

XM2038/46-5

Kit di alimentazione con rosone bianco, cavo di alimentazione a 5 poli di lunghezza 2,2m (86,6").

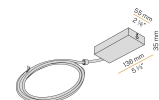

XM60/24I

Alimentatore LED, 60W 24V DC.

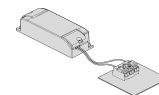

XM60/24I DIM

Alimentatore LED, 60W 24V DC, dimmerabile DALI/Push DIM.

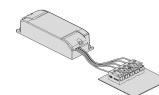

PANZERI

Giano

Accessori diffusione

XM2033/34/45/46-1200S Schermo diffusore in policarbonato estruso con finitura opalina, di lunghezza 12000mm (472,4").

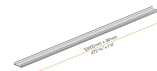

XM2033/34/45/46-1200S PR Schermo diffusore in policarbonato estruso microprismatico, di lunghezza 12000mm (472,4").

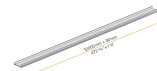

XM2033/34/45/46-600S Schermo diffusore in policarbonato estruso con finitura opalina, di lunghezza 6000mm (236,2").

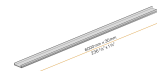

XM2033/34/45/46-600S PR Schermo diffusore in policarbonato estruso microprismatico, di lunghezza 6000mm (236,2").

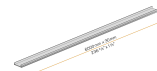

XM2033/34/45/46-900S Schermo diffusore in policarbonato estruso con finitura opalina, di lunghezza 9000mm (354,3").

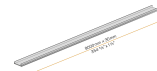

XM2033/34/45/46-900S PR Schermo diffusore in policarbonato estruso microprismatico, di lunghezza 9000mm (354,3").

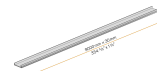

PANZERI

Giano

Accessori fissaggio

XM246-01-KIT-S

Coppia di kit di sospensione, con fune di acciaio di lunghezza 2000mm (78 4/5").

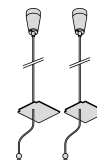

XM246-01-KIT-S1

Kit di sospensione singolo per giunzioni, con fune di acciaio di lunghezza 2000mm (78 4/5").

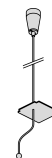

PANZERI

Giano

Accessori giunzione

XM246-U

Kit di giunzione lineare.



PANZERI

Giano

Accessori chiusura

XM246-01T

Coppia di testate di chiusura.

