

Brooklyn

24V DC
XG2033-100TRACK

 bianco/schermo opalino



Scheda tecnica

CODICE ARTICOLO	XG2033-100TRACK
POTENZA ASSORBITA DAL SISTEMA	max 24W/m
SORGENTE LUMINOSA	LED
DISTRIBUZIONE LUMINOSA	fascio diffuso
ALIMENTAZIONE	24V DC
DRIVER	remoto non incluso
PESO	0,83 Kg
GRADO DI PROTEZIONE	IP40 IP20
INDICE DI RESISTENZA AGLI URTI	IK08
RESISTENZA ALLA PROVA DEL FILO INCANDESCENTE	850°
DIMENSIONI IMBALLO	6,0 x 6,0 x 114,0 cm
L (mm)	1010
L (in)	39 4/5"
STAFFE CONSIGLIATE	2
FORO (mm)	1015 x 40
FORO (in)	40" x 1 3/8"



Profilo componibile per installazione incassata a soffitto o parete in ambienti interni, con emissione diretta.

Struttura a scomparsa per l'incasso in cartongesso, in alluminio estruso con verniciatura a polvere in colore bianco RAL 9003.

Schermo diffusore in policarbonato estruso con finitura opalina.

Fornito completo di schermo monouso per rasatura, stuccatura e verniciatura della superficie di installazione.

Moduli luminosi e alimentatore da ordinare separatamente.

Accessori di fissaggio, giunzione e chiusura da ordinare separatamente.

Dimensione del foro di incasso: 1015x40mm (40x1,6")

Disegno tecnico

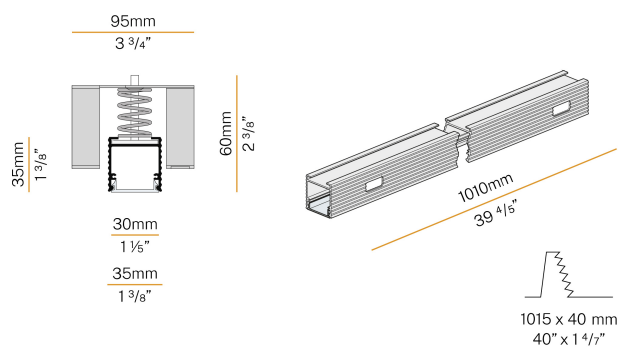

Applicazione



Diagramma polare

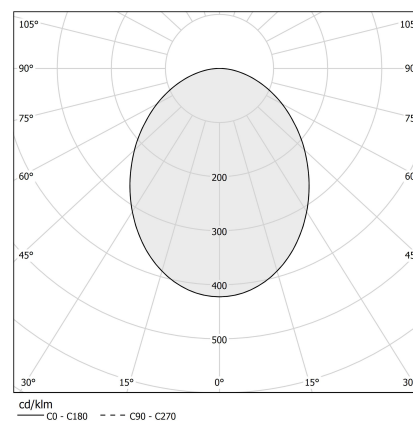

PANZERI

Brooklyn

Accessori sorgente

XM006.012.0410

Modulo LED, 125mm (5") 16 LED 2,2W 24V DC 3000K Ra>90 285lm.



XM006.050.0410

Modulo LED, 500mm (19,7") 64 LED 8,6W 24V DC 3000K Ra>90 1140lm.



PANZERI

Brooklyn

Accessori alimentazione

XM100/24 DIM

Alimentatore LED, 100W 24V DC, dimmerabile DALI/Push DIM.

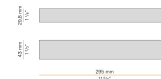

XM150/24 DIM

Alimentatore LED, 150W 24V DC, dimmerabile DALI/Push DIM.



XM18/24 DIM

Alimentatore LED, 18W 24V DC, dimmerabile DALI/Push DIM.

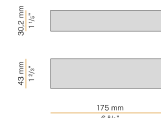

XM35/24 DIM

Alimentatore LED, 35W 24V DC, dimmerabile DALI/Push DIM.

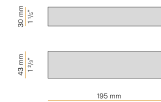

XM6-20 UNI

Alimentatore LED, 4x20W 250÷700mA.

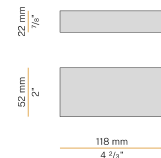

XM60/24 DIM

Alimentatore LED, 60W 24V DC, dimmerabile DALI/Push DIM.



YDV.024.030.A01

Alimentatore LED, 30W 24V DC.

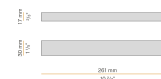

YDV.024.120.A01

Alimentatore LED, 120W 24V DC.

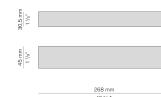

YDV.024.180.A01

Alimentatore LED, 180W 24V DC.

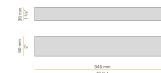

PANZERI

Brooklyn

Accessori connessione

XM2033/34/32/31-S

Cavi di alimentazione.



PANZERI

Brooklyn

Accessori diffusione

XM2033/34-WHI

Riflettore bianco di lunghezza 1000mm (39,4") sezionabile.



XM2033/34/45/46-1200S

Schermo diffusore in policarbonato estruso con finitura opalina, di lunghezza 12000mm (472,4").

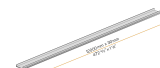

XM2033/34/45/46-600S

Schermo diffusore in policarbonato estruso con finitura opalina, di lunghezza 6000mm (236,2").

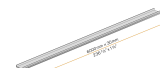

XM2033/34/45/46-900S

Schermo diffusore in policarbonato estruso con finitura opalina, di lunghezza 9000mm (354,3").

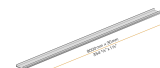

PANZERI

Brooklyn

Accessori fissaggio

XM2033-F

Farfalla di fissaggio su cartongesso per profili incassati a scomparsa.

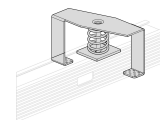

XM2033/34-L

Coppia di piastrine di fissaggio per incasso in muratura.



XM2033/34/38/39P

Piastrina per appendimento.

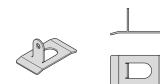

PANZERI

Brooklyn

Accessori giunzione

XM2033-U45

Giunzione piana per due profili con taglio a 45°, per installazione a incasso a scomparsa.

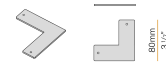

XM2033-U90

Elemento di collegamento per due linee di profili componibili con angolo di giunzione piano di 90°, per installazione a incasso a scomparsa.

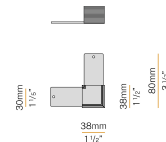

XM2033-UT

Giunzione piana per tre profili a "T", per installazione a incasso a scomparsa.



XM2033-X

Giunzione piana per quattro profili a "X", per installazione a incasso a scomparsa.



XM2033/34-ANG

Giunzione perpendicolare per due profili con taglio a 45°.

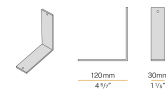

XM2033/34-U

Giunzione lineare.

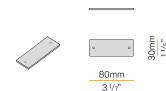

PANZERI

Brooklyn

Accessori chiusura

XM2033-T

Coppia di testate di chiusura con viti per profili incassati a scomparsa.

