

PANZERI

Bella

24V DC
M05301.011.0510

● bianco



Scheda tecnica

| | |
|-------------------------------|-----------------------|
| CODICE ARTICOLO | M05301.011.0510 |
| POTENZA ASSORBITA DAL SISTEMA | 4,5W |
| EFFICIENZA LUMINOSA | 97lm/W |
| SORGENTE LUMINOSA | LED |
| DURATA DI VITA DELLA SORGENTE | L80 (B10) 70.000h |
| TEMPERATURA DI COLORE | 2700K Ra>90 |
| DISTRIBUZIONE LUMINOSA | fascio diffuso |
| ALIMENTAZIONE | 24V DC |
| DRIVER | remoto non incluso |
| FLUSSO LUMINOSO NOMINALE | 460lm |
| FLUSSO LUMINOSO USCENTE | 388lm |
| RENDIMENTO | 84.3% |
| PESO | 0,22 Kg |
| GRADO DI PROTEZIONE | IP40 |
| COSTANZA CROMATICA | SDCM 3 |
| DIMENSIONI IMBALLO | 13,0 x 24,0 x 12,0 cm |



Apparecchio di illuminazione per installazioni multiple a sospensione in ambienti interni, con emissione indiretta.

Struttura in alluminio pressofuso con verniciatura poliacrilica in colore bianco, nero, bronzo, ottone satinato o titanio.

Schermo diffusore in materiale acrilico sagomato con finitura satinata.

Piattello di chiusura in lamiera decapata con verniciatura poliacrilica.

Kit di sospensione con tige in tubo di ottone con verniciatura poliacrilica.

Cavo di alimentazione e sospensione coassiale in PVC trasparente di lunghezza 3m (118,1").

Fornito senza rosone di alimentazione, completo di bloccacavo all'estremità libera del cavo.

Disegno tecnico

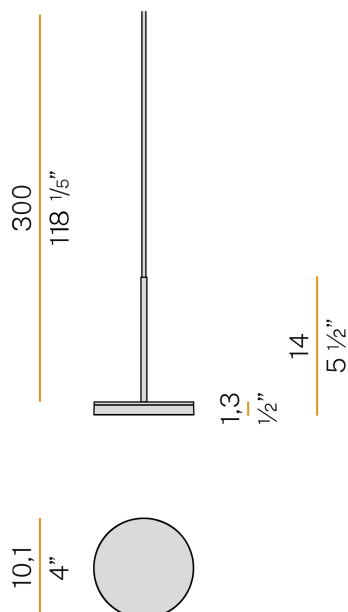

PANZERI

Bella

Accessori alimentazione

XM100/24 DIM

Alimentatore LED, 100W 24V DC, dimmerabile DALI/Push DIM.

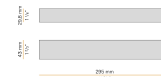

XM150/24 DIM

Alimentatore LED, 150W 24V DC, dimmerabile DALI/Push DIM.



XM18/24 DIM

Alimentatore LED, 18W 24V DC, dimmerabile DALI/Push DIM.

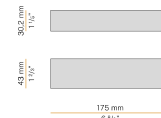

XM35/24 DIM

Alimentatore LED, 35W 24V DC, dimmerabile DALI/Push DIM.

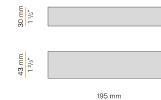

XM6-20 UNI

Alimentatore LED, 4x20W 250÷700mA.

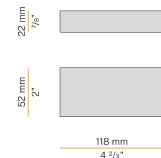

XM60/24 DIM

Alimentatore LED, 60W 24V DC, dimmerabile DALI/Push DIM.



YDV.024.030.A01

Alimentatore LED, 30W 24V DC.

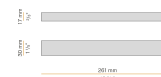

YDV.024.120.A01

Alimentatore LED, 120W 24V DC.

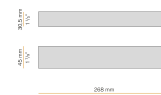

YDV.024.180.A01

Alimentatore LED, 180W 24V DC.

