

PANZERI

Zero Round

24V DC

M03319.100.0510

 ottone satinato



Scheda tecnica

| | |
|-------------------------------|-------------------------|
| CODICE ARTICOLO | M03319.100.0510 |
| POTENZA ASSORBITA DAL SISTEMA | 47W |
| EFFICIENZA LUMINOSA | 86.79lm/W |
| SORGENTE LUMINOSA | LED |
| DURATA DI VITA DELLA SORGENTE | L70 (B50) 60.000h |
| TEMPERATURA DI COLORE | 2700K Ra>90 |
| DISTRIBUZIONE LUMINOSA | fascio diffuso |
| ALIMENTAZIONE | 24V DC |
| DRIVER | remoto non incluso |
| FLUSSO LUMINOSO NOMINALE | 5670lm |
| FLUSSO LUMINOSO USCENTE | 4079lm |
| RENDIMENTO | 71.9% |
| PESO | 1,43 Kg |
| GRADO DI PROTEZIONE | IP20 |
| COSTANZA CROMATICA | SDCM 3 |
| DIMENSIONI IMBALLO | 107,0 x 107,0 x 11,0 cm |



Apparecchio di illuminazione per installazioni singole o multiple a sospensione in ambienti interni, con emissione diretta e indiretta.
Struttura in alluminio estruso curvato con verniciatura poliacrilica in colore bianco, nero, bronzo, ottone satinato o titanio.
Schermo diffusore in policarbonato estruso con finitura opalina.
Kit di sospensione con dispositivi di regolazione rapida e funi in acciaio di lunghezza 5m (196,9").
Cavo di alimentazione in PVC trasparente di lunghezza 5m (196,9").
Fornito senza rosone di alimentazione.

Disegno tecnico



Diagramma polare



PANZERI

Zero Round

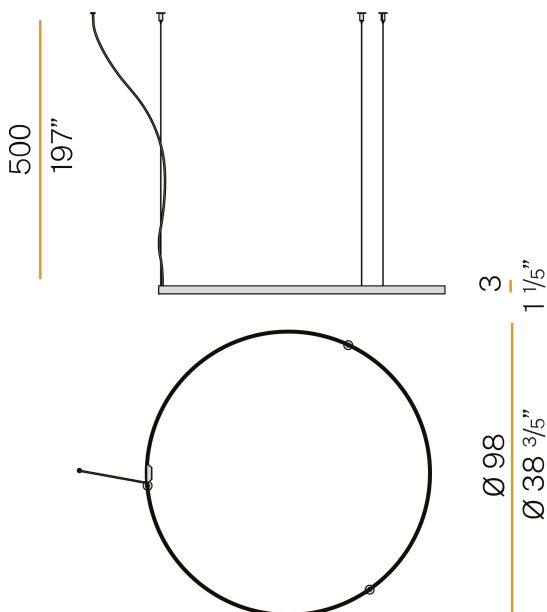
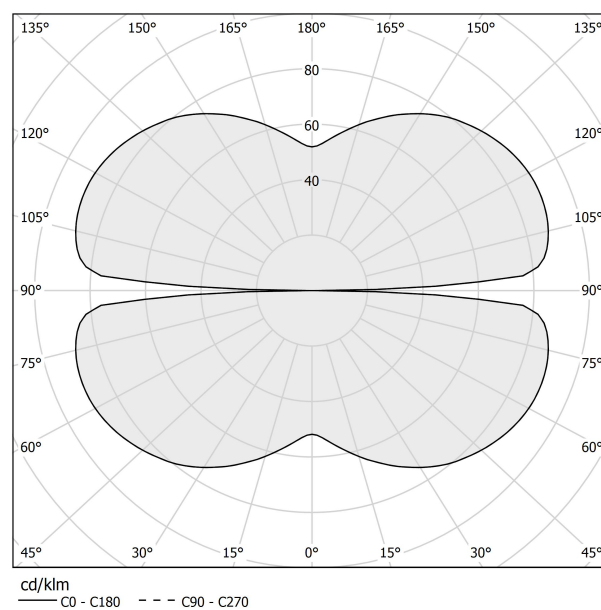
Accessori alimentazione

XM03319.511.0002

Rosone per alimentazione di 1 modello Zero Shapes, con driver DALI/Push DIM.



4,1
1 7/8"



20,6
8 1/8"

XM03319.522.0002

Rosone per alimentazione di 2 modelli Zero Shapes, con driver DALI/Push DIM.



9,8
3 13/16"



32,5
12 1/4"

XM03319.523.0002

Rosone per alimentazione di 3 modelli Zero Shapes, con driver DALI/Push DIM.



9,8
3 13/16"



32,5
12 1/4"

XM03319.524.0002

Rosone per alimentazione di 4 modelli Zero Shapes, con driver DALI/Push DIM.



9,8
3 13/16"













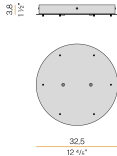



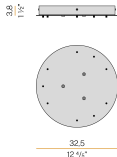



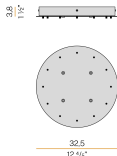



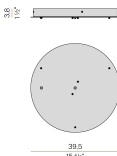

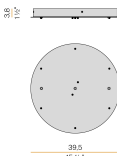

32,5
12 1/4"

PANZERI

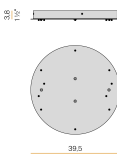
Zero Round

Accessori alimentazione e fissaggio

| | | |
|---|---|---|
| XM03319.531.0002 | Rosone per alimentazione e sospensione di 1 modello Zero Shapes Horizontal, con driver DALI/Push DIM. |  |
|     | | |
| XM03319.532.0002 | Rosone per alimentazione e sospensione di 2 modelli Zero Shapes Horizontal, con driver DALI/Push DIM. |  |
|     | | |
| XM03319.533.0002 | Rosone per alimentazione e sospensione di 3 modelli Zero Shapes Horizontal, con driver DALI/Push DIM. |  |
|     | | |
| XM03319.534.0002 | Rosone per alimentazione e sospensione di 4 modelli Zero Shapes Horizontal, con driver DALI/Push DIM. |  |
|     | | |
| XM03419.552.0002 | Rosone per alimentazione e sospensione di 1 modello Zero Shapes Horizontal e 1 modello Zero Round Vertical, con driver DALI/Push DIM. |  |
|     | | |
| XM03419.553.0002 | Rosone per alimentazione e sospensione di 2 modelli Zero Shapes Horizontal e 1 modello Zero Round Vertical, con driver DALI/Push DIM. |  |
|     | | |
| XM03419.554.0002 | Rosone per alimentazione e sospensione di 2 modelli Zero Shapes Horizontal e 2 modelli Zero Round Vertical, con driver DALI/Push DIM. |  |
|     | | |