

# PANZERI

## Zero Round

24V DC

M03319.075.0410

 ottone satinato



### Scheda tecnica

CODICE ARTICOLO	M03319.075.0410
POTENZA ASSORBITA DAL SISTEMA	36W
EFFICIENZA LUMINOSA	84.97lm/W
SORGENTE LUMINOSA	LED
DURATA DI VITA DELLA SORGENTE	L70 (B50) 60.000h
TEMPERATURA DI COLORE	3000K Ra>90
DISTRIBUZIONE LUMINOSA	fascio diffuso
ALIMENTAZIONE	24V DC
DRIVER	remoto non incluso
FLUSSO LUMINOSO NOMINALE	4252lm
FLUSSO LUMINOSO USCENTE	3059lm
RENDIMENTO	71.9%
PESO	1,12 Kg
GRADO DI PROTEZIONE	IP20
COSTANZA CROMATICA	SDCM 3
DIMENSIONI IMBALLO	83,0 x 83,0 x 10,0 cm



Apparecchio di illuminazione per installazioni singole o multiple a sospensione in ambienti interni, con emissione diretta e indiretta.  
Struttura in alluminio estruso curvato con verniciatura poliacrilica in colore bianco, nero, bronzo, ottone satinato o titanio.  
Schermo diffusore in policarbonato estruso con finitura opalina.  
Kit di sospensione con dispositivi di regolazione rapida e funi in acciaio di lunghezza 5m (196,9").  
Cavo di alimentazione in PVC trasparente di lunghezza 5m (196,9").  
Fornito senza rosone di alimentazione.

### Disegno tecnico

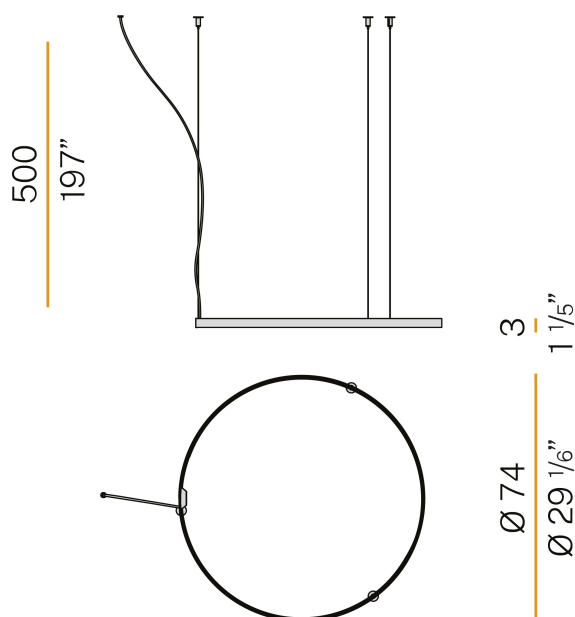

### Diagramma polare

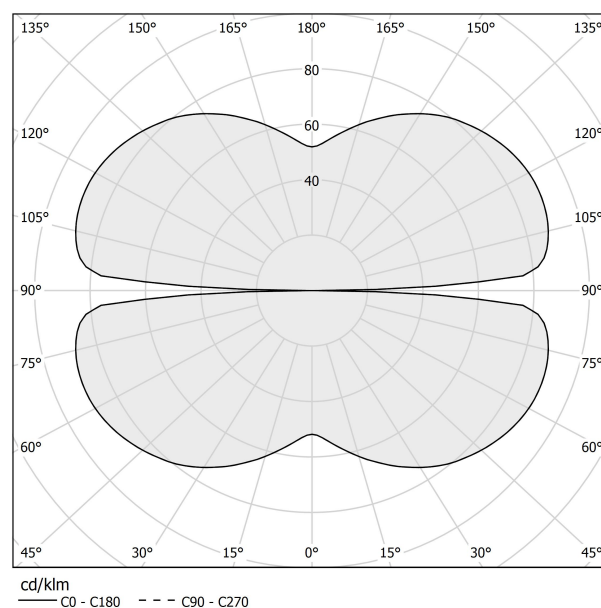

# PANZERI

## Zero Round

### Accessori alimentazione

XM03319.511.0002 Rosone per alimentazione di 1 modello Zero Shapes, con driver DALI/Push DIM.



4,1  
1 7/8"



20,6  
8 1/8"

XM03319.522.0002 Rosone per alimentazione di 2 modelli Zero Shapes, con driver DALI/Push DIM.



9,8  
1 1/2"



32,5  
12 5/8"

XM03319.523.0002 Rosone per alimentazione di 3 modelli Zero Shapes, con driver DALI/Push DIM.



9,8  
1 1/2"



32,5  
12 5/8"

XM03319.524.0002 Rosone per alimentazione di 4 modelli Zero Shapes, con driver DALI/Push DIM.



9,8  
1 1/2"











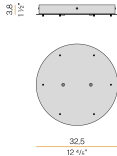

32,5  
12 5/8"

# PANZERI

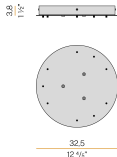
## Zero Round

### Accessori alimentazione e fissaggio

XM03319.531.0002	Rosone per alimentazione e sospensione di 1 modello Zero Shapes Horizontal, con driver DALI/Push DIM.	  4.1 1/8" 20.6 8 1/16"
XM03319.532.0002	Rosone per alimentazione e sospensione di 2 modelli Zero Shapes Horizontal, con driver DALI/Push DIM.	  3.8 1/8" 32.5 1 1/4"
XM03319.533.0002	Rosone per alimentazione e sospensione di 3 modelli Zero Shapes Horizontal, con driver DALI/Push DIM.	  3.8 1/8" 32.5 1 1/4"
XM03319.534.0002	Rosone per alimentazione e sospensione di 4 modelli Zero Shapes Horizontal, con driver DALI/Push DIM.	  3.8 1/8" 32.5 1 1/4"
XM03419.552.0002	Rosone per alimentazione e sospensione di 1 modello Zero Shapes Horizontal e 1 modello Zero Round Vertical, con driver DALI/Push DIM.	  3.8 1/8" 39.5 1 5/16"
XM03419.553.0002	Rosone per alimentazione e sospensione di 2 modelli Zero Shapes Horizontal e 1 modello Zero Round Vertical, con driver DALI/Push DIM.	  3.8 1/8" 39.5 1 5/16"
XM03419.554.0002	Rosone per alimentazione e sospensione di 2 modelli Zero Shapes Horizontal e 2 modelli Zero Round Vertical, con driver DALI/Push DIM.	  3.8 1/8" 39.5 1 5/16"