

PANZERI

Zero Round

24V DC

M03302.075.0410



Scheda tecnica

CODICE ARTICOLO	M03302.075.0410
POTENZA ASSORBITA DAL SISTEMA	36W
EFFICIENZA LUMINOSA	84.97lm/W
SORGENTE LUMINOSA	LED
DURATA DI VITA DELLA SORGENTE	L70 (B50) 60.000h
TEMPERATURA DI COLORE	3000K Ra>90
DISTRIBUZIONE LUMINOSA	fascio diffuso
ALIMENTAZIONE	24V DC
DRIVER	remoto non incluso
FLUSSO LUMINOSO NOMINALE	4252lm
FLUSSO LUMINOSO USCENTE	3059lm
RENDIMENTO	71.9%
PESO	1,12 Kg
GRADO DI PROTEZIONE	IP20
COSTANZA CROMATICA	SDCM 3
DIMENSIONI IMBALLO	83,0 x 83,0 x 10,0 cm

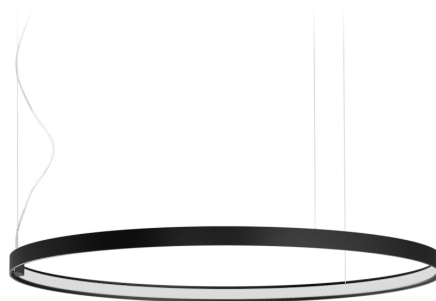

Apparecchio di illuminazione per installazioni singole o multiple a sospensione in ambienti interni, con emissione diretta e indiretta.
Struttura in alluminio estruso curvato con verniciatura poliacrilica in colore bianco, nero, bronzo, ottone satinato o titanio.
Schermo diffusore in policarbonato estruso con finitura opalina.
Kit di sospensione con dispositivi di regolazione rapida e funi in acciaio di lunghezza 5m (196,9").
Cavo di alimentazione in PVC trasparente di lunghezza 5m (196,9").
Fornito senza rosone di alimentazione.

Disegno tecnico



Diagramma polare



PANZERI

Zero Round

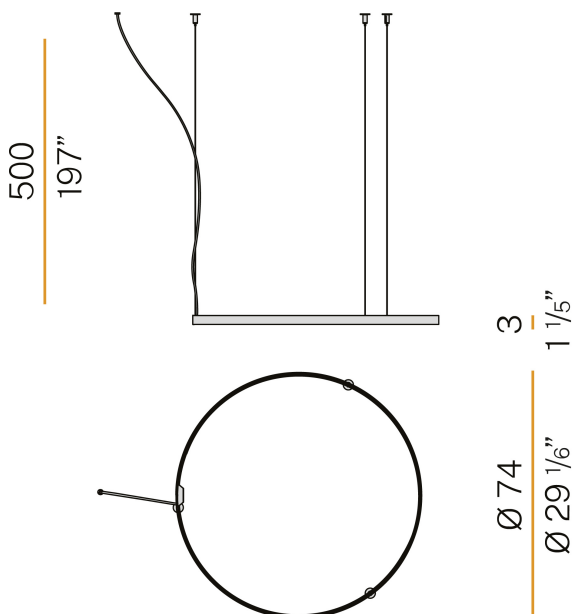
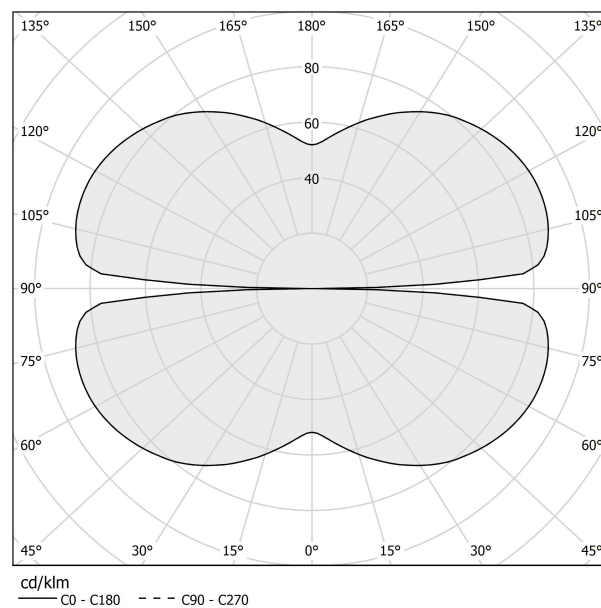
Accessori alimentazione

XM03302.511.0002

Rosone per alimentazione di 1 modello Zero Shapes, con driver DALI/Push DIM.



4,1
1 7/8"



20,6
8 1/8"

XM03302.522.0002

Rosone per alimentazione di 2 modelli Zero Shapes, con driver DALI/Push DIM.



9,8
1 1/2"



32,5
1 2 1/4"

XM03302.523.0002

Rosone per alimentazione di 3 modelli Zero Shapes, con driver DALI/Push DIM.



9,8
1 1/2"



32,5
1 2 1/4"

XM03302.524.0002

Rosone per alimentazione di 4 modelli Zero Shapes, con driver DALI/Push DIM.



9,8
1 1/2"











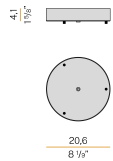



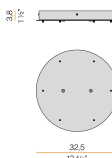



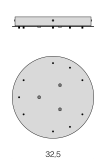



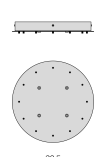

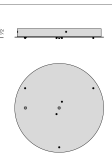

32,5
1 2 1/4"

PANZERI

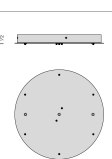
Zero Round

Accessori alimentazione e fissaggio

XM03302.531.0002	Rosone per alimentazione e sospensione di 1 modello Zero Shapes Horizontal, con driver DALI/Push DIM.	
   		
XM03302.532.0002	Rosone per alimentazione e sospensione di 2 modelli Zero Shapes Horizontal, con driver DALI/Push DIM.	
   		
XM03302.533.0002	Rosone per alimentazione e sospensione di 3 modelli Zero Shapes Horizontal, con driver DALI/Push DIM.	
   		
XM03302.534.0002	Rosone per alimentazione e sospensione di 4 modelli Zero Shapes Horizontal, con driver DALI/Push DIM.	
   		
XM03402.552.0002	Rosone per alimentazione e sospensione di 1 modello Zero Shapes Horizontal e 1 modello Zero Round Vertical, con driver DALI/Push DIM.	
   		
XM03402.553.0002	Rosone per alimentazione e sospensione di 2 modelli Zero Shapes Horizontal e 1 modello Zero Round Vertical, con driver DALI/Push DIM.	
   		
XM03402.554.0002	Rosone per alimentazione e sospensione di 2 modelli Zero Shapes Horizontal e 2 modelli Zero Round Vertical, con driver DALI/Push DIM.	