

# PANZERI

## Zero Square

24V DC

M03230.075.0510

titanio



### Scheda tecnica

CODICE ARTICOLO	M03230.075.0510
POTENZA ASSORBITA DAL SISTEMA	36W
EFFICIENZA LUMINOSA	84.97lm/W
SORGENTE LUMINOSA	LED
DURATA DI VITA DELLA SORGENTE	L70 (B50) 60.000h
TEMPERATURA DI COLORE	2700K Ra>90
DISTRIBUZIONE LUMINOSA	fascio diffuso
ALIMENTAZIONE	24V DC
DRIVER	remoto non incluso
FLUSSO LUMINOSO NOMINALE	4252lm
FLUSSO LUMINOSO USCENTE	3059lm
RENDIMENTO	71.9%
PESO	1,21 Kg
GRADO DI PROTEZIONE	IP20
COSTANZA CROMATICA	SDCM 3
DIMENSIONI IMBALLO	83,0 x 83,0 x 10,0 cm



Apparecchio di illuminazione per installazioni singole o multiple a sospensione in ambienti interni, con emissione diretta e indiretta.  
Struttura in alluminio estruso curvato con verniciatura poliacrilica in colore bianco, nero, bronzo, ottone satinato o titanio.  
Schermo diffusore in policarbonato estruso con finitura opalina.  
Kit di sospensione con dispositivi di regolazione rapida e funi in acciaio di lunghezza 5m (196,9").  
Cavo di alimentazione in PVC trasparente di lunghezza 5m (196,9").  
Fornito senza rosone di alimentazione.

### Disegno tecnico

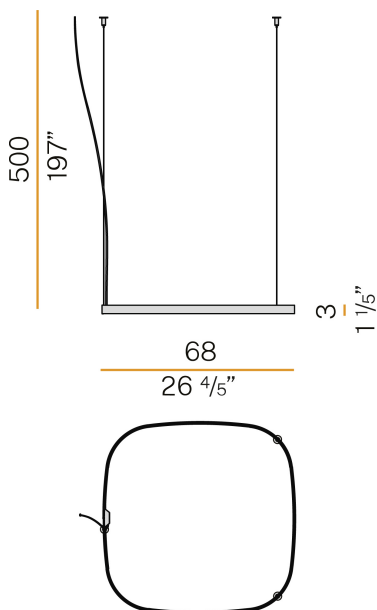

### Diagramma polare

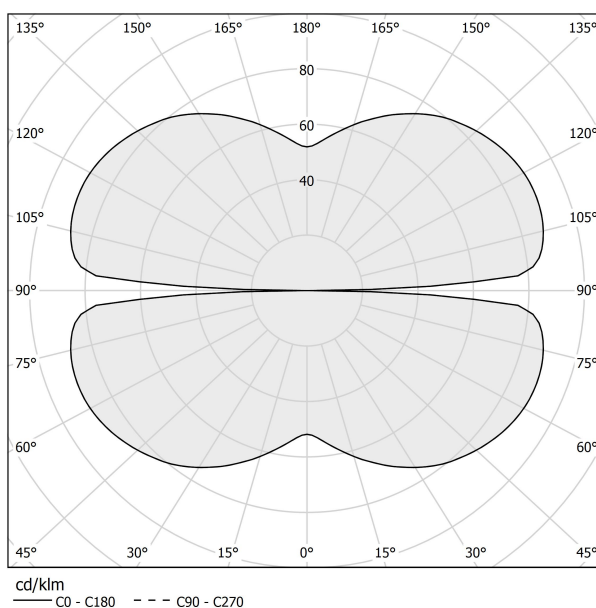

# PANZERI

## Zero Square

### Accessori alimentazione

XM03330.511.0002

Rosone per alimentazione di 1 modello Zero Shapes, con driver DALI/Push DIM.



4,1  
1 9/16"



20,6  
8 1/8"

XM03330.522.0002

Rosone per alimentazione di 2 modelli Zero Shapes, con driver DALI/Push DIM.



9,8  
1 1/2"



32,5  
1 2 1/4"

XM03330.523.0002

Rosone per alimentazione di 3 modelli Zero Shapes, con driver DALI/Push DIM.



9,8  
1 1/2"



32,5  
1 2 1/4"

XM03330.524.0002

Rosone per alimentazione di 4 modelli Zero Shapes, con driver DALI/Push DIM.



9,8  
1 1/2"











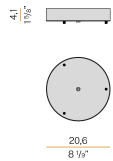



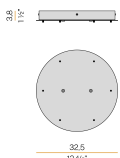



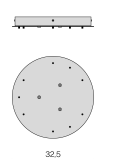



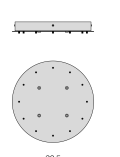

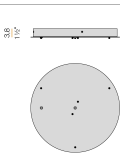

32,5  
1 2 1/4"

# PANZERI

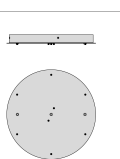
## Zero Square

### Accessori alimentazione e fissaggio

XM03330.531.0002	Rosone per alimentazione e sospensione di 1 modello Zero Shapes Horizontal, con driver DALI/Push DIM.	
   		
XM03330.532.0002	Rosone per alimentazione e sospensione di 2 modelli Zero Shapes Horizontal, con driver DALI/Push DIM.	
   		
XM03330.533.0002	Rosone per alimentazione e sospensione di 3 modelli Zero Shapes Horizontal, con driver DALI/Push DIM.	
   		
XM03330.534.0002	Rosone per alimentazione e sospensione di 4 modelli Zero Shapes Horizontal, con driver DALI/Push DIM.	
   		
XM03430.552.0002	Rosone per alimentazione e sospensione di 1 modello Zero Shapes Horizontal e 1 modello Zero Round Vertical, con driver DALI/Push DIM.	
   		
XM03430.553.0002	Rosone per alimentazione e sospensione di 2 modelli Zero Shapes Horizontal e 1 modello Zero Round Vertical, con driver DALI/Push DIM.	
   		
XM03430.554.0002	Rosone per alimentazione e sospensione di 2 modelli Zero Shapes Horizontal e 2 modelli Zero Round Vertical, con driver DALI/Push DIM.	