

# PANZERI

## Giano

220-240V AC

XP24648.100.0099

 noir/écran opale



### Fiche technique

CODE	XP24648.100.0099
CONSUMMATION éLECTRIQUE DU SYSTèME	max 48W/m
SOURCE DE LUMIèRE	LED
DISTRIBUTION LUMINEUSE	faisceau diffus
ALIMENTATION éLECTRIQUE	220-240V AC
FRéQUENCE	50/60Hz
ALIMENTATION	intégré non inclus
POIDS	2,35 Kg
DEGRé DE PROTECTION	IP40
RéSISTANCE AU TEST DU FIL INCANDESCENT	850°
DIMENSIONS DE L'EMBALLAGE	12,5 x 141,0 x 14,0 cm
L (mm)	1015
L (in)	40"

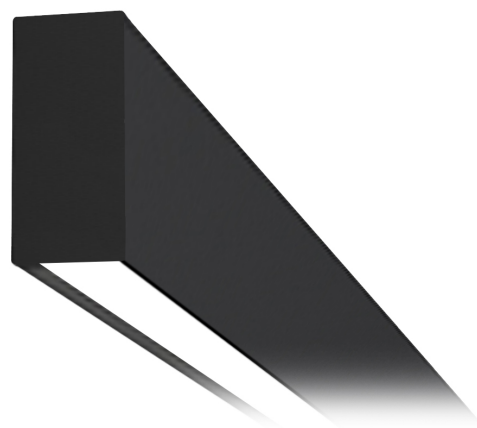

Profilé modulaire d'intérieur pour suspension ou installation murale, avec émission directe et indirecte.

Structure en aluminium extrudé avec revêtement par poudre en blanc RAL 9003 ou noir. Écrans diffuseurs en polycarbonate extrudé avec finition opaline.

Modules lumineux et alimentation à commander séparément.

Écran diffuseur en polycarbonate extrudé microprismatique à commander séparément.

Accessoires de raccordement, de fixation, d'assemblage et de fermeture à commander séparément.

### Dessin technique

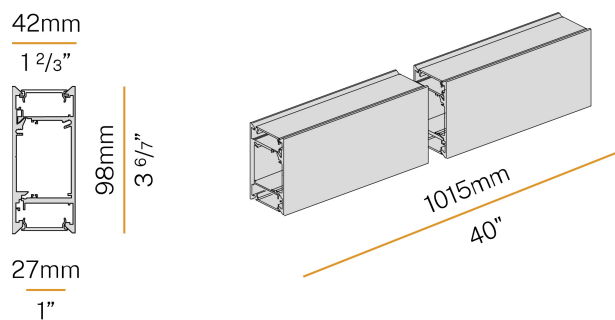

### Diagramme polaire

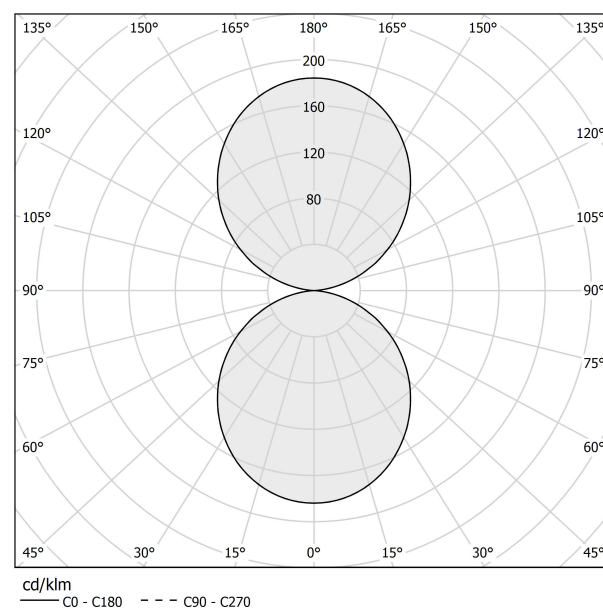

# PANZERI

## Giano

### Accessories / source

XM006.012.0410

Module LED, 125mm (5") 16 LED 2,2W 24V DC 3000K Ra>90 285lm.



XM006.050.0410

Module LED, 500mm (19,7") 64 LED 8,6W 24V DC 3000K Ra>90 1140lm.



YLR001.022.0110

Bande LED, 5000mm (196,9") 160 LED/m 21,6W/m 24V DC 3000K Ra>80 3020lm/m, sectionnable tous les 50mm (2").



YLR002.017.0410

Bande LED, 5000mm (196,9") 168 LED/m 17,3W/m 24V DC 3000K Ra>90 1810lm/m, sectionnable tous les 42mm (1,7").



YLR002.017.0610

Bande LED, 5000mm (196,9") 168 LED/m 17,3W/m 24V DC 4000K Ra>90 1920lm/m, sectionnable tous les 42mm (1,7").



YLR003.010.0410

Bande LED, 5000mm (196,9") 168 LED/m 9,6W/m 24V DC 3000K Ra>90 930lm/m, sectionnable tous les 42mm (1,7").



YLR003.010.0510

Bande LED, 5000mm (196,9") 168 LED/m 9,6W/m 24V DC 2700K Ra>90 882lm/m, sectionnable tous les 42mm (1,7").



YLR003.010.0610

Bande LED, 5000mm (196,9") 168 LED/m 9,6W/m 24V DC 4000K Ra>90 980lm/m, sectionnable tous les 42mm (1,7").



# PANZERI

## Giano

### Accessories / alimentation

XM2038/46-3

Kit d'alimentation avec platine blanche et câble d'alimentation à 3 pôles longueur 2,2m (86,6").

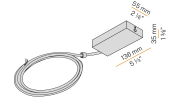

XM2038/46-5

Kit d'alimentation avec platine blanche et câble d'alimentation à 5 pôles longueur 2,2m (86,6").

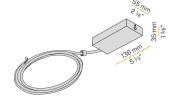

XM60/24I

Alimentation LED, 60W 24V DC.

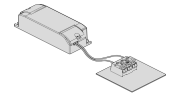

XM60/24I DIM

Alimentation LED, 60W 24V DC, dimmable DALI/Push DIM.

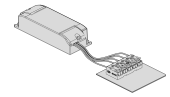

# PANZERI

## Giano

### Accessories / diffusion

XM2033/34/45/46-1200S Écran diffuseur en polycarbonate extrudé avec finition opaline, longueur 12000mm (472,4").

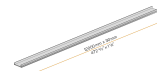

XM2033/34/45/46-1200S PR Écran diffuseur en polycarbonate extrudé microprismatique, longueur 12000mm (472,4").

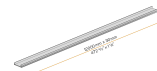

XM2033/34/45/46-600S Écran diffuseur en polycarbonate extrudé avec finition opaline, longueur 6000mm (236,2").

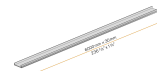

XM2033/34/45/46-600S PR Écran diffuseur en polycarbonate extrudé microprismatique, longueur 6000mm (236,2").

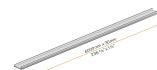

XM2033/34/45/46-900S Écran diffuseur en polycarbonate extrudé avec finition opaline, longueur 9000mm (354,3").

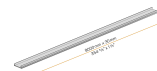

XM2033/34/45/46-900S PR Écran diffuseur en polycarbonate extrudé microprismatique, longueur 9000mm (354,3").

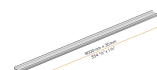

# PANZERI

Giano

## Accessories / fixation

XM246-02-KIT-S

Paire de kit de suspension, avec câble en acier d'une longueur de 2000mm (78 4/5").

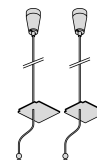
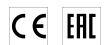

XM246-02-KIT-S1

Kit de suspension individuel pour raccords, avec câble en acier d'une longueur de 2000mm (78 4/5").



# PANZERI

Giano

## Accessories / jonction

XM246-U

Kit de raccord linéaire.



# PANZERI

Giano

## Accessories / fermeture

XM246-02T

Paire d'embouts.

