

PANZERI

Giano

220-240V AC

XP24646.100.0099

blanc/écran opale



Fiche technique

CODE	XP24646.100.0099
CONSUMMATION éLECTRIQUE DU SYSTèME	max 48W/m
SOURCE DE LUMIèRE	LED
DISTRIBUTION LUMINEUSE	faisceau diffus
ALIMENTATION éLECTRIQUE	220-240V AC
FRéQUENCE	50/60Hz
ALIMENTATION	intégré non inclus
POIDS	2,35 Kg
DEGRé DE PROTECTION	IP40
RéSISTANCE AU TEST DU FIL INCANDESCENT	850°
DIMENSIONS DE L'EMBALLAGE	12,5 x 141,0 x 14,0 cm
L (mm)	1015
L (in)	40"

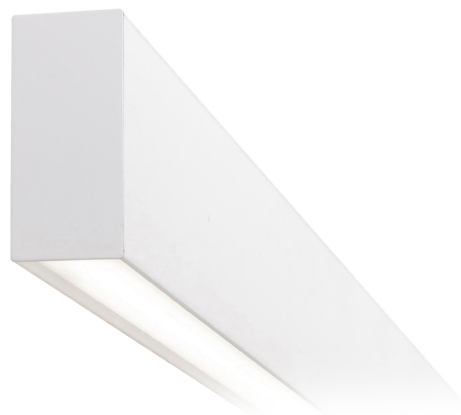

Profilé modulaire d'intérieur pour suspension ou installation murale, avec émission directe et indirecte.
Structure en aluminium extrudé avec revêtement par poudre en blanc RAL 9003 ou noir.
Écrans diffuseurs en polycarbonate extrudé avec finition opaline.
Modules lumineux et alimentation à commander séparément.
Écran diffuseur en polycarbonate extrudé microprismatique à commander séparément.
Accessoires de raccordement, de fixation, d'assemblage et de fermeture à commander séparément.

Dessin technique



Diagramme polaire



PANZERI

Giano

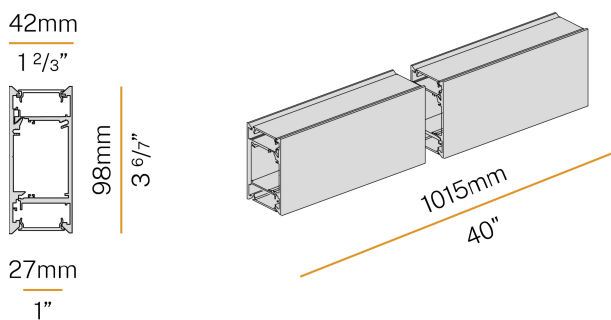
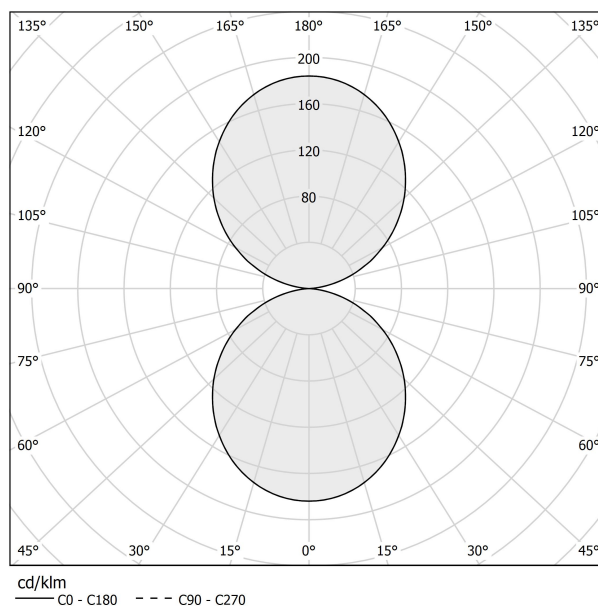
Accessories / source

XM006.012.0410 Module LED, 125mm (5") 16 LED 2,2W 24V DC 3000K Ra>90 285lm.



XM006.050.0410 Module LED, 500mm (19,7") 64 LED 8,6W 24V DC 3000K Ra>90 1140lm.



YLR001.022.0110 Bande LED, 5000mm (196,9") 160 LED/m 21,6W/m 24V DC 3000K Ra>80 3020lm/m, sectionnable tous les 50mm (2").



YLR002.017.0410 Bande LED, 5000mm (196,9") 168 LED/m 17,3W/m 24V DC 3000K Ra>90 1810lm/m, sectionnable tous les 42mm (1,7").



YLR002.017.0610 Bande LED, 5000mm (196,9") 168 LED/m 17,3W/m 24V DC 4000K Ra>90 1920lm/m, sectionnable tous les 42mm (1,7").



YLR003.010.0410 Bande LED, 5000mm (196,9") 168 LED/m 9,6W/m 24V DC 3000K Ra>90 930lm/m, sectionnable tous les 42mm (1,7").



YLR003.010.0510 Bande LED, 5000mm (196,9") 168 LED/m 9,6W/m 24V DC 2700K Ra>90 882lm/m, sectionnable tous les 42mm (1,7").



YLR003.010.0610 Bande LED, 5000mm (196,9") 168 LED/m 9,6W/m 24V DC 4000K Ra>90 980lm/m, sectionnable tous les 42mm (1,7").



PANZERI

Giano

Accessories / alimentation

XM2038/46-3

Kit d'alimentation avec platine blanche et câble d'alimentation à 3 pôles longueur 2,2m (86,6").

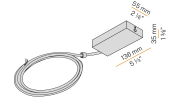

XM2038/46-5

Kit d'alimentation avec platine blanche et câble d'alimentation à 5 pôles longueur 2,2m (86,6").

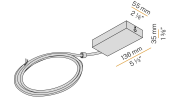

XM60/24I

Alimentation LED, 60W 24V DC.

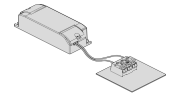

XM60/24I DIM

Alimentation LED, 60W 24V DC, dimmable DALI/Push DIM.

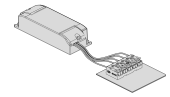

PANZERI

Giano

Accessories / diffusion

XM2033/34/45/46-1200S Écran diffuseur en polycarbonate extrudé avec finition opaline, longueur 12000mm (472,4").

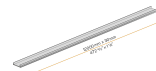

XM2033/34/45/46-1200S PR Écran diffuseur en polycarbonate extrudé microprismatique, longueur 12000mm (472,4").

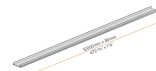

XM2033/34/45/46-600S Écran diffuseur en polycarbonate extrudé avec finition opaline, longueur 6000mm (236,2").

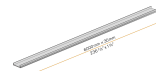

XM2033/34/45/46-600S PR Écran diffuseur en polycarbonate extrudé microprismatique, longueur 6000mm (236,2").

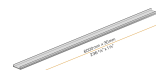

XM2033/34/45/46-900S Écran diffuseur en polycarbonate extrudé avec finition opaline, longueur 9000mm (354,3").

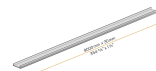

XM2033/34/45/46-900S PR Écran diffuseur en polycarbonate extrudé microprismatique, longueur 9000mm (354,3").

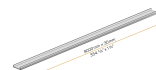

PANZERI

Giano

Accessories / fixation

XM246-01-KIT-S

Paire de kit de suspension, avec câble en acier d'une longueur de 2000mm (78 4/5").

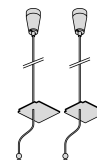
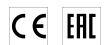

XM246-01-KIT-S1

Kit de suspension individuel pour raccords, avec câble en acier d'une longueur de 2000mm (78 4/5").



PANZERI

Giano

Accessories / jonction

XM246-U

Kit de raccord linéaire.

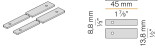

PANZERI

Giano

Accessories / fermeture

XM246-01T

Paire d'embouts.

