

PANZERI

Zero Round

24V DC

M03330.075.0410

● titane



Fiche technique

CODE	M03330.075.0410
CONSUMMATION ÉLECTRIQUE DU SYSTÈME	36W
EFFICACITÉ	84.97lm/W
SOURCE DE LUMIÈRE	LED
DURÉE DE VIE DE LA SOURCE LUMINEUSE	L70 (B50) 60.000h
TEMPÉRATURE DE COULEUR	3000K Ra>90
DISTRIBUTION LUMINEUSE	faisceau diffus
ALIMENTATION ÉLECTRIQUE	24V DC
ALIMENTATION	déporté non inclus
FLUX LUMINEUX NOMINAL	4252lm
FLUX LUMINEUX SORTANT	3059lm
EFFICACITÉ	71.9%
POIDS	1,12 Kg
DEGRÉ DE PROTECTION	IP20
TOLÉRANCE DE COULEUR	SDCM 3
DIMENSIONS DE L'EMBALLAGE	83,0 x 83,0 x 10,0 cm



Suspension d'intérieur pour installations simples ou multiples, avec émission directe et indirecte.

Structure en aluminium extrudé courbé avec peinture polyacrylique blanche, noire, bronze, laiton satiné ou titane.

Écran diffuseur en polycarbonate extrudé avec finition opaline.

Kit de suspension avec ajusteurs rapides et câbles en acier d'une longueur de 5m (196,9").

Cordon d'alimentation en PVC transparent d'une longueur de 5m (196,9").

Fourni sans platine d'alimentation.

Dessin technique



Diagramme polaire



PANZERI

Zero Round

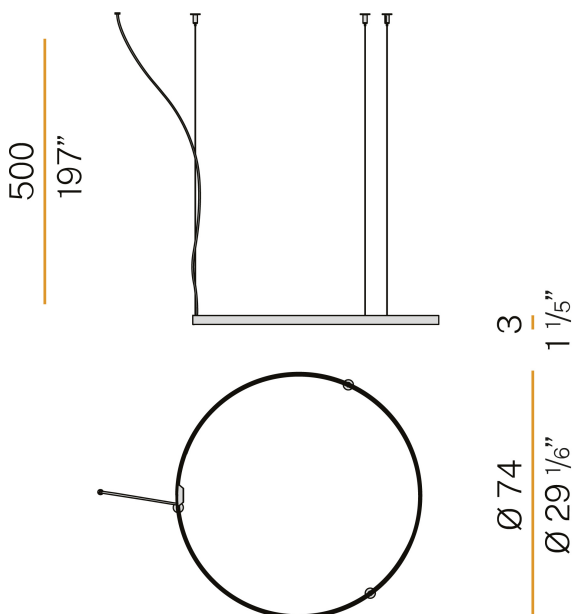
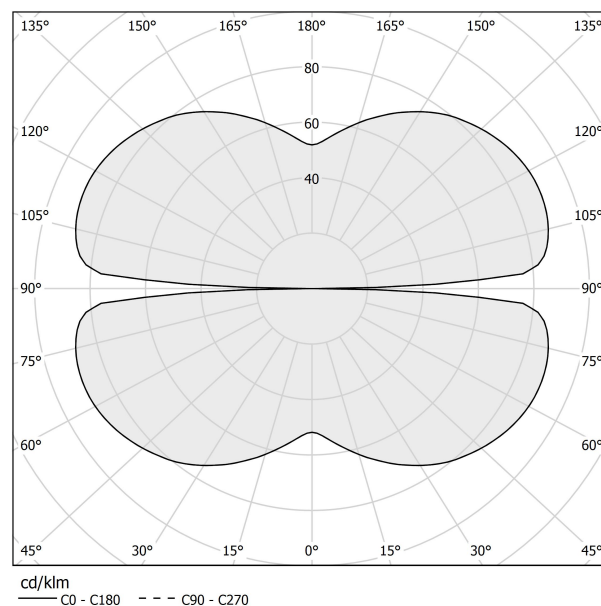
Accessories / alimentation

XM03330.511.0002

Platine pour alimentation de 1 modèle Zero Shapes, avec driver DALI/Push DIM.



4,1
1 7/8"



20,6
8 1/8"

XM03330.522.0002

Platine pour alimentation de 2 modèles Zero Shapes, avec driver DALI/Push DIM.



9,8
1 1/2"



32,5
12 1/4"

XM03330.523.0002

Platine pour alimentation de 3 modèles Zero Shapes, avec driver DALI/Push DIM.



9,8
1 1/2"



32,5
12 1/4"

XM03330.524.0002

Platine pour alimentation de 4 modèles Zero Shapes, avec driver DALI/Push DIM.



9,8
1 1/2"











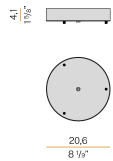



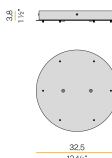

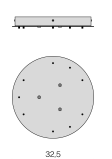



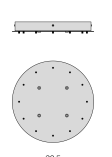

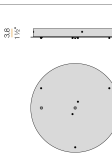

32,5
12 1/4"

PANZERI

Zero Round

Accessories / alimentation et fixation

XM03330.531.0002	Platine pour alimentation et suspension de 1 modèle Zero Shapes Horizontal, avec driver DALI/Push DIM.	
   		
XM03330.532.0002	Platine pour alimentation et suspension de 2 modèles Zero Shapes Horizontal, avec driver DALI/Push DIM.	
   		
XM03330.533.0002	Platine pour alimentation et suspension de 3 modèles Zero Shapes Horizontal, avec driver DALI/Push DIM.	
   		
XM03330.534.0002	Platine pour alimentation et suspension de 4 modèles Zero Shapes Horizontal, avec driver DALI/Push DIM.	
   		
XM03430.552.0002	Platine pour alimentation et suspension de 1 modèle Zero Shapes Horizontal et 1 modèle Zero Round Vertical, avec driver DALI/Push DIM.	
   		
XM03430.553.0002	Platine pour alimentation et suspension de 2 modèles Zero Shapes Horizontal et 1 modèle Zero Round Vertical, avec driver DALI/Push DIM.	
   		
XM03430.554.0002	Platine pour alimentation et suspension de 2 modèles Zero Shapes Horizontal et 2 modèles Zero Round Vertical, avec driver DALI/Push DIM.	