

# PANZERI

## Zero Square

24V DC  
M03230.050.0510

● titane



### Fiche technique

CODE	M03230.050.0510
CONSUMMATION ÉLECTRIQUE DU SYSTÈME	25W
EFFICACITÉ	81.56lm/W
SOURCE DE LUMIÈRE	LED
DURÉE DE VIE DE LA SOURCE LUMINEUSE	L70 (B50) 60.000h
TEMPÉRATURE DE COULEUR	2700K Ra>90
DISTRIBUTION LUMINEUSE	faisceau diffus
ALIMENTATION ÉLECTRIQUE	24V DC
ALIMENTATION	déporté non inclus
FLUX LUMINEUX NOMINAL	2835lm
FLUX LUMINEUX SORTANT	2039lm
EFFICACITÉ	71.9%
POIDS	0,92 Kg
DEGRÉ DE PROTECTION	IP20
TOLÉRANCE DE COULEUR	SDCM 3
DIMENSIONS DE L'EMBALLAGE	58,0 x 58,0 x 10,0 cm



Suspension d'intérieur pour installations simples ou multiples, avec émission directe et indirecte.

Structure en aluminium extrudé courbé avec peinture polyacrylique blanche, noire, bronze, laiton satiné ou titane.

Écran diffuseur en polycarbonate extrudé avec finition opaline.

Kit de suspension avec ajusteurs rapides et câbles en acier d'une longueur de 5m (196,9").

Cordon d'alimentation en PVC transparent d'une longueur de 5m (196,9").

Fourni sans platine d'alimentation.

### Dessin technique

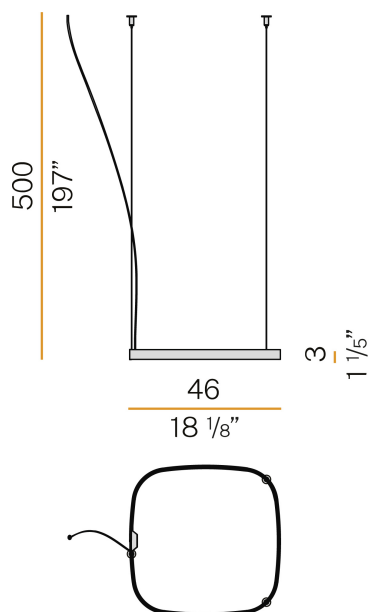

### Diagramme polaire

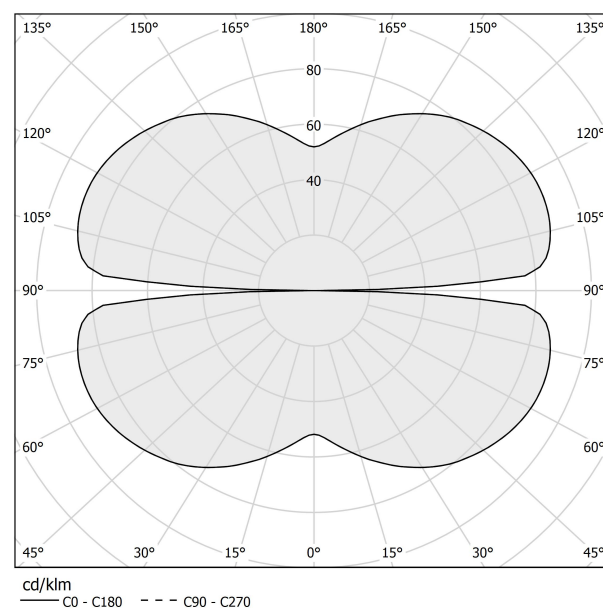

# PANZERI

## Zero Square

### Accessories / alimentation

XM03330.511.0002

Platine pour alimentation de 1 modèle Zero Shapes, avec driver DALI/Push DIM.



20.6  
8 1/8"

XM03330.522.0002

Platine pour alimentation de 2 modèles Zero Shapes, avec driver DALI/Push DIM.



32.5  
12 5/8"

XM03330.523.0002

Platine pour alimentation de 3 modèles Zero Shapes, avec driver DALI/Push DIM.



32.5  
12 5/8"

XM03330.524.0002

Platine pour alimentation de 4 modèles Zero Shapes, avec driver DALI/Push DIM.









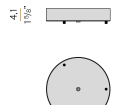

32.5  
12 5/8"

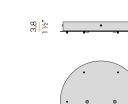
# PANZERI

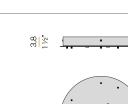
## Zero Square

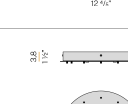
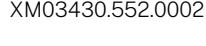
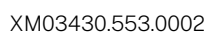
### Accessories / alimentation et fixation

XM03330.531.0002 	Platine pour alimentation et suspension de 1 modèle Zero Shapes Horizontal, avec driver DALI/Push DIM.	
XM03330.532.0002 	Platine pour alimentation et suspension de 2 modèles Zero Shapes Horizontal, avec driver DALI/Push DIM.	
XM03330.533.0002 	Platine pour alimentation et suspension de 3 modèles Zero Shapes Horizontal, avec driver DALI/Push DIM.	
XM03330.534.0002 	Platine pour alimentation et suspension de 4 modèles Zero Shapes Horizontal, avec driver DALI/Push DIM.	
XM03430.552.0002 	Platine pour alimentation et suspension de 1 modèle Zero Shapes Horizontal et 1 modèle Zero Round Vertical, avec driver DALI/Push DIM.	
XM03430.553.0002 	Platine pour alimentation et suspension de 2 modèles Zero Shapes Horizontal et 1 modèle Zero Round Vertical, avec driver DALI/Push DIM.	
XM03430.554.0002 	Platine pour alimentation et suspension de 2 modèles Zero Shapes Horizontal et 2 modèles Zero Round Vertical, avec driver DALI/Push DIM.	