

# PANZERI

## Astoria Spot

48V DC dimmable (DALI)

B43002.030.1719



noir



### Fiche technique

CODE	B43002.030.1719
CONSOmmATION éLECTRIQUE DU SYSTèME	5,7W
EFFICACITé	82.8lm/W
SOURCE DE LUMIèRE	LED
TEMPéRATURE DE COULEUR	2700K Ra>90
DISTRIBUTION LUMINEUSE	faisceau moyen
ANGLE DE FAISCEAU	30°
ALIMENTATION éLECTRIQUE	48V DC
CONFIGURATION éLECTRIQUE	dimmable (DALI)
ALIMENTATION	déporté non inclus
FLUX LUMINEUX SORTANT	414lm
POIDS	0,22 Kg
DEGRé DE PROTECTION	IP20
DIMENSIONS DE L'EMBALLAGE	0,0 x 0,0 x 0,0 cm



Module d'éclairage linéaire pour rail électrifié très basse tension 48V pour applications au plafond/mur, en suspension et encastrées, disponible en deux longueurs différentes. Corps en aluminium noir, optiques en polycarbonate avec un angle de rayonnement de 30° et couvercle en plastique. Disponible en 2700K et 3000K. Possibilité de gradation via le protocole DALI.

### Dessin technique

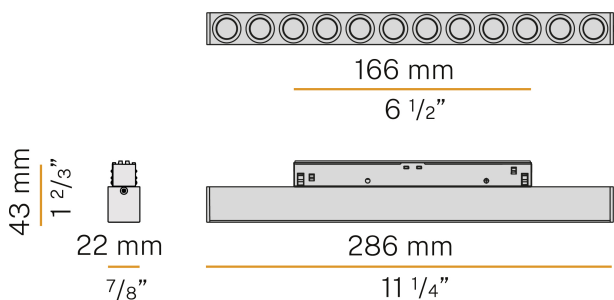

### Application



### Diagramme polaire

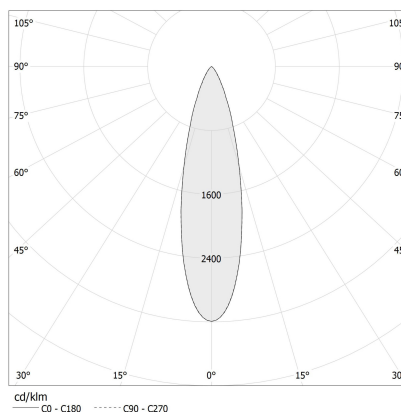

# PANZERI

## Astoria Spot

### Accessories / rails conducteurs

9500-2/B-ST2-E

Rail électrifié DALI 48V DC pour suspension ou montage au plafond, longueur 2000mm (78.7").

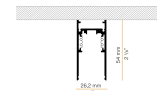

9500-2/B-ST5-E

Rail électrifié encastré 48V DC DALI, longueur 2000mm (78.7").

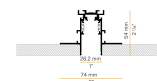

# PANZERI

## Astoria Spot

### Accessories / rails conducteurs / alimentation

9500/P-100E-B-C1-N

Kit d'alimentation avec platine pour rail électrifié monté au plafond, avec driver 100W/48V et tête d'alimentation. Longueur du câble 200mm (7.87").

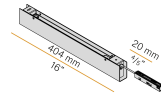

9500/P-100E-B-SP-N

Kit d'alimentation avec platine pour rail suspendu électrifié, avec driver 100W/48V et tête d'alimentation. Longueur du câble 2000mm (78.7").

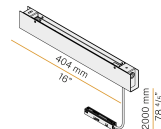

YBE41002.DV1

Alimentation intégrée pour 48V DC, 100W, DALI.



YDV.048.075.A01

Alimentation LED, 75W 48V DC, on/off.

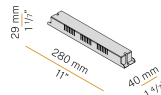

YDV.048.150.A01

Alimentation LED, 150W 24V DC, on/off.

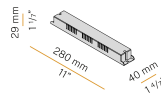

# PANZERI

## Astoria Spot

### Accessories / rails conducteurs / alimentation et fermeture

---

9501-S/B-E

Alimentation DALI 48V DC pour rail électrifié.

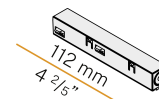

# PANZERI

## Astoria Spot

### Accessories / rails conducteurs / fermeture

9504/ST2-B

Embout pour rail électrifié 48V DC, sans trou.

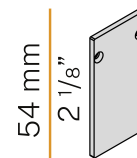

9504/ST2-B-F

Embout pour rail électrifié 48V DC, avec trou.

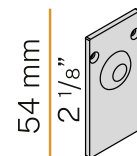

S-9500-L/B-2000

Cache de protection pour l'installation de rails électrifiés encastrés. Longueur 2000mm (78.7").

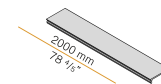

S-9500/LE-B-3000

Cache esthétique d'une longueur de 3000mm (118.1") pour les rails électrifiés en 48V DC.

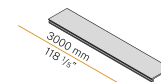

# PANZERI

## Astoria Spot

### Accessories / rails conducteurs / fixation

9500-KIT1-3

Kit de suspension d'extrémité, avec câble en acier d'une longueur de 3000mm (118.1"), pour rail électrifié.

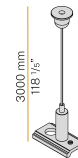

S-9000-P4

Kit de suspension pour rail encastré avec tige rigide longueur 1000mm (39.4").

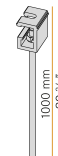

S-9000/118

Clip de fixation rapide avec tendeur pour tige rigide de suspension.

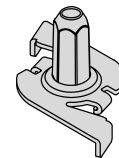

S-9500/114-B

Kit de fixation au plafond pour rail électrifié 48V DC.

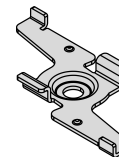

# PANZERI

## Astoria Spot

### Accessories / rails conducteurs / jonction

9503-S/B-E

Raccord linéaire électrifié pour rail DALI 48V DC.

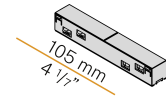

9511/B-E

Raccord électrifié en forme de L pour rail DALI 48V DC.

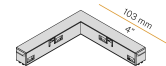

9518-S/B-E

Raccord électrifié flexible pour rail DALI 48V DC.



S-9500/314-B

Raccord linéaire sans contact pour rail électrifié encastré 48V DC.

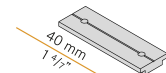

S-9500/323-SV

Raccord linéaire sans contact pour rail électrifié encastré 48V DC.

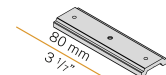

S-9511-I/B-ST5

Raccord mécanique en "L" pour rail électrifié 48V DC sans bordure, mur/plafond intérieur.

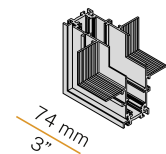

S-9511/B-ST2

Raccord linéaire pour rail électrifié suspendu ou monté au plafond.

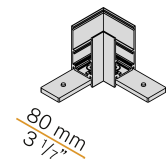

S-9511/B-ST5

Raccord mécanique en "L" pour rail électrifié 48V DC sans bordure.

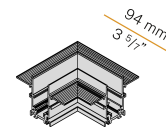

### Accessories / rails conducteurs / fixation et jonction

---

9500-KIT2-3

Kit de fixation et de jonction pour rail suspendu électrifié, avec câble en acier d'une longueur de 3000mm (118.1").

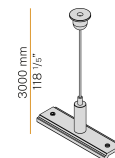



# PANZERI

## Astoria Spot

### Accessories / rails conducteurs / contrôle du signal

YRS.B048.A16

Dispositif de répétition pour l'opto-isolation du data bus pour rail électrifié DALI 48V DC.

