

PANZERI

Queens 10

220-240V AC ON-OFF
XM748-12-01-3K

● white



Data sheet

CODE	XM748-12-01-3K
SYSTEM POWER CONSUMPTION	12W
EFFICACY	101.75lm/W
LIGHT SOURCE	LED
LIGHT SOURCE LIFETIME	L80 (B10) 50.000h
COLOUR TEMPERATURE	3000K Ra>90
LIGHT DISTRIBUTION	adjustable
BEAM ANGLE	30°
POWER SUPPLY	220-240V AC
FREQUENCY	50/60Hz
ELECTRICAL CONFIGURATION	ON-OFF
DRIVER	integrated included
NOMINAL LUMINOUS FLUX	1469lm
LUMEN OUTPUT	1221lm
EFFICIENCY	83.1%
GLARE RATING	UGR < 11
WEIGHT	0.50 Kg
PROTECTION DEGREE	IP20
GLOW WIRE TEST PERFORMANCE	850°
PACKING DIMENSIONS	12,0 x 30,0 x 11,5 cm



Lighting fixture for electrified track for interiors, with swivelling light beam.
Die-cast aluminium joint with powder paint.
Die-cast aluminium cap with powder paint.
Die-cast aluminium structure rotating on two axes in white or black powder paint.
Reflector in thermoplastic material with chrome plated finish.
Equipped with electric and mechanical adapter for three-phase electrified tracks.



Technical drawing

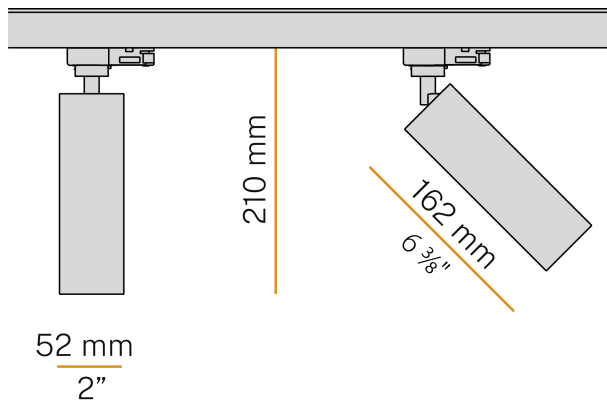

Application



Polar diagram

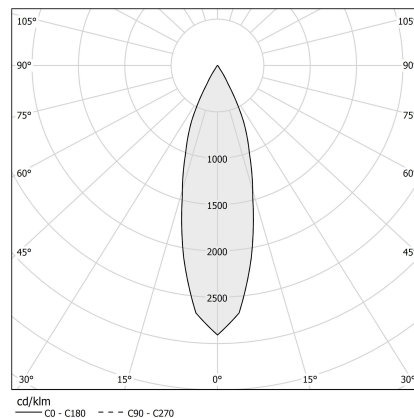

PANZERI

Queens 10

Accessories / diffusion

XMR5

Spot optic.

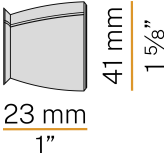

XMR7

Wide flood optic.

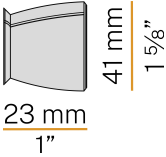

PANZERI

Queens 10

Accessories / electrified tracks

XM7501-100



Three-phase electrified track for suspended or ceiling installation for interiors. Structure in anodized extruded aluminium or with white or black powder paint. Copper conductors housed inside extruded section bars in PVC with high isolation resistance. 230-250V AC line voltage or 380-440V AC industrial line voltage power supply. 16A total electrical load. Fastening, joining and closing accessories to be ordered separately. Length: 1m (39,4")

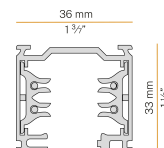

XM7501-200



Three-phase electrified track for suspended or ceiling installation for interiors. Structure in anodized extruded aluminium or with white or black powder paint. Copper conductors housed inside extruded section bars in PVC with high isolation resistance. 230-250V AC line voltage or 380-440V AC industrial line voltage power supply. 16A total electrical load. Fastening, joining and closing accessories to be ordered separately. Length: 2m (78,7")

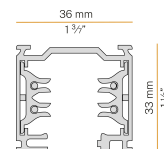

XM7501-300



Three-phase electrified track for suspended or ceiling installation for interiors. Structure in anodized extruded aluminium or with white or black powder paint. Copper conductors housed inside extruded section bars in PVC with high isolation resistance. 230-250V AC line voltage or 380-440V AC industrial line voltage power supply. 16A total electrical load. Fastening, joining and closing accessories to be ordered separately. Length: 3m (118,1")

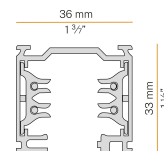

PANZERI

Queens 10

Accessories / electrified tracks / adapters

XM7501

Electro/mechanical adapter 6A, mechanical load 5kg, for three-phase electrified track.



XM76B01

Mechanical adapter with automatic locking for three-phase electrified track.

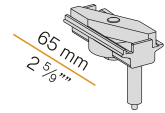

PANZERI

Queens 10

Accessories / electrified tracks / power supply and closing

XM76ADX01

Right live-end for three-phase electrified track.

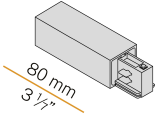

XM76ASX01

Left live-end for three-phase electrified track.

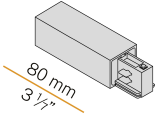

PANZERI

Queens 10

Accessories / electrified tracks / power supply and junction

XM76A01

Central connector and straight joint for three-phase electrified track.

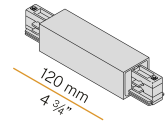

PANZERI

Queens 10

Accessories / electrified tracks / closing

XM76C01

Cover 1000mm (39,4") long for three-phase electrified track.

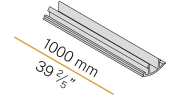

XM76E01

End cap for three-phase electrified track.

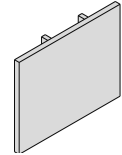

PANZERI

Queens 10

Accessories / electrified tracks / fixing

XM76K

Ceiling kit for three-phase electrified track.

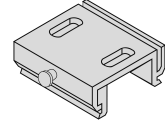

XM76S01

Suspension kit with 2m (78,7") long steel wire and plate for three-phase electrified track.

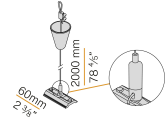

PANZERI

Queens 10

Accessories / electrified tracks / junction

XM76F01

Flexible joint for three-phase electrified track.

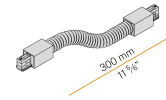

XM76LE01

External "L" joint for three-phase electrified track.



XM76LI01

Internal "L" joint for three-phase electrified track.

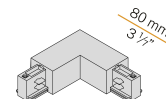

XM76M01

Mobile joint for three-phase electrified track.

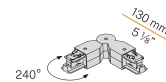

XM76Q01

Electrical straight joint with stop for three-phase electrified track.

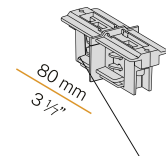

XM76TDX01

Right "T" joint for three-phase electrified track.

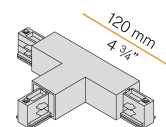

XM76TSX01

Left "T" joint for three-phase electrified track.

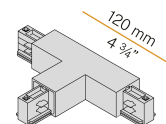

XM76U01

Mechanical straight joint for three-phase electrified track.

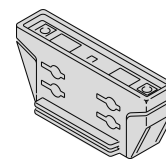

XM76X01

"X" joint for three-phase electrified track.

