

# PANZERI

## Brooklyn

24V DC  
XG2033-100TRACK

 white/opal screen



### Data sheet

CODE	XG2033-100TRACK
SYSTEM POWER CONSUMPTION	max 24W/m
LIGHT SOURCE	LED
LIGHT DISTRIBUTION	diffused
POWER SUPPLY	24V DC
DRIVER	remote not included
WEIGHT	0,83 Kg
PROTECTION DEGREE	IP40 IP20
SHOCK RESISTANCE RATING	IK08
GLOW WIRE TEST PERFORMANCE	850°
PACKING DIMENSIONS	6,0 x 6,0 x 114,0 cm
L (mm)	1010
L (in)	39 4/5"
ADVISED BRACKETS	2
HOLE (mm)	1015 x 40
HOLE (in)	40" x 1 3/8"



Modular profile for ceiling or wall built-in installation for interiors, with direct light emission.  
Total built-in structure in plasterboard, in extruded aluminium in RAL 9003 white powder paint.  
Extruded polycarbonate diffuser with opaline finish.  
Equipped with disposal screen for smoothing, plastering and painting of the installation surface.  
Light modules and driver to be ordered separately.  
Fastening, joining and closing accessories to be ordered separately.  
Built-in hole dimension: 1015x40mm (40x1,6")

### Technical drawing

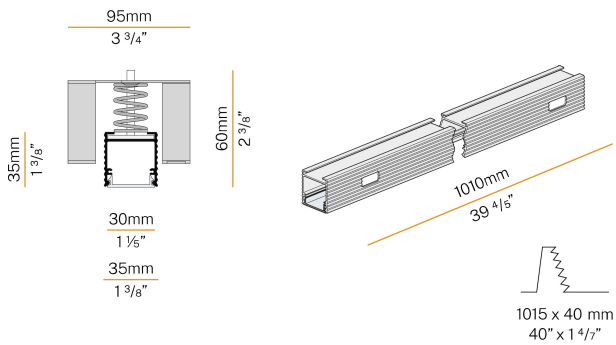

### Application



### Polar diagram

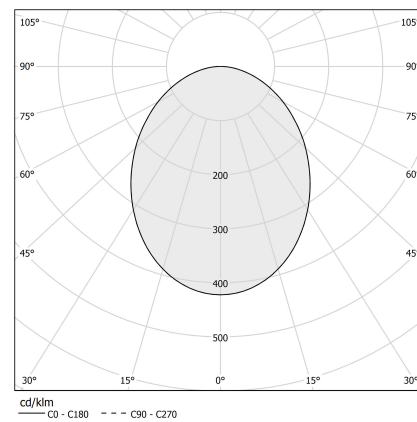

# PANZERI

## Brooklyn

### Accessories / source

XM006.012.0410 LED module, 125mm (5") 16 LED 2,2W 24V DC 3000K Ra>90 285lm.



XM006.050.0410 LED module, 500mm (19,7") 64 LED 8,6W 24V DC 3000K Ra>90 1140lm.



YLR001.022.0110 Strip LED, 5000mm (196,9") 160 LED/m 21,6W/m 24V DC 3000K Ra>80 3020lm/m, to be cut each 50mm (2").



YLR002.017.0410 Strip LED, 5000mm (196,9") 168 LED/m 17,3W/m 24V DC 3000K Ra>90 1810lm/m, to be cut each 42mm (1,7").



YLR002.017.0610 Strip LED, 5000mm (196,9") 168 LED/m 17,3W/m 24V DC 4000K Ra>90 1920lm/m, to be cut each 42mm (1,7").



YLR003.010.0410 Strip LED, 5000mm (196,9") 168 LED/m 9,6W/m 24V DC 3000K Ra>90 930lm/m, to be cut each 42mm (1,7").



YLR003.010.0510 Strip LED, 5000mm (196,9") 168 LED/m 9,6W/m 24V DC 2700K Ra>90 882lm/m, to be cut each 42mm (1,7").



YLR003.010.0610 Strip LED, 5000mm (196,9") 168 LED/m 9,6W/m 24V DC 4000K Ra>90 980lm/m, to be cut each 42mm (1,7").



# PANZERI

## Brooklyn

### Accessories / power supply

XM100/24 DIM

LED driver, 100W 24V DC, DALI/Push DIM dimmable.

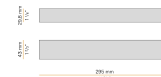

XM150/24 DIM

LED driver, 150W 24V DC, DALI/Push DIM dimmable.



XM18/24 DIM

LED driver, 18W 24V DC, DALI/Push DIM dimmable.

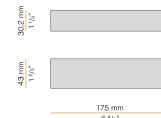

XM35/24 DIM

LED driver, 35W 24V DC, DALI/Push DIM dimmable.

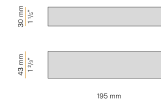

XM6-20 UNI

LED driver, 4x20W 250=700mA.

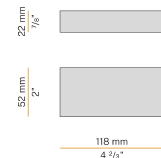

XM60/24 DIM

LED driver, 60W 24V DC, DALI/Push DIM dimmable.

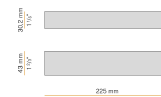

YDV.024.030.A01

LED driver, 30W 24V DC.



YDV.024.120.A01

LED driver, 120W 24V DC.

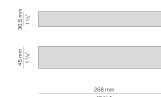

YDV.024.180.A01

LED driver, 180W 24V DC.



# PANZERI

Brooklyn

## Accessories / connection

---

XM2033/34/32/31-S

Power cables.



# PANZERI

## Brooklyn

### Accessories / diffusion

XM2033/34-WHI

White reflector with 1000mm (39,4") length to be cut.



XM2033/34/45/46-1200S

Extruded polycarbonate diffuser with opaline finish, 12000mm (472,4") long.

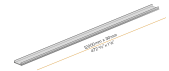

XM2033/34/45/46-600S

Extruded polycarbonate diffuser with opaline finish, 6000mm (236,2") long.

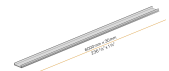

XM2033/34/45/46-900S

Extruded polycarbonate diffuser with opaline finish, 9000mm (354,3") long.

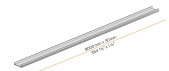

# PANZERI

## Brooklyn

### Accessories / fixing

XM2033-F

Drywall fixing bracket for trimless recessed profiles.

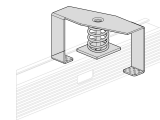

XM2033/34-L

Pair of fixing plates for recessed installation in brick wall or concrete.



XM2033/34/38/39P

Plate for hanging.

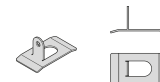

# PANZERI

## Brooklyn

### Accessories / junction

XM2033-U45

Two profiles level junction with 45° cut, for total built-in installation.

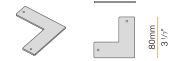

XM2033-U90

Connection joint for two lines of modular profiles with level junction 90°, for total built-in installation.

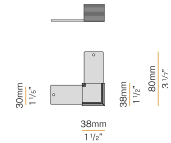

XM2033-UT

Three profiles "T" level junction, for total built-in installation.



XM2033-X

Four profiles "X" level junction, for total built-in installation.



XM2033/34-ANG

Two profiles perpendicular junction with 45° cut.

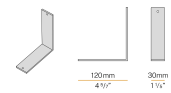

XM2033/34-U

Linear junction.

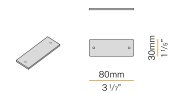

# PANZERI

## Brooklyn

### Accessories / closing

---

XM2033-T

Pair of end caps with screws for trimless recessed profiles.

