

PANZERI

Brooklyn Round

220-240V AC dimmable (DALI/Push DIM)

P23101.180.0402

● white



Data sheet

CODE	P23101.180.0402
SYSTEM POWER CONSUMPTION	29W
EFFICACY	51.14lm/W
LIGHT SOURCE	LED
LIGHT SOURCE LIFETIME	L80 (B20) 80.000h
COLOUR TEMPERATURE	3000K Ra>90
LIGHT DISTRIBUTION	diffused
POWER SUPPLY	220-240V AC
FREQUENCY	50/60Hz
ELECTRICAL CONFIGURATION	dimmable (DALI/Push DIM)
DRIVER	integrated included
NOMINAL LUMINOUS FLUX	3420lm
LUMEN OUTPUT	1483lm
EFFICIENCY	43.4%
WEIGHT	1,99 Kg
PROTECTION DEGREE	IP40
COLOUR TOLLERANCES	SDCM 3
GLOW WIRE TEST PERFORMANCE	850°
PACKING DIMENSIONS	13,0 x 108,0 x 57,0 cm



Ceiling or wall lighting fixture for interiors, with direct light emission.
Banded extruded aluminium structure in white, black or mat brass polyacrylic paint.
Extruded polycarbonate diffuser with opaline finish.
Galvanized sheet metal end caps in polyacrylic paint.
Turned brass ceiling-fastening spacers in polyacrylic paint.



Technical drawing

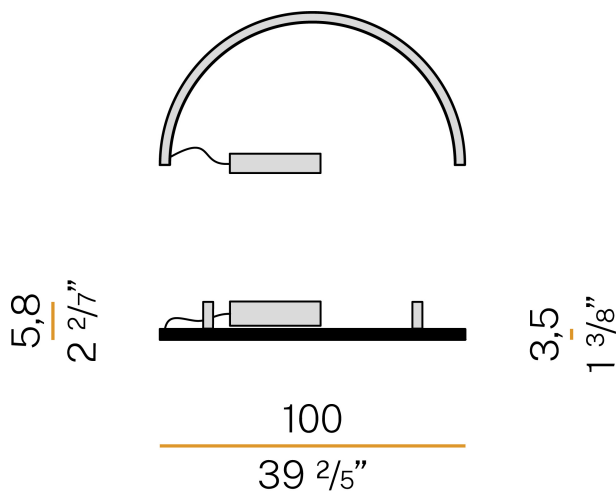

Application



Polar diagram

