

# PANZERI

## Lola

220-240V AC dimmable (phase cut)

P12030.020.2504

titanium



### Data sheet

CODE	P12030.020.2504
SYSTEM POWER CONSUMPTION	9W
EFFICACY	108lm/W
LIGHT SOURCE	LED
LIGHT SOURCE LIFETIME	L80 (B10) 50.000h
COLOUR TEMPERATURE	3000K Ra>90
LIGHT DISTRIBUTION	adjustable
BEAM ANGLE	24°
POWER SUPPLY	220-240V AC
FREQUENCY	50/60Hz
ELECTRICAL CONFIGURATION	dimmable (phase cut)
DRIVER	integrated included
NOMINAL LUMINOUS FLUX	1170lm
LUMEN OUTPUT	972lm
EFFICIENCY	83.1%
GLARE RATING	UGR < 11
WEIGHT	0.60 Kg
PROTECTION DEGREE	IP20
GLOW WIRE TEST PERFORMANCE	850°
PACKING DIMENSIONS	12,0 x 29,5 x 11,0 cm



Ceiling or wall lighting fixture for interiors, with swivelling light beam.  
Ceiling/wall plate in die-cast aluminium with polyacrylic paint.  
Electrical connection housing in die-cast aluminium with polyacrylic paint.  
Die-cast aluminium joint with polyacrylic paint.  
Die-cast aluminium structure rotating on two axes in white, black, bronze, mat brass or titanium polyacrylic paint.  
Reflector in thermoplastic material with chrome plated finish.



### Technical drawing

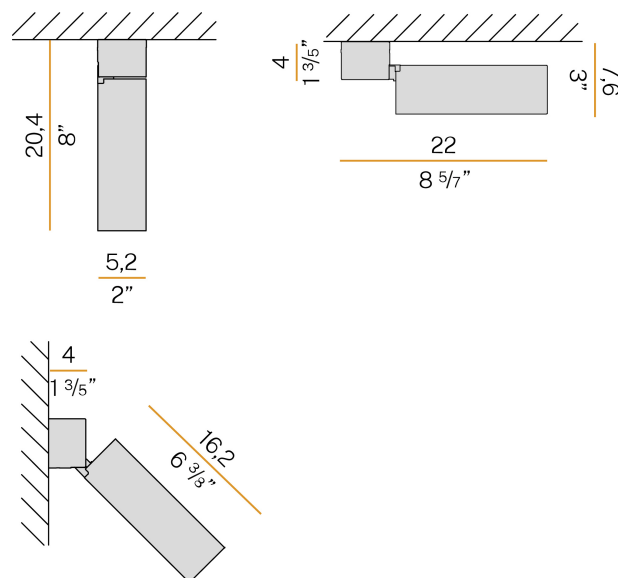

### Application



### Polar diagram

