

PANZERI

Gong

220-240V AC dimmable (DALI/Push DIM)

L09302.060.0402



Data sheet

CODE	L09302.060.0402
SYSTEM POWER CONSUMPTION	43W
EFFICACY	102.63lm/W
LIGHT SOURCE	LED
LIGHT SOURCE LIFETIME	L90 (B10) 50.000h
COLOUR TEMPERATURE	3000K Ra>90
LIGHT DISTRIBUTION	diffused
POWER SUPPLY	220-240V AC
FREQUENCY	50/60Hz
ELECTRICAL CONFIGURATION	dimmable (DALI/Push DIM)
DRIVER	integrated included
NOMINAL LUMINOUS FLUX	5564lm
LUMEN OUTPUT	4413lm
EFFICIENCY	79.3%
WEIGHT	3,46 Kg
PROTECTION DEGREE	IP20
COLOUR TOLLERANCES	SDCM 3
PACKING DIMENSIONS	17,0 x 69,0 x 69,0 cm

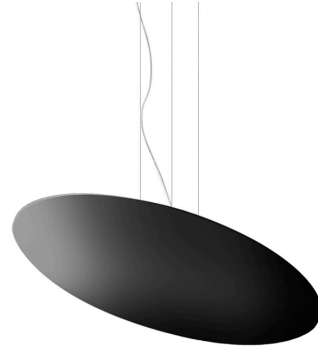

Suspension lighting fixture for interiors, with indirect light emission. Aluminium and pickled sheet metal structure in polyacrylic paint. Turned aluminium reflector in white or black polyacrylic paint or with gold leaf coating. Moulded acrylic diffuser with mat finish. 2m (78,7") long steel suspension cables. 2,2m (86,6") long power cable in transparent PVC. Power canopy with pickled sheet metal case in white or black polyacrylic paint or with gold leaf coating.

Technical drawing

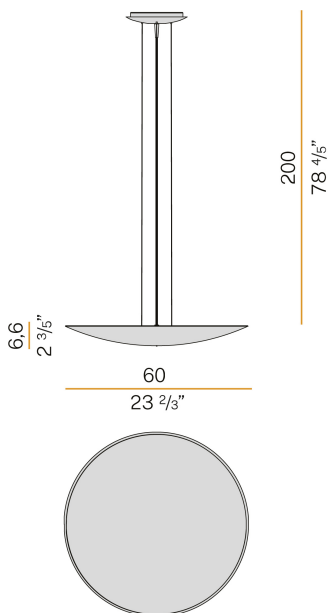

Polar diagram

