

PANZERI

Queens 20

220-240V AC ON-OFF
B76002.026.2501

● black



Data sheet

CODE	B76002.026.2501
SYSTEM POWER CONSUMPTION	26W
EFFICACY	72.69lm/W
LIGHT SOURCE	LED
LIGHT SOURCE LIFETIME	L80 (B10) 50.000h
COLOUR TEMPERATURE	3000K Ra>90
LIGHT DISTRIBUTION	adjustable
BEAM ANGLE	30°
POWER SUPPLY	220-240V AC
FREQUENCY	50/60Hz
ELECTRICAL CONFIGURATION	ON-OFF
DRIVER	integrated included
NOMINAL LUMINOUS FLUX	2700lm
LUMEN OUTPUT	1890lm
EFFICIENCY	70%
WEIGHT	0,40 Kg
PROTECTION DEGREE	IP20
GLOW WIRE TEST PERFORMANCE	850°
PACKING DIMENSIONS	17,5 x 29,8 x 7,9 cm



Lighting fixture for electrified track for interiors, with swivelling light beam.
Die-cast aluminium joint with powder paint.
Die-cast aluminium structure rotating on two axes in white or black powder paint.
Reflector in thermoplastic material with chrome plated finish.
Anti-glare snoot in black thermoplastic material.
Equipped with electric and mechanical adapter for three-phase electrified tracks.



Technical drawing

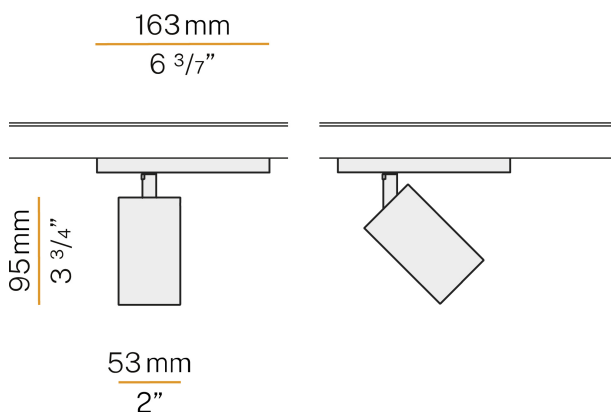

Application



Polar diagram

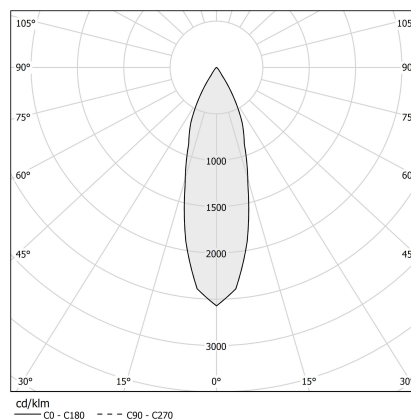

PANZERI

Queens 20

Accessories / diffusion

XMR5

Spot optic.

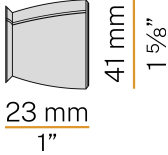

XMR7

Wide flood optic.

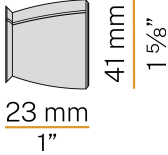

PANZERI

Queens 20

Accessories / electrified tracks

XM7502-100



Three-phase electrified track for suspended or ceiling installation for interiors. Structure in anodized extruded aluminium or with white or black powder paint. Copper conductors housed inside extruded section bars in PVC with high isolation resistance. 230-250V AC line voltage or 380-440V AC industrial line voltage power supply. 16A total electrical load. Fastening, joining and closing accessories to be ordered separately. Length: 1m (39,4")

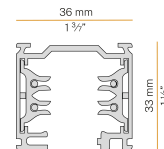

XM7502-200



Three-phase electrified track for suspended or ceiling installation for interiors. Structure in anodized extruded aluminium or with white or black powder paint. Copper conductors housed inside extruded section bars in PVC with high isolation resistance. 230-250V AC line voltage or 380-440V AC industrial line voltage power supply. 16A total electrical load. Fastening, joining and closing accessories to be ordered separately. Length: 2m (78,7")

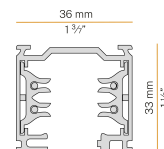

XM7502-300



Three-phase electrified track for suspended or ceiling installation for interiors. Structure in anodized extruded aluminium or with white or black powder paint. Copper conductors housed inside extruded section bars in PVC with high isolation resistance. 230-250V AC line voltage or 380-440V AC industrial line voltage power supply. 16A total electrical load. Fastening, joining and closing accessories to be ordered separately. Length: 3m (118,1")

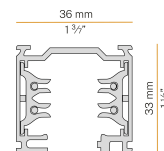

PANZERI

Queens 20

Accessories / electrified tracks / adapters

XM7502

Electro/mechanical adapter 6A, mechanical load 5kg, for three-phase electrified track.



XM76B02

Mechanical adapter with automatic locking for three-phase electrified track.

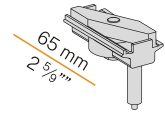

PANZERI

Queens 20

Accessories / electrified tracks / power supply and closing

XM76ADX02

Right live-end for three-phase electrified track.

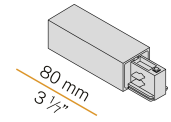

XM76ASX02

Left live-end for three-phase electrified track.

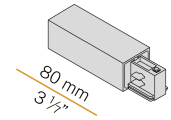

PANZERI

Queens 20

Accessories / electrified tracks / power supply and junction

XM76A02

Central connector and straight joint for three-phase electrified track.

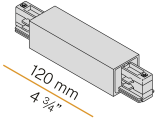

PANZERI

Queens 20

Accessories / electrified tracks / closing

XM76C02

Cover 1000mm (39,4") long for three-phase electrified track.

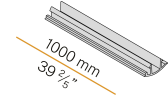

XM76E02

End cap for three-phase electrified track.

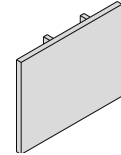

PANZERI

Queens 20

Accessories / electrified tracks / fixing

XM76K

Ceiling kit for three-phase electrified track.

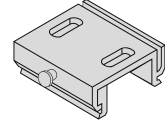

XM76S02

Suspension kit with 2m (78,7") long steel wire and plate for three-phase electrified track.

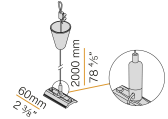

PANZERI

Queens 20

Accessories / electrified tracks / junction

XM76F02

Flexible joint for three-phase electrified track.

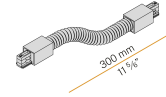

XM76LE02

External "L" joint for three-phase electrified track.



XM76LI02

Internal "L" joint for three-phase electrified track.

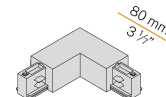

XM76M02

Mobile joint for three-phase electrified track.

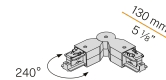

XM76Q02

Electrical straight joint with stop for three-phase electrified track.

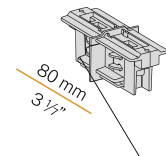

XM76TDX02

Right "T" joint for three-phase electrified track.

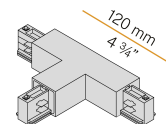

XM76TSX02

Left "T" joint for three-phase electrified track.

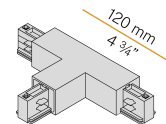

XM76U02

Mechanical straight joint for three-phase electrified track.

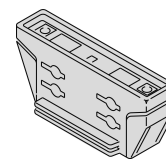

XM76X02

"X" joint for three-phase electrified track.

