

# PANZERI

## Astoria 8

48V DC dimmable (DALI)

B43417.008.2519



### Data sheet

CODE	B43417.008.2519
SYSTEM POWER CONSUMPTION	15W
EFFICACY	73.33lm/W
LIGHT SOURCE	LED
COLOUR TEMPERATURE	3000K Ra>90
LIGHT DISTRIBUTION	adjustable
BEAM ANGLE	24°
POWER SUPPLY	48V DC
ELECTRICAL CONFIGURATION	dimmable (DALI)
DRIVER	remote not included
NOMINAL LUMINOUS FLUX	1090lm
LUMEN OUTPUT	1100lm
EFFICIENCY	100.9%
WEIGHT	0,00 Kg
PROTECTION DEGREE	IP20
PACKING DIMENSIONS	0,0 x 0,0 x 0,0 cm

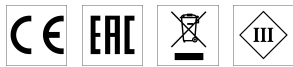

Lighting fixture for electrified track for interiors, with swivelling light beam.

Die-cast aluminium joint and double-axes rotating structure.

Thermoplastic anti-glare snoot and medium-beam lens.

Equipped with electric and mechanical adapter for 48V low voltage electrified tracks.

Available in 2700K and 3000K version, in white, black, mat brass, bronze and titanium finishes, with with black arm and back cover.

### Technical drawing

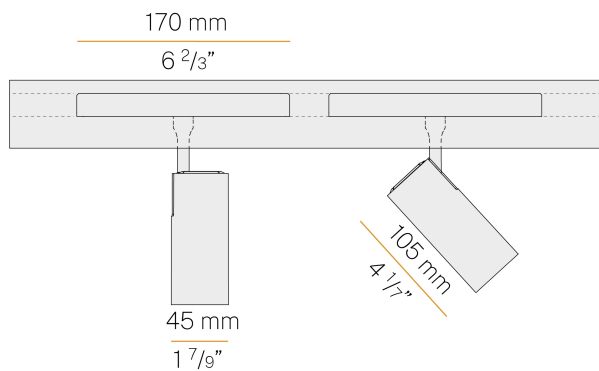

# PANZERI

## Astoria 8

### Accessories / diffusion

---

YLN43400.15



---

YLN43400.35



# PANZERI

## Astoria 8

### Accessories / electrified tracks

---

9500-2/B-ST2-E

Suspended or ceiling-mounted 48V DC DALI electrified track, 2000mm (78,7") long.

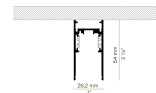

# PANZERI

## Astoria 8

### Accessories / electrified tracks / power supply

9500/P-100E-B-C1-N

Power supply kit with canopy for ceiling-mounted electrified track, with 100W/48V driver and power supply head with 200mm (7.87") long cable.

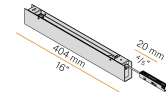

9500/P-100E-B-SP-N

Power supply kit with canopy for electrified suspended track, with 100W/48V driver and power supply head with 2000mm (78.7") long cable.

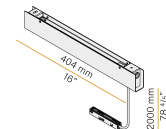

YBE41002.DV1

Integrated 100W on/off power supply for electrified 48V track, with 2 additional cables for DALI feed-through wiring.

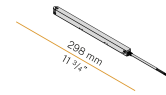

YDV.048.075.A01

LED driver, 75W 48V DC, on/off.

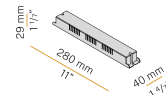

YDV.048.150.A01

LED driver, 150W 48V DC, on/off.

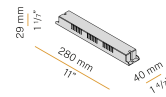

# PANZERI

## Astoria 8

### Accessories / electrified tracks / power supply and closing

9501-S/B-E

Head power supply for 48V DC DALI electrified track.

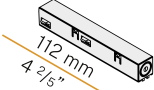

# PANZERI

## Astoria 8

### Accessories / electrified tracks / closing

9504/ST2-B

End cap for 48V DC electrified track, without power supply hole.

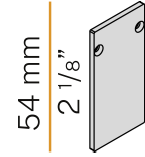

9504/ST2-B-F

End cap for 48V DC electrified track, with power supply hole.

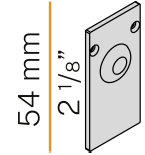

S-9500-L/B-2000

Protective cover for recessed electrified track installation. Length 2000mm (78.7").

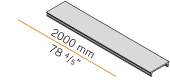

S-9500/LE-B-3000

Aesthetic cover for 48V DC electrified track, length 3000mm (118.1").

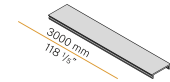

# PANZERI

## Astoria 8

### Accessories / electrified tracks / fixing

9500-KIT1-3

End suspension kit, with 3000mm (118.1") long steel wire, for electrified track.

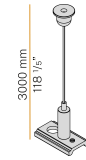

S-9000-P4

Suspension kit with rigid tige 1000mm (39,4") long for recessed track.



S-9000/118

Clip for quick fastening with turnbuckle for rigid suspension tige.

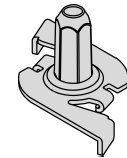

S-9500/114-B

Ceiling mounting kit for 48V DC electrified track.

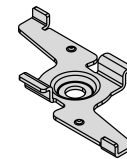

# PANZERI

## Astoria 8

### Accessories / electrified tracks / junction

9503-S/B-E

Linear electrified joint for 48V DC DALI track.

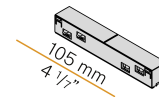

9511/B-E

Electrified "L" joint for 48V DC DALI track.

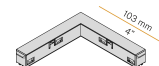

9518-S/B-E

Flexible electrified joint for 48V DC DALI track.



S-9500/314-B

Linear mechanical junction for recessed electrified 48V DC track.

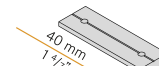

S-9511-I/B-ST5

Internal wall/ceiling "L" joint for 48V DC recessed trimless electrified track.

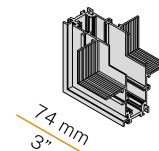

S-9511/B-ST2

"L" junction for 48V DC suspended or ceiling-mounted electrified track.

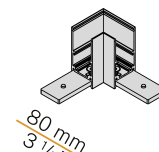

S-9511/B-ST5

Mechanical "L" joint for 48V DC recessed trimless electrified track.

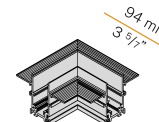

# PANZERI

## Astoria 8

### Accessories / electrified tracks / fixing and junction

---

9500-KIT2-3

Fixing and junction kit, with 3000mm (118.1") long steel wire, for suspended electrified track.

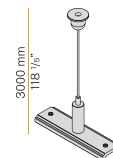

# PANZERI

## Astoria 8

### Accessories / binari elettrificati / signal control

YRS.B048.A16

Repeater device for opto-isolating the data bus, for 48V DC DALI electrified track.

