

PANZERI

Zero Square

24V DC

M03202.075.0410

● Schwarz



Technisches Datenblatt

ARTIKELCODE	M03202.075.0410
LEISTUNGS-AUFNAHME DES SYSTEMS	36W
LICHTAUSBEUTE	84.97lm/W
LICHTQUELLE	LED
LEBENSDAUER DER LICHTQUELLE	L70 (B50) 60.000h
LICHTFARBTEMPERATUR	3000K Ra>90
LICHTVERTEILUNG	Streulichtstrahl
STROMVERSORGUNG	24V DC
TREIBER	externer Treiber nicht enthalten
NENNLICHTSTROM	4252lm
NUTZLICHTSTROM	3059lm
EFFIZIENZ	71.9%
GEWICHT	1,21 Kg
SCHUTZART	IP20
FARBTOLERANZ	SDCM 3
VERPACKUNGSABMESSUNGEN	83,0 x 83,0 x 10,0 cm

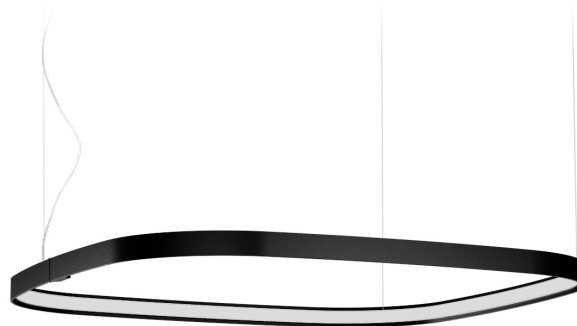

Einzel- oder Mehrfach-Pendelleuchte für Innenbereich, mit direkter und indirekter Abstrahlung.
Struktur aus gebogenem, stranggepresstem Aluminium mit Polyacrylfarbe in Weiß, Schwarz, Bronze, satiniertem Messing oder Titan.
Diffusor aus extrudiertem Polycarbonat mit Opal-Finish.
Aufhängungsset mit Schnellverstellvorrichtungen und 5m (196,9") Stahlseilen.
Transparentes PVC-Netzkabel 5m (196,9") lang.
Baldachin und Treiber sind nicht im Lieferumfang enthalten.

Technische Zeichnung

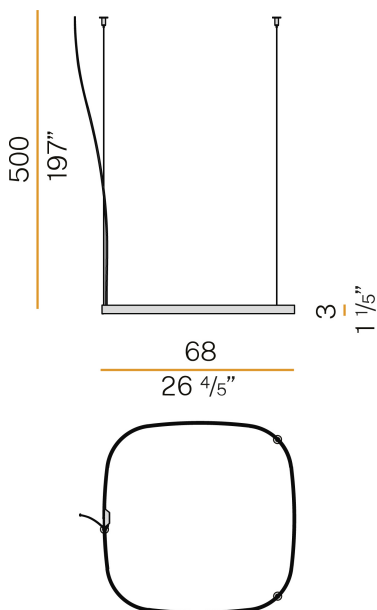

Lichtverteilungskurve

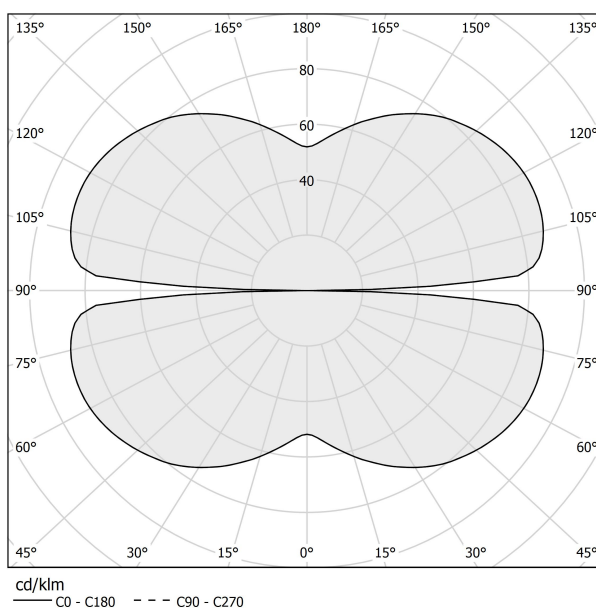

PANZERI

Zero Square

Zubehör / Stromversorgung

XM03302.511.0002

Baldachin für elektrischen Anschluss von 1 Modell Zero Shapes, mit Treiber DALI/Push DIM.



4,1
1 9/16"



20,6
8 1/8"

XM03302.522.0002

Baldachin für elektrischen Anschluss von 2 Modellen Zero Shapes, mit Treiber DALI/Push DIM.



9,8
1 1/2"



32,5
12 1/4"

XM03302.523.0002

Baldachin für elektrischen Anschluss von 3 Modellen Zero Shapes, mit Treiber DALI/Push DIM.



9,8
1 1/2"



32,5
12 1/4"

XM03302.524.0002

Baldachin für elektrischen Anschluss von 4 Modellen Zero Shapes, mit Treiber DALI/Push DIM.



9,8
1 1/2"













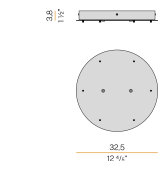

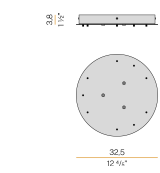



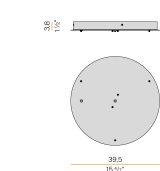

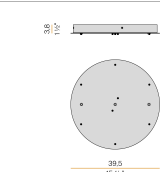





















32,5
12 1/4"

PANZERI

Zero Square

Zubehör / Stromversorgung und Befestigung

XM03302.531.0002	Baldachin für elektrischen Anschluss und Aufhängung von 1 Modell Zero Shapes Horizontal, mit Treiber DALI/Push DIM.	 4.1 10.6
   		 20.6 52.5
XM03302.532.0002	Baldachin für elektrischen Anschluss und Aufhängung von 2 Modellen Zero Shapes Horizontal, mit Treiber DALI/Push DIM.	 3.8 9.7
   		 32.5 82.5
XM03302.533.0002	Baldachin für elektrischen Anschluss und Aufhängung von 3 Modellen Zero Shapes Horizontal, mit Treiber DALI/Push DIM.	 3.8 9.7
   		 32.5 82.5
XM03302.534.0002	Baldachin für elektrischen Anschluss und Aufhängung von 4 Modellen Zero Shapes Horizontal, mit Treiber DALI/Push DIM.	 3.8 9.7
   		 32.5 82.5
XM03402.552.0002	Baldachin für elektrischen Anschluss und Aufhängung von 1 Modell Zero Shapes Horizontal und 1 Modell Zero Round Vertical, mit Treiber DALI/Push DIM.	 3.8 9.7
   		 39.5 100.2
XM03402.553.0002	Baldachin für elektrischen Anschluss und Aufhängung von 2 Modellen Zero Shapes Horizontal und 1 Modell Zero Round Vertical, mit Treiber DALI/Push DIM.	 3.8 9.7
   		 39.5 100.2
XM03402.554.0002	Baldachin für elektrischen Anschluss und Aufhängung von 2 Modellen Zero Shapes Horizontal und 2 Modellen Zero Round Vertical, mit Treiber DALI/Push DIM.	 3.8 9.7
   		 39.5 100.2