

PANZERI

Astoria 5

48V DC dimmbar (DALI/Push DIM)

B43202.005.1719

● Schwarz

Technisches Datenblatt

ARTIKELCODE	B43202.005.1719
LEISTUNGS-AUFNAHME DES SYSTEMS	8,4W
LICHTAUSBEUTE	73.75lm/W
LICHTQUELLE	LED
LICHTFARBTEMPERATUR	2700K Ra>90
LICHTVERTEILUNG	Verstellbar
ABSTRAHLWINKEL	24°
STROMVERSORGUNG	48V DC
ELEKTRIFIZIERUNG	dimmbar (DALI/Push DIM)
TREIBER	externer Treiber nicht enthalten
NENNLICHTSTROM	695lm
NUTZLICHTSTROM	590lm
EFFIZIENZ	84.9%
GEWICHT	0,13 Kg
SCHUTZART	IP20
VERPACKUNGSABMESSUNGEN	17,0 x 8,5 x 13,0 cm



Leuchte für die Innenmontage an einer Stromschiene, mit verstellbarem Lichtkegel. Gelenk aus Aluminiumdruckguss und zweiachsig schwenkbare Struktur. Blendfreier Zylinder und mittelstrahlende Linse aus thermoplastischem Material. Geliefert komplett mit elektrischem und mechanischem Adapter für die Installation auf elektrischen Niederspannungsschienen mit 48 V. Erhältlich in den Ausführungen 2700K und 3000K, in den Farben Weiß, Schwarz, Messing satiniert, Bronze und Titan, mit schwarzem Arm und hinterer Abdeckung.

Technische Zeichnung

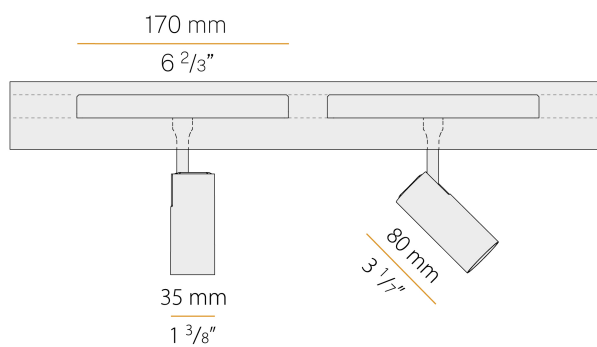

Lichtverteilungskurve

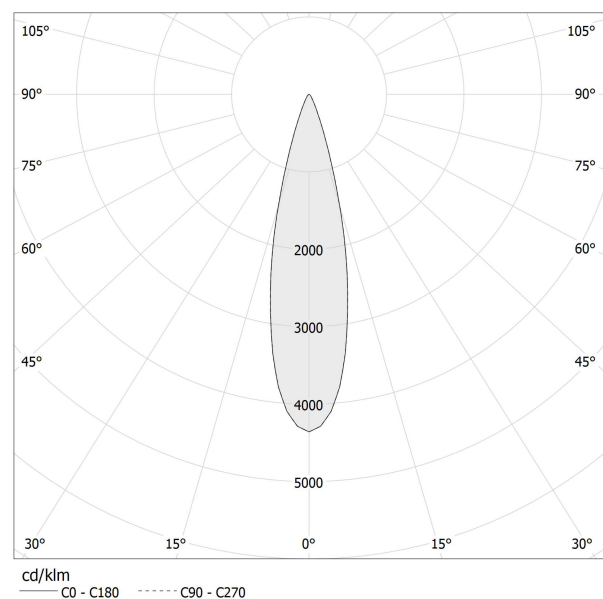

PANZERI

Astoria 5

Zubehör / Stromschienen

9500-2/B-ST2-E

48V DC DALI Hänge- oder Deckenstromschiene, Länge 2000mm (78.7").

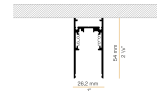

9500-2/B-ST5-E

48V DC DALI eingebaute Stromschiene, Länge 2000mm (78.7").

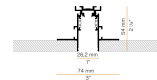

PANZERI

Astoria 5

Zubehör / Stromschienen / Stromversorgung

9500/P-100E-B-C1-N

Stromversorgungssatz mit Rosette für Deckenstromschienen, mit 100W/48V Treiber und Stromversorgungskopf. Kabellänge 200 mm (7.87").

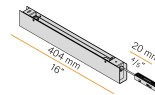

9500/P-100E-B-SP-N

Stromversorgungssatz mit Deckenrosette für Hänge- oder Deckenstromschiene, mit 100W/48V Treiber und Stromversorgungskopf. Kabellänge 2000 mm (78.7").

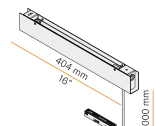

YBE41002.DV1

Integrierte Stromversorgung für 48V DC, 100W, DALI.

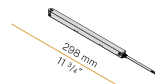

YDV.048.075.A01

LED Treiber, 75W 48V DC, on/off.

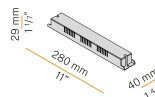

YDV.048.150.A01

LED Treiber, 150W 24V DC, on/off.

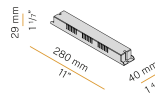

PANZERI

Astoria 5

Zubehör / Stromschienen / Stromversorgung und Verschluss

9501-S/B-E

Kopf Stromversorgung für 48V DC DALI Stromschiene.

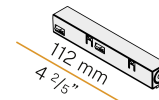

PANZERI

Astoria 5

Zubehör / Stromschienen / Verschluss

9504/ST2-B

Endkappe für 48V DC Stromschiene, ohne Bohrung.

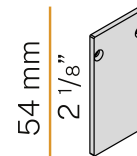

9504/ST2-B-F

Endkappen für 48V DC Stromschiene mit Bohrung.

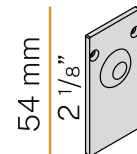

S-9500-L/B-2000

Schutzabdeckung für die Installation einer eingebauten Stromschiene. Länge 2000mm (78.7").

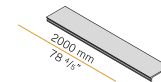

S-9500/LE-B-3000

Ästhetische Abdeckung mit einer Länge von 3000mm (118.1") für 48V DC Stromschiene.

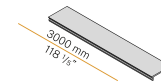

PANZERI

Astoria 5

Zubehör / Stromschienen / Befestigung

9500-KIT1-3

Endaufhängung-Bausatz, mit 3000mm (118.1") Stahldrahtseil für Stromschiene.

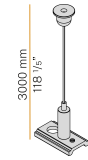

S-9000-P4

Aufhängungssatz für Unterputzschiene mit starrer Schiene Länge 1000mm (39.4").

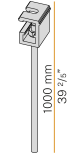

S-9000/118

Clip zur schnellen Befestigung mit Spannschloss für starre Aufhängung tige.

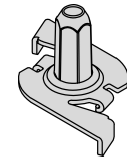

S-9500/114-B

Deckenbefestigungssatz für 48V DC Stromschiene.

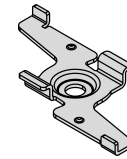

PANZERI

Astoria 5

Zubehör / Stromschienen / Verbindung

9503-S/B-E

Mechanische Linearverbindung für 48V DC DALI Stromschiene.

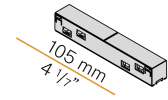

9511/B-E

"L"-Aussenverbindung für 48V DC DALI Stromschiene.

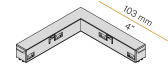

9518-S/B-E

Flexible Verbindung für 48V DC DALI Stromschiene.

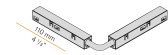

S-9500/314-B

Mechanische Linearverbindung für 48V DC eingebaute Stromschiene.

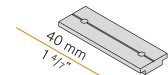

S-9500/323-SV

Mechanische Linearverbindung für 48V DC eingebaute Stromschiene.

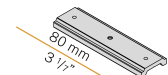

S-9511-I/B-ST5

"L" Mechanische Innenverbindung für 48V DC Wand-oder Decken-Einbaustrommaschine, ohne Rand.

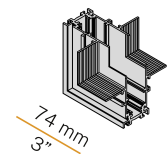

S-9511/B-ST2

"L"-Aussenverbindung für 48V Stromschienen Hänge- oder Deckenstromschiene.

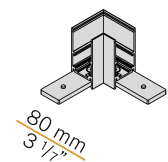

S-9511/B-ST5

Mechanische 'L'-Verbindung für 48V DC eingebaute Stromschiene ohne Rand.

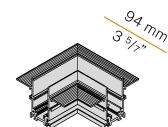

PANZERI

Astoria 5

Zubehör / Stromschienen / Befestigung und Verbindung

9500-KIT2-3

Befestigungs- und Verbindungssatz für Hängestromschiene, mit 3000mm (118,1") Stahldrahtseil.

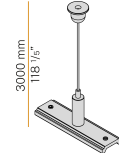

PANZERI

Astoria 5

Zubehör / Stromschienen / Signalsteuerung

YRS.B048.A16

Repeater-Gerät zur Opto-Isolierung des Datenbusses für 48V DC Stromschiene, 100W, DALI.

